



QUIETCOMFORT SE HEADPHONES

Please read and keep all safety, security, and use instructions.



Bose Corporation hereby declares that this product is in compliance with the essential requirements and other relevant provisions of Directive 2014/53/EU and all other applicable EU directive requirements. The complete declaration of conformity can be found at: www.Bose.com/compliance



This product conforms to all applicable Electromagnetic Compatibility Regulations 2016 and all other applicable UK regulations. The complete declaration of conformity can be found at: www.Bose.com/compliance

Bose Corporation hereby declares that this product is in compliance with the essential requirements per Radio Equipment Regulations 2017 and all other applicable UK regulations. The complete declaration of conformity can be found at: www.Bose.com/compliance

Important Safety Instructions

Do not use this apparatus near water.

Clean only with a dry cloth.

Refer all servicing to qualified personnel. Servicing is required when the apparatus has been damaged in any way, such as power-supply cord or plug is damaged, liquid has been spilled or objects have fallen into the apparatus, the apparatus has been exposed to rain or moisture, does not operate normally, or has been dropped.

WARNINGS/CAUTIONS

- Do NOT use the headphones at a high volume for any extended period.
 - To avoid hearing damage, use your headphones at a comfortable, moderate volume level.
 - Turn the volume down on your device before placing the headphones in/on your ears, then turn the volume up gradually until you reach a comfortable listening level.
- Do NOT use your headphones while driving for phone calls or any other purpose.
- Do NOT use the headphones with noise canceling mode at any time the inability to hear surrounding sounds may present a danger to yourself or others, e.g., while riding a bicycle or walking in or near traffic, a construction site or railroad, etc., and follow applicable laws regarding headphone use.
 - Turn the headphones off, or use the headphones with noise canceling off and adjust your volume, to ensure you can hear surrounding sounds, including alarms and warning signals.
 - Be aware of how sounds that you rely on as reminders or warnings may vary in character when using the headphones, even with Aware mode.
- Do NOT use the headphones if they emit any loud unusual noise. If this happens, turn the headphones off and contact Bose customer service.
- Remove headphones immediately if you experience a warming sensation or loss of audio.
- Do NOT use mobile phone adapters to connect headphones to airplane seat jacks, as this could result in injury or property damage due to overheating.
- Do NOT use the headphones as aviation communication headsets.



Contains small parts which may be a choking hazard. Not suitable for children under age 3.



This product contains magnetic material. Consult your physician on whether this might affect your implantable medical device.

IMPORTANT SAFETY INSTRUCTIONS

- To reduce the risk of fire or electrical shock, do NOT expose this product to rain, dripping, splashing, or moisture and do not place liquid filled objects such as vases, on or near the product.
- Keep the product away from fire and heat sources. Do NOT place naked flame sources, such as lighted candles, on or near the product.
- Use this product only with an agency approved LPS power supply which meets local regulatory requirements (e.g., UL, CSA, VDE, CCC).
- Do NOT make unauthorized alterations to this product.
- If the battery leaks, do not allow the liquid to come in contact with the skin or eyes. If contact is made, seek medical advice.
- Do not expose products containing batteries to excessive heat (e.g. from storage in direct sunlight, fire or the like).
- Do NOT wear while charging.

NOTE: This equipment has been tested and found to comply with the limits for a Class B digital device, pursuant to Part 15 of the FCC Rules. These limits are designed to provide reasonable protection against harmful interference in a residential installation. This equipment generates, uses, and can radiate radio frequency energy and, if not installed and used in accordance with the instructions, may cause harmful interference to radio communications. However, there is no guarantee that interference will not occur in a particular installation. If this equipment does cause harmful interference to radio or television reception, which can be determined by turning the equipment off and on, the user is encouraged to try to correct the interference by one or more of the following measures:

- Reorient or relocate the receiving product or antenna.
- Increase the separation between the equipment and receiver.
- Connect the equipment into an outlet on a circuit different from that to which the receiver is connected.
- Consult the dealer or an experienced radio/TV technician for help.

Changes or modifications not expressly approved by Bose Corporation could void the user's authority to operate this equipment.

This device complies with part 15 of the FCC Rules and with ISED Canada license-exempt RSS standard(s). Operation is subject to the following two conditions: (1) This device may not cause harmful interference, and (2) this device must accept any interference received, including interference that may cause undesired operation.

This device complies with FCC and ISED Canada radiation exposure limits set forth for general population. This transmitter must not be co-located or operating in conjunction with any other antenna or transmitter.

Meets IMDA Requirements.

FCC ID: A94437310

IC: 3232A-437310

CAN ICES-3(B)/NMB-3(B)

For Europe:

Frequency band of operation 2400 to 2483.5 MHz.

Maximum transmit power less than 20 dBm EIRP.

Maximum transmit power is below regulatory limits such that SAR testing is not necessary and exempt per applicable regulations.



This symbol means the product must not be discarded as household waste, and should be delivered to an appropriate collection facility for recycling. Proper disposal and recycling helps protect natural resources, human health and the environment. For more information on disposal and recycling of this product, contact your local municipality, disposal service, or the shop where you bought this product.

Low-power Radio-frequency Devices Technical Regulations

Without permission granted by the NCC, any company, enterprise, or user is not allowed to change frequency, enhance transmitting power or alter original characteristic as well as performance to a approved low power radio-frequency devices. The low power radio-frequency devices shall not influence aircraft security and interfere legal communications; If found, the user shall cease operating immediately until no interference is achieved. The said legal communications means radio communications is operated in compliance with the Telecommunications Management Act. The low power radio-frequency devices must be susceptible with the interference from legal communications or ISM radio wave radiated devices.

DON'T attempt to remove the rechargeable lithium-ion battery from this product. Contact your local Bose retailer or other qualified professional for removal.

Removal of the rechargeable lithium-ion battery in this product should be conducted only by a qualified professional. Please contact your local Bose retailer or see products.bose.com/static/compliance/index.html for further information.



Please dispose of used batteries properly, following local regulations. Do not incinerate.



Names and Contents of Toxic or Hazardous Substances or Elements						
Part Name	Toxic or Hazardous Substances and Elements					
	Lead (Pb)	Mercury (Hg)	Cadmium (Cd)	Hexavalent (CR(VI))	Polybrominated Biphenyl (PBB)	Polybrominated diphenylether (PBDE)
PCBs	X	0	0	0	0	0
Metal Parts	X	0	0	0	0	0
Plastic Parts	0	0	0	0	0	0
Speaker	X	0	0	0	0	0
Cables	X	0	0	0	0	0
This table is prepared in accordance with the provisions of SJ/T 11364. 0: Indicates that this toxic or hazardous substance contained in all of the homogeneous materials for this part is below the limit requirement of GB/T 26572. X: Indicates that this toxic or hazardous substance contained in at least one of the homogeneous materials used for this part is above the limit requirement of GB/T 26572.						

Date of Manufacture: The eighth digit in the serial number indicates the year of manufacture; “2” is 2012 or 2022.

China Importer: Bose Electronics (Shanghai) Company Limited, Level 6, Tower D, No. 2337 Gudai Rd. Minhang District, Shanghai 201100

EU Importer: Bose Products B.V., Gorslaan 60, 1441 RG Purmerend, The Netherlands

Mexico Importer: Bose de México S. de R.L. de C.V., Avenida Prado Sur #150, Piso 2, Interior 222 y 223, Colonia Lomas de Chapultepec V Sección, Miguel Hidalgo, Ciudad de México, C.P. 11000 Phone Number: +5255 (5202) 3545

Taiwan Importer: Bose Limited Taiwan Branch (H.K.), 9F., No. 10, Sec. 3, Minsheng E. Road, Zhongshan Dist. Taipei City 10480, Taiwan Phone Number: +886-2-2514 7676

UK Importer: Bose Limited, Bose House, Quayside Chatham Maritime, Chatham, Kent, ME4 4QZ, United Kingdom

Input Rating: 5 V --- 0.5 A

Charging Temperature Range: 32° F to 113° F (0° C to 45° C)

Discharging Temperature Range: -4° F to 140° F (-20° C to 60° C)

Model 437310. The CMIIT ID is located inside the earcup under the scrim.

Please complete and retain for your records

The serial and model numbers are located inside the earcup under the scrim.

Serial number: _____

Model number: _____

Please keep your receipt with your owner’s guide. Now is a good time to register your Bose product. You can easily do this by going to worldwide.bose.com/ProductRegistration

Security Information



This product is capable of receiving security updates from Bose automatically when connected to the Bose Music app. In order to receive security updates via the mobile application, you must complete the product setup process in the Bose Music app. **If you do not complete the setup process, you will be responsible for installing security updates that Bose makes available via btu.bose.com**

Apple, the Apple logo, iPad, iPhone, and iPod are trademarks of Apple Inc., registered in the U.S. and other countries. App Store is a service mark of Apple Inc. The trademark "iPhone" is used in Japan with a license from Aiphone K.K.

Use of the Made for Apple badge means that an accessory has been designed to connect specifically to the Apple product(s) identified in the badge, and has been certified by the developer to meet Apple performance standards. Apple is not responsible for the operation of this device or its compliance with safety and regulatory standards.

The *Bluetooth*[®] word mark and logos are registered trademarks owned by Bluetooth SIG, Inc. and any use of such marks by Bose Corporation is under license.

Google Play is a trademark of Google LLC.

USB Type-C[®] and USB-C[®] are registered trademarks of USB Implementers Forum.

Bose, Bose Home Speaker, Bose Music, the Bose Music logo, Bose Smart Soundbar, Bose Smart Speaker, Bose Soundbar, QuietComfort, and SimpleSync are trademarks of Bose Corporation.

Bose Corporation Headquarters: 1-877-230-5639

©2022 Bose Corporation. No part of this work may be reproduced, modified, distributed, or otherwise used without prior written permission.

The following license disclosures apply to certain third-party software packages used as components in the product.

Package: FreeRTOS

Copyright © Amazon Web Services, Inc. or its affiliates. All rights reserved.

The FreeRTOS package is subject to the license terms reprinted below:

MIT License

Permission is hereby granted, free of charge, to any person obtaining a copy of this software and associated documentation files (the “Software”), to deal in the Software without restriction, including without limitation the rights to use, copy, modify, merge, publish, distribute, sublicense, and/or sell copies of the Software, and to permit persons to whom the Software is furnished to do so, subject to the following conditions:

The above copyright notice and this permission notice shall be included in all copies or substantial portions of the Software.

THE SOFTWARE IS PROVIDED “AS IS”, WITHOUT WARRANTY OF ANY KIND, EXPRESS OR IMPLIED, INCLUDING BUT NOT LIMITED TO THE WARRANTIES OF MERCHANTABILITY, FITNESS FOR A PARTICULAR PURPOSE AND NONINFRINGEMENT. IN NO EVENT SHALL THE AUTHORS OR COPYRIGHT HOLDERS BE LIABLE FOR ANY CLAIM, DAMAGES OR OTHER LIABILITY, WHETHER IN AN ACTION OF CONTRACT, TORT OR OTHERWISE, ARISING FROM, OUT OF OR IN CONNECTION WITH THE SOFTWARE OR THE USE OR OTHER DEALINGS IN THE SOFTWARE.

Package: Nanopb

Copyright © 2011 Petteri Aimonen <jpa at nanopb.mail.kapsi.fi>.

The Nanopb package is subject to the license terms reprinted below:

Zlib License

© 2011 Petteri Aimonen <jpa at nanopb.mail.kapsi.fi>

This software is provided ‘as-is’, without any express or implied warranty. In no event will the authors be held liable for any damages arising from the use of this software.

Permission is granted to anyone to use this software for any purpose, including commercial applications, and to alter it and redistribute it freely, subject to the following restrictions:

1. The origin of this software must not be misrepresented; you must not claim that you wrote the original software. If you use this software in a product, an acknowledgment in the product documentation would be appreciated but is not required.
2. Altered source versions must be plainly marked as such, and must not be misrepresented as being the original software.
3. This notice may not be removed or altered from any source distribution.

Package: Mbed TLS 2.16.1

© ARM Limited. All rights reserved.

The Mbed TLS package is subject to the license terms reprinted below:

Apache License

Version 2.0, January 2004

<http://www.apache.org/licenses/>

TERMS AND CONDITIONS FOR USE, REPRODUCTION, AND DISTRIBUTION

1. Definitions.
“License” shall mean the terms and conditions for use, reproduction, and distribution as defined by Sections 1 through 9 of this document.

“Licensor” shall mean the copyright owner or entity authorized by the copyright owner that is granting the License.

“Legal Entity” shall mean the union of the acting entity and all other entities that control, are controlled by, or are under common control with that entity. For the purposes of this definition, “control” means (i) the power, direct or indirect, to cause the direction or management of such entity, whether by contract or otherwise, or (ii) ownership of fifty percent (50%) or more of the outstanding shares, or (iii) beneficial ownership of such entity.

“You” (or “Your”) shall mean an individual or Legal Entity exercising permissions granted by this License.

“Source” form shall mean the preferred form for making modifications, including but not limited to software source code, documentation source, and configuration files.

“Object” form shall mean any form resulting from mechanical transformation or translation of a Source form, including but not limited to compiled object code, generated documentation, and conversions to other media types.

“Work” shall mean the work of authorship, whether in Source or Object form, made available under the License, as indicated by a copyright notice that is included in or attached to the work (an example is provided in the Appendix below).

“Derivative Works” shall mean any work, whether in Source or Object form, that is based on (or derived from) the Work and for which the editorial revisions, annotations, elaborations, or other modifications represent, as a whole, an original work of authorship. For the purposes of this License, Derivative Works shall not include works that remain separable from, or merely link (or bind by name) to the interfaces of, the Work and Derivative Works thereof.

“Contribution” shall mean any work of authorship, including the original version of the Work and any modifications or additions to that Work or Derivative Works thereof, that is intentionally submitted to Licensor for inclusion in the Work by the copyright owner or by an individual or Legal Entity authorized to submit on behalf of the copyright owner. For the purposes of this definition, “submitted” means any form of electronic, verbal, or written communication sent to the Licensor or its representatives, including but not limited to communication on electronic mailing lists, source code control systems, and issue tracking systems that are managed by, or on behalf of, the Licensor for the purpose of discussing and improving the Work, but excluding communication that is conspicuously marked or otherwise designated in writing by the copyright owner as “Not a Contribution.”

“Contributor” shall mean Licensor and any individual or Legal Entity on behalf of whom a Contribution has been received by Licensor and subsequently incorporated within the Work.

2. Grant of Copyright License. Subject to the terms and conditions of this License, each Contributor hereby grants to You a perpetual, worldwide, non-exclusive, no-charge, royalty-free, irrevocable copyright license to reproduce, prepare Derivative Works of, publicly display, publicly perform, sublicense, and distribute the Work and such Derivative Works in Source or Object form.
3. Grant of Patent License. Subject to the terms and conditions of this License, each Contributor hereby grants to You a perpetual, worldwide, non-exclusive, no-charge, royalty-free, irrevocable (except as stated in this section) patent license to make, have made, use, offer to sell, sell, import, and otherwise transfer the Work, where such license applies only to those patent claims licensable by such Contributor that are necessarily infringed by their Contribution(s) alone or by combination of their Contribution(s) with the Work to which such Contribution(s) was submitted. If You institute patent litigation against any entity (including a cross-claim or counterclaim in a lawsuit) alleging that the Work or a Contribution incorporated within the Work constitutes direct or contributory patent infringement, then any patent licenses granted to You under this License for that Work shall terminate as of the date such litigation is filed.
4. Redistribution. You may reproduce and distribute copies of the Work or Derivative Works thereof in any medium, with or without modifications, and in Source or Object form, provided that You meet the following conditions:
 - a. You must give any other recipients of the Work or Derivative Works a copy of this License; and
 - b. You must cause any modified files to carry prominent notices stating that You changed the files; and
 - c. You must retain, in the Source form of any Derivative Works that You distribute, all copyright, patent, trademark, and attribution notices from the Source form of the Work, excluding those notices that do not pertain to any part of the Derivative Works; and

d. If the Work includes a “NOTICE” text file as part of its distribution, then any Derivative Works that You distribute must include a readable copy of the attribution notices contained within such NOTICE file, excluding those notices that do not pertain to any part of the Derivative Works, in at least one of the following places: within a NOTICE text file distributed as part of the Derivative Works; within the Source form or documentation, if provided along with the Derivative Works; or, within a display generated by the Derivative Works, if and wherever such third-party notices normally appear. The contents of the NOTICE file are for informational purposes only and do not modify the License. You may add Your own attribution notices within Derivative Works that You distribute, alongside or as an addendum to the NOTICE text from the Work, provided that such additional attribution notices cannot be construed as modifying the License.

You may add Your own copyright statement to Your modifications and may provide additional or different license terms and conditions for use, reproduction, or distribution of Your modifications, or for any such Derivative Works as a whole, provided Your use, reproduction, and distribution of the Work otherwise complies with the conditions stated in this License.

5. Submission of Contributions. Unless You explicitly state otherwise, any Contribution intentionally submitted for inclusion in the Work by You to the Licensor shall be under the terms and conditions of this License, without any additional terms or conditions. Notwithstanding the above, nothing herein shall supersede or modify the terms of any separate license agreement you may have executed with Licensor regarding such Contributions.
6. Trademarks. This License does not grant permission to use the trade names, trademarks, service marks, or product names of the Licensor, except as required for reasonable and customary use in describing the origin of the Work and reproducing the content of the NOTICE file.
7. Disclaimer of Warranty. Unless required by applicable law or agreed to in writing, Licensor provides the Work (and each Contributor provides its Contributions) on an “AS IS” BASIS, WITHOUT WARRANTIES OR CONDITIONS OF ANY KIND, either express or implied, including, without limitation, any warranties or conditions of TITLE, NON-INFRINGEMENT, MERCHANTABILITY, or FITNESS FOR A PARTICULAR PURPOSE. You are solely responsible for determining the appropriateness of using or redistributing the Work and assume any risks associated with Your exercise of permissions under this License.
8. Limitation of Liability. In no event and under no legal theory, whether in tort (including negligence), contract, or otherwise, unless required by applicable law (such as deliberate and grossly negligent acts) or agreed to in writing, shall any Contributor be liable to You for damages, including any direct, indirect, special, incidental, or consequential damages of any character arising as a result of this License or out of the use or inability to use the Work (including but not limited to damages for loss of goodwill, work stoppage, computer failure or malfunction, or any and all other commercial damages or losses), even if such Contributor has been advised of the possibility of such damages.
9. Accepting Warranty or Additional Liability. While redistributing the Work or Derivative Works thereof, You may choose to offer, and charge a fee for, acceptance of support, warranty, indemnity, or other liability obligations and/or rights consistent with this License. However, in accepting such obligations, You may act only on Your own behalf and on Your sole responsibility, not on behalf of any other Contributor, and only if You agree to indemnify, defend, and hold each Contributor harmless for any liability incurred by, or claims asserted against, such Contributor by reason of your accepting any such warranty or additional liability.

END OF TERMS AND CONDITIONS

©2022 Bose Corporation

Licensed under the Apache License, Version 2.0 (the “License”); you may not use this file except in compliance with the License.

You may obtain a copy of the License at: <http://www.apache.org/licenses/LICENSE-2.0>

Unless required by applicable law or agreed to in writing, software distributed under the License is distributed on an “AS IS” BASIS, WITHOUT WARRANTIES OR CONDITIONS OF ANY KIND, either express or implied.

See the License for the specific language governing permissions and limitations under the License.

WHAT'S IN THE BOX

Contents 13

BOSE MUSIC APP

Download the Bose Music app 14
 Add the headphones to an existing account 14

HEADPHONE CONTROLS

Power on 16
 Standby timer 16
 Power off 17
 Headphone functions 18
 Media playback and volume 18
 Phone calls 19
 Action button 20

NOISE CANCELLATION

Noise cancelling modes 21
 Change the noise cancelling mode 21

VOICE CONTROL

Access voice control 22

BLUETOOTH® CONNECTIONS

Connect using the *Bluetooth* menu on your mobile device 23
 Disconnect a mobile device 25
 Reconnect a mobile device 25
 Connect another mobile device 25
 Identify connected mobile devices 25
 Switch between two connected mobile devices 25
 Reconnect a previously connected device 26
 Clear the headphone device list 26

WIRED CONNECTIONS

Connect the audio cable..... 27

BATTERY

Charge the headphones..... 28
 Charging time..... 28
 Hear the battery level 28

HEADPHONE STATUS

Bluetooth status 29
 Battery status 29
 Charging status 30
 Update and error status 30

CONNECT BOSE PRODUCTS

Connect a Bose Smart Speaker or Soundbar..... 31
 Benefits..... 31
 Compatible products 31
 Connect using the Bose Music app 31
 Reconnect to a Bose Smart Speaker or Soundbar..... 32

CARE AND MAINTENANCE

Store the headphones..... 33
 Clean the headphones 34
 Replacement parts and accessories..... 34
 Limited warranty 34
 Serial number location..... 35

TROUBLESHOOTING

Try these solutions first 36

Other solutions 36

Restore the headphones to factory settings 39

CONTENTS

Confirm that the following parts are included:



Bose QuietComfort 45 headphones

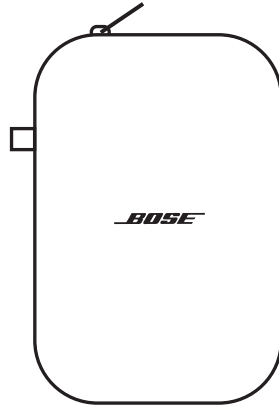

Soft carry case



USB Type-C® cable

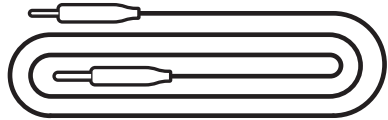

3.5 mm to 2.5 mm audio cable

NOTE: If any part of your product is damaged, do not use it. Contact your authorized Bose dealer or Bose customer service.

Visit: support.Bose.com/QCSE

The Bose Music app lets you set up and control the headphones from any mobile device, such as a smartphone or tablet.

Using the app, you can manage *Bluetooth* connections, manage headphone settings, choose your voice prompt language, and access new features through updates.

NOTE: If you've already created a Bose Music account for another Bose product, add the headphones to your existing account (see the bottom of page 14).

DOWNLOAD THE BOSE MUSIC APP

1. On your mobile device, download the Bose Music app.

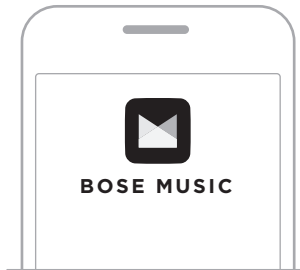

2. Follow the app instructions.

ADD THE HEADPHONES TO AN EXISTING ACCOUNT

To add your Bose QuietComfort 45 headphones, open the Bose Music app and add your headphones.

HEADPHONE CONTROLS

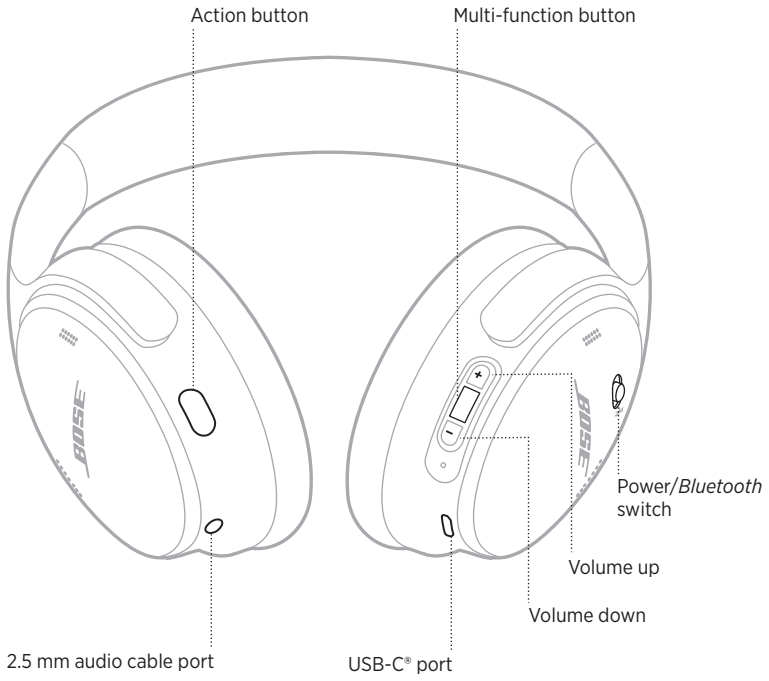

POWER ON

On the right earcup, slide the *Power/Bluetooth* switch to the right.

A voice prompt announces the battery level, and the status light glows according to the current charge level (see page 29).



Standby timer

The standby timer conserves the battery when the headphones are not being used.

To set up and customize the standby timer, use the Bose Music app.

POWER OFF

Slide the Power/*Bluetooth* switch to the left.



NOTE: When the headphones are powered off, noise cancellation is disabled.

HEADPHONE FUNCTIONS

The headphone controls are located on the back of the right earcup.

Media playback and volume

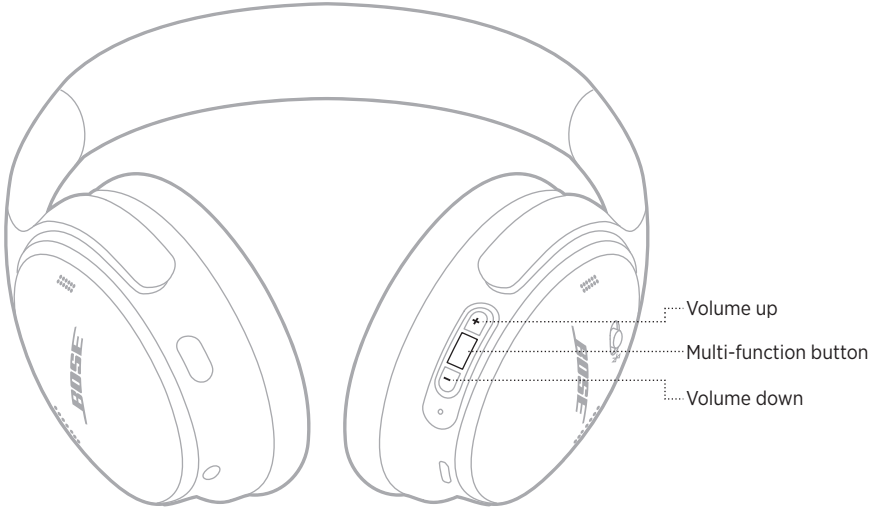

FUNCTION	WHAT TO DO
Play/Pause	Press the Multi-function button.
Skip forward	Double-press the Multi-function button.
Skip backward	Triple-press the Multi-function button.
Volume up	Press +.
Volume down	Press —.

NOTES:

- To quickly increase the volume, press and hold +.
- To quickly decrease the volume, press and hold —.

Phone calls

The Multi-function button is located on the back of the right earcup. The microphone is located near the front of the right earcup.

The Action button is located on the back of the left earcup.

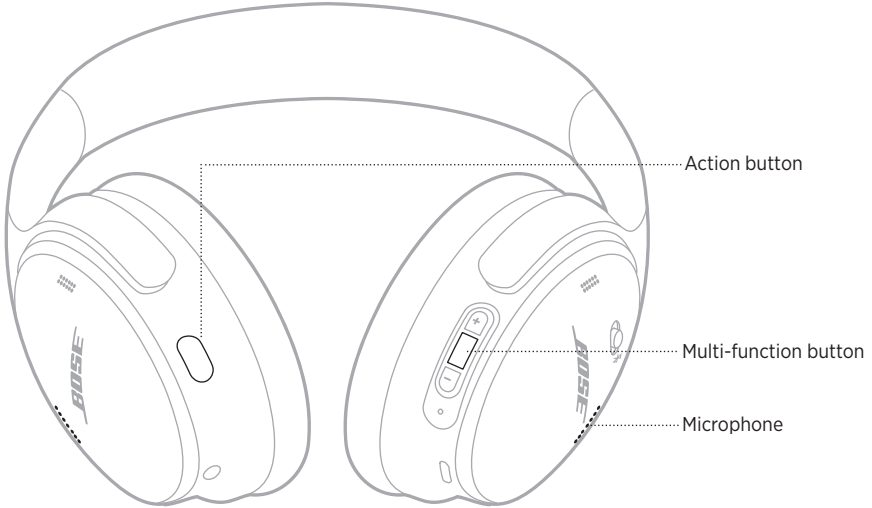

FUNCTION	WHAT TO DO
Answer/End a call	Press the Multi-function button.
Decline an incoming call	Press and hold the Multi-function button for 1 second.
Answer a second incoming call and put the current call on hold	While on a call and a second incoming call is ringing, press the Multi-function button.
Decline a second incoming call and stay on current call	While on a call and a second incoming call is ringing, press and hold the Multi-function button for 1 second.
Switch between two calls	While two calls are active, double-press the Multi-function button.
Create a conference call	While two calls are active, press and hold the Multi-function button for 3 seconds.
Mute/Unmute a call	While on a call, double-press the Action button.

Action button

The Action button allows you to quickly and easily switch between noise cancelling modes.

The Action button is located on the back of the left earcup.

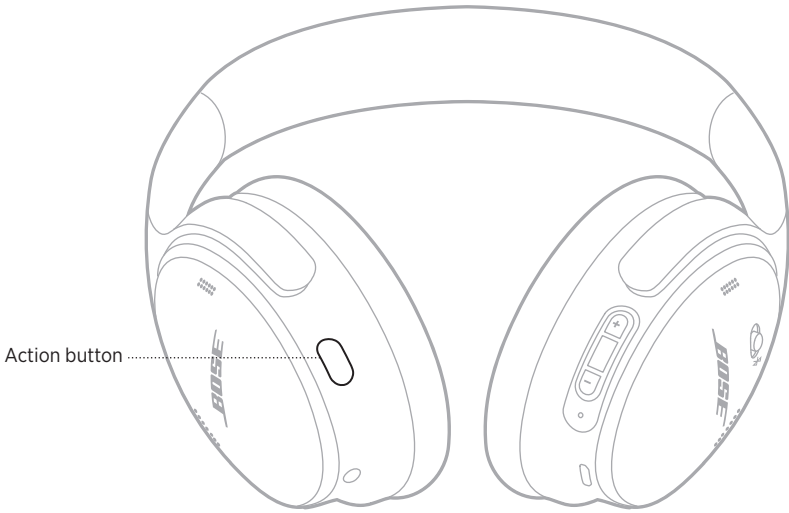

To switch between Quiet Mode and Aware Mode, press the Action button.

For information about noise cancelling modes, see page 21.

Noise cancelling reduces unwanted noise, providing a clearer and more lifelike audio performance. You can choose between two noise cancelling modes: Quiet and Aware.

Quiet Mode allows you to block out distractions using the highest level of noise cancellation.

Aware Mode provides full transparency and allows you to hear your surroundings while enjoying your audio.

Choose your noise cancelling mode based on your listening preferences and environment.

NOISE CANCELLING MODES

MODE	DESCRIPTION
Quiet	World-class noise cancellation with Bose-optimized audio.
Aware	Hear your surroundings while enjoying your audio.

NOTE: When powered on, the headphones default to the last mode you used.

CHANGE THE NOISE CANCELLING MODE

To change the noise cancelling mode, press the Action button.

A voice prompt announces the selected noise cancelling mode.

TIP: You can also change the noise cancelling mode using the Bose Music app.

ACCESS VOICE CONTROL

You can use the headphones to access voice control on your mobile device. To access voice control, press and hold the Multi-function button for 1 second.

The Multi-function button is located on the back of the right earcup.

NOTE: You can't access voice control while on a call.

CONNECT USING THE *BLUETOOTH* MENU ON YOUR MOBILE DEVICE

You can store up to eight devices in the headphone device list, and the headphones can be actively connected to two devices at a time. You can play audio from only one device at a time.

NOTE: For the best experience, use the Bose Music app to set up and connect your mobile device (see page 14).

1. Slide the *Power/Bluetooth* switch to the right  and hold for 3 seconds.

You hear “Ready to connect,” and the status light blinks blue.



2. On your device, enable the *Bluetooth* feature.

NOTE: The *Bluetooth* feature is usually found in the Settings menu.

3. Select your headphones from the device list.

TIP: Look for the name you entered for your headphones in the Bose Music app. If you didn't name your headphones, the default name appears.

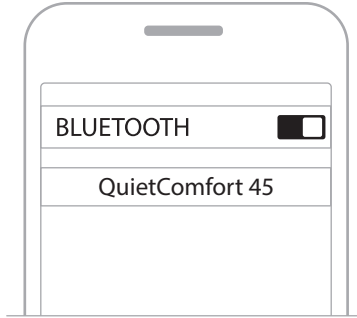

Once connected, you hear “Connected to <device name>,” and the status light glows solid blue for 10 seconds.

DISCONNECT A MOBILE DEVICE

Use the Bose Music app to disconnect your mobile device.

TIP: You can also use *Bluetooth* settings to disconnect your device. Disabling the *Bluetooth* feature disconnects all other devices.

RECONNECT A MOBILE DEVICE

When powered on, the headphones try to reconnect with the two most recently-connected devices.

NOTES:

- The device must be within range (30 ft or 9 m) and powered on.
- Make sure the *Bluetooth* feature is enabled on your mobile device.

CONNECT ANOTHER MOBILE DEVICE

To connect another device, download the Bose Music app (see page 14) or use the *Bluetooth* menu on your mobile device (see page 23).

NOTE: You can only play audio from one device at a time.

IDENTIFY CONNECTED MOBILE DEVICES

Slide the *Power/Bluetooth* switch to the right ⌘ and release to hear which device is currently connected.

SWITCH BETWEEN TWO CONNECTED MOBILE DEVICES

1. Pause audio on your first mobile device.
2. Play audio on your second mobile device.

NOTE: Your headphones receive phone calls from both devices, regardless of which device is playing audio.

RECONNECT A PREVIOUSLY CONNECTED DEVICE

1. Slide the *Power/Bluetooth* switch to the right ⌘ and release to hear which device is connected.
2. Within 2 seconds, slide the *Power/Bluetooth* switch to the right ⌘ and release again to connect to the next device in the headphone device list.
3. Repeat until you hear the correct device name.
You hear a tone that indicates when the device is connected.
4. Play audio on the connected mobile device.

NOTE: If two devices are already connected to the headphones, the newly-connected device replaces the second device that was previously connected.

CLEAR THE HEADPHONE DEVICE LIST

1. Slide the *Power/Bluetooth* switch to the right ⌘ and hold for 15 seconds, until you hear “*Bluetooth* device list cleared. Ready to connect.”
2. Delete your headphones from the *Bluetooth* list on your mobile device.
All devices are cleared and the headphones are ready to connect.

CONNECT THE AUDIO CABLE

Use the 2.5 mm to 3.5 mm cable to connect a non-wireless device or to continue using the headphones if the battery is depleted.

1. Connect the cable into the 2.5 mm port on the left earcup.



2. Connect the other end of the cable into the 3.5 mm port on your device.

NOTE: You can use the headphones powered on or off when the audio cable is connected.

CHARGE THE HEADPHONES

1. Connect the small end of the USB cable into the USB-C port on the right earcup.
2. Connect the other end into a USB wall charger.



NOTES:

- When the headphones begin charging, the status light blinks white for 10 seconds. When fully charged, the status light glows solid white.
- The headphones don't play while charging.

Charging time

Allow up to 2.5 hours to fully charge the headphones.

Hear the battery level

Each time you power on the headphones, a voice prompt announces the battery level. When the headphone battery is low, you hear "Battery low, please charge now."

NOTE: To visually check the battery, see the status light located on the right earcup. For more information, see "Battery status" on page 29.

The status light is located on the right earcup.



BLUETOOTH STATUS

Shows the *Bluetooth* connection status.

LIGHT ACTIVITY	SYSTEM STATE
Blinking blue	Ready to connect
Solid blue (10 seconds)	Connected

BATTERY STATUS

Shows the battery level.

LIGHT ACTIVITY	SYSTEM STATE
Solid white	Medium to full charge
Solid amber	Low charge

TIP: You can also check the battery level using the Bose Music app.

CHARGING STATUS

Shows the charging status.

LIGHT ACTIVITY	SYSTEM STATE
Blinks white 2 times	Charging begins
Solid amber	Charging
Solid white	Full charge

UPDATE AND ERROR STATUS

Shows the update or error status.

LIGHT ACTIVITY	SYSTEM STATE
Fast blinking white (10 seconds)	Updating software (via USB)
Slow blinking white (30 to 60 seconds)	Updating software (wirelessly)
Blinking amber and white	Error - contact Bose customer service

CONNECT A BOSE SMART SPEAKER OR SOUNDBAR

Using SimpleSync™ technology, you can connect the headphones to a Bose Smart Soundbar or Bose Smart Speaker for a personal listening experience.

Benefits

- Use independent volume controls on each product to lower or mute your Bose Smart Soundbar while keeping the headphones as loud as you like.
- Hear your music clearly from the next room by connecting the headphones to your Bose Smart Speaker.

NOTE: SimpleSync™ technology has a *Bluetooth* range of up to 30 ft (9 m). Walls and construction materials can affect reception.

Compatible products

You can connect the headphones to any Bose Smart Speaker or Bose Smart Soundbar.

Popular compatible products include:

- Bose Smart Soundbar 700/Bose Soundbar 700
- Bose Soundbar 500
- Bose Smart Speaker 500/Bose Home Speaker 500
- Bose Home Speaker 300
- Bose Portable Smart Speaker/Bose Portable Home Speaker

New products are added periodically. For a complete list and more information, visit: worldwide.bose.com/Support/Groups

Connect using the Bose Music app

1. On the headphones, slide the *Power/Bluetooth* switch to the right \times and hold for 3 seconds.

You hear “Ready to connect another device,” and the status light blinks blue.

2. Use the Bose Music app to connect the headphones to a compatible Bose product. For more information, visit: worldwide.bose.com/Support/Groups

NOTES:

- Make sure that the headphones are within 30 ft (9 m) of your soundbar or speaker.
- You can connect the headphones to only one product at a time.

RECONNECT TO A BOSE SMART SPEAKER OR SOUNDBAR

Power on the headphones (see “Power on” on page 16).

The headphones try to connect to the two most recently-connected *Bluetooth* devices, including your soundbar or speaker.

NOTES:

- Your soundbar or speaker must be within range (30 ft or 9 m) and powered on.
- If the headphones don't reconnect, see “Headphones don't reconnect to a previously-connected Bose Smart Soundbar or Speaker” on page 38.

STORE THE HEADPHONES

The earcups rotate for easy, convenient storage. Place the headphones flat into the case.

1. Rotate both earcups inward so they lay flat.

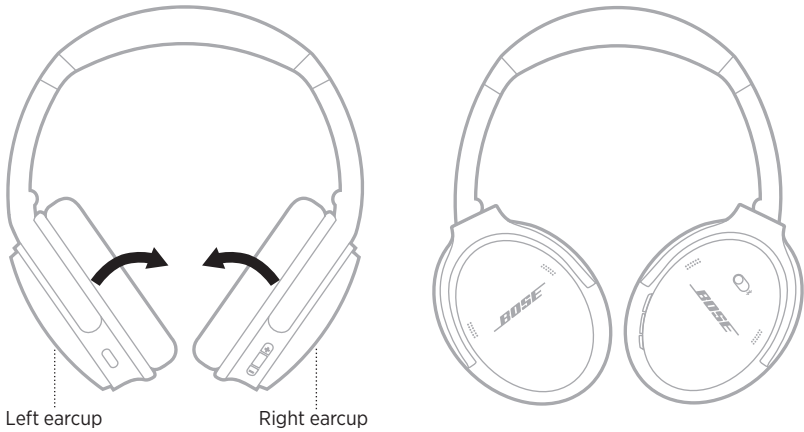

2. Fold the left earcup up toward the headband.

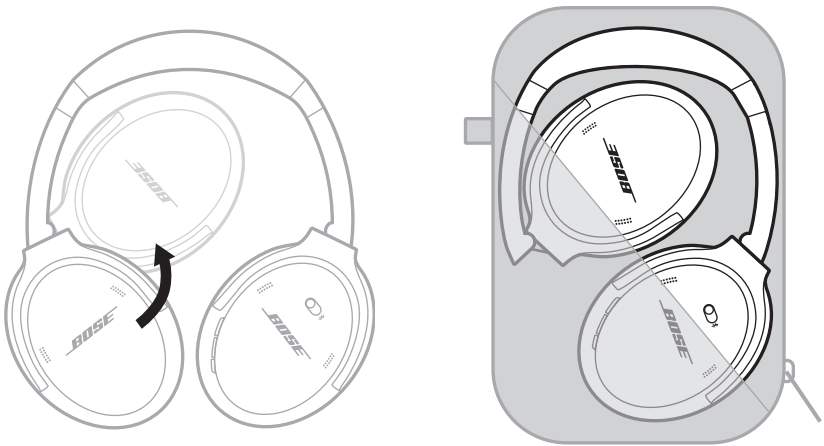

NOTES:

- Make sure to power off the headphones when not in use.
- Before storing the headphones for more than a few months, make sure the battery is fully charged.

CLEAN THE HEADPHONES

Wipe the outside surfaces with a soft, dry cloth.

Don't allow moisture to get inside the earcups.

REPLACEMENT PARTS AND ACCESSORIES

Replacement parts and accessories can be ordered through Bose customer service. Visit: support.Bose.com/QCSE

LIMITED WARRANTY

Your headphones are covered by a limited warranty. Visit our website at worldwide.Bose.com/Warranty for details of the limited warranty.

To register your product, visit worldwide.Bose.com/ProductRegistration for instructions. Failure to register will not affect your limited warranty rights.

SERIAL NUMBER LOCATION

The serial number is located inside the right earcup under the scrim. The scrim is the inner screen that covers and protects the components inside the earcup.

To view the serial number, grab the scrim at the top edge and gently peel it away.

CAUTION: Be careful not to press down on or remove any other components inside the earcup as this could damage the headphones.

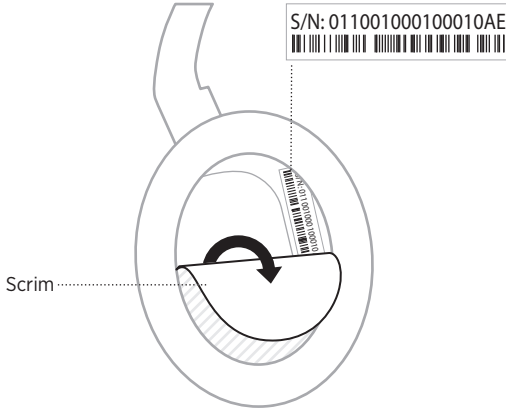

TRY THESE SOLUTIONS FIRST

If you experience problems with your headphones:

- Check the state of the status light (see page 29).
- Charge the battery (see page 28).
- Increase the volume on your headphones, mobile device, and music app.
- Download the Bose Music app and run available software updates (see page 14).
- Try connecting another mobile device (see page 25).

If you could not resolve your issue, see the table below to identify symptoms and solutions to common problems. If you are unable to resolve your issue, contact Bose customer service.

Visit: worldwide.bose.com/contact

OTHER SOLUTIONS

SYMPTOM	SOLUTION
Headphones don't power on	Charge the battery.
Headphones don't connect with your mobile device	<p>Disconnect the back-up audio cable.</p> <p>Disconnect the USB charging cable.</p> <p>On your mobile device:</p> <p>Disable the <i>Bluetooth</i> feature and then re-enable.</p> <p>Delete your Bose QuietComfort 45 headphones from the <i>Bluetooth</i> list on your device, including any duplicate listings labeled LE (Low Energy). Connect again.</p> <p>Move your mobile device closer to the headphones and away from any interference or obstructions.</p> <p>Visit support.bose.com/QCSE to see how-to videos.</p> <p>Clear the connected devices list (see page 26) and connect again.</p>
Battery won't charge	<p>Secure the ends of the USB charging cable.</p> <p>Try another charging source.</p> <p>If your headphones have been exposed to high or low temperatures, let the headphones return to room temperature and try charging again.</p>

SYMPTOM	SOLUTION
No sound	<p>Power on the headphones and charge the battery.</p> <p>Check the state of the status light (see page 29).</p> <p>Slide the <i>Power/Bluetooth</i> switch to the right and release to hear the connected device. Make sure you are using the correct device.</p> <p>Move your mobile device closer to the headphones and away from any interference or obstructions.</p> <p>Use a different music source.</p> <p>If two mobile devices are connected, pause your other device first.</p> <p>If two mobile devices are connected, move the devices within range of the headphones (30 ft or 9 m).</p> <p>Try a locally stored music or video file on your mobile device.</p>
Poor sound quality	<p>Use a different music source.</p> <p>Connect another mobile device (see page 25).</p> <p>Disconnect the second device.</p> <p>Move your mobile device closer to the headphones and away from any interference or obstructions.</p> <p>Try a locally stored music or video file on your mobile device.</p>
No sound from a device connected by the back-up audio cable	<p>Secure the ends of the back-up audio cable.</p> <p>Increase the volume on your headphones, your mobile device and music source.</p> <p>Connect another device (see page 25).</p>
Poor sound quality from a device connected by audio cable	<p>Secure the ends of the back-up audio cable.</p> <p>Connect another device (see page 25).</p>
Action button doesn't change the noise cancelling mode	<p>Make sure your headphones are powered on.</p> <p>Use the Bose Music app to change the noise cancelling mode.</p>

SYMPTOM	SOLUTION
Headphones don't connect to a Bose Smart Soundbar or Speaker	Slide and hold the <i>Power/Bluetooth</i> button until you hear "Ready to connect another device," and the <i>Bluetooth</i> light blinks blue. Make sure that the headphones are within 30 ft (9 m) of your soundbar or speaker.
Headphones don't reconnect to a previously-connected Bose Smart Soundbar or Speaker	Reconnect a previously-connected device (see page 26).
Delayed audio when connected to a Bose Smart Soundbar or Speaker	Download the Bose Music app and run available software updates.

A restore to factory settings can clear all settings and return the headphones to their original out-of-box state. After, the headphones can be configured as if they were being set up for the first time.

Restoring to factory settings is only recommended if you are having issues with the headphones, or you have been instructed to do so by Bose customer service.

RESTORE THE HEADPHONES TO FACTORY SETTINGS

1. Remove the headphones from the *Bluetooth* list on your device.
2. Remove the headphones from your Bose account using the Bose Music app.

NOTE: For more information about how to remove the headphones from your Bose account using the Bose Music app, visit:
support.Bose.com/QCSE

3. Slide the *Power/Bluetooth* switch to the right ⌘ and hold. At the same time, press and hold the Action button for 30 seconds.

The status light blinks white. After 30 seconds, the status light blinks amber to indicate factory settings are being restored (2 to 3 seconds).

4. When the restore is complete, the status light slowly blinks blue. The headphones are now in their original out-of-box state.

Læs og opbevar alle sikkerheds- og brugsinstruktioner.

CE Bose Corporation erklærer hermed, at dette produkt stemmer overens med de væsentlige krav og andre relevante bestemmelser i direktiv 2014/53/EU og alle andre krav i EU-direktiver. Den fulde overensstemmelseserklæring kan findes på: www.Bose.com/compliance

UK CA Dette produkt efterlever alle relevante regler for elektromagnetisk kompatibilitet pr. 2016 og alle andre relevante UK-regler. Den fulde overensstemmelseserklæring kan findes på: www.Bose.com/compliance

Bose Corporation erklærer hermed, at dette produkt stemmer overens med de væsentlige krav i henhold til reglerne for radioudstyr pr. 2017 og alle andre relevante UK-regler. Den fulde overensstemmelseserklæring kan findes på: www.Bose.com/compliance

Vigtige sikkerhedsinstruktioner

Anvend ikke dette apparat i nærheden af vand.

Rengør kun med en tør klud.

Overlad al service til kvalificeret servicepersonale. Et serviceeftersyn er påkrævet, når apparatet på nogen måde er beskadiget, hvis f.eks. netledningen eller stikket er beskadiget, der er blevet spildt væske, eller der er kommet genstande ind i apparatet, hvis apparatet er blevet udsat for regn eller fugt, ikke virker normalt eller er blevet tabt.

ADVARSLER/FORSIGTIGHEDSFORHOLDSREGLER

- Brug IKKE hovedtelefonerne ved høj lydstyrke igennem længere tid.
 - For at undgå høreskader skal du bruge hovedtelefonerne med et behageligt, moderat lydstyrkeniveau.
 - Skru ned for lyden på din enhed, inden du placerer hovedtelefonerne i/på dine ører, skru derefter gradvist op for lyden, indtil du når et behageligt lytteniveau.
- Brug IKKE dine hovedtelefoner, mens du kører bil til telefonopkald eller et andet formål.
- Brug IKKE in-ear hovedtelefonerne med støjreduktionstilstanden, da den manglende evne til at høre omgivende lyde kan udgøre en fare for dig selv eller andre, f.eks. når du kører på cykel eller bevæger dig i nærheden af trafik, en byggeplads eller jernbanen osv., og følg gældende lovgivning vedrørende brug af hovedtelefoner.
 - Sluk hovedtelefonerne, eller brug hovedtelefoner med støjreduktion slukket, og tilpas lydstyrken for at sikre, at du kan høre omgivende lyde, herunder alarmer og advarselssignaler.
 - Vær opmærksom på, at lyde, som du stoler på som påmindelser eller advarsler, kan variere i karakter, når du bruger hovedtelefoner, selv ved brug af Opmærksom tilstand.
- Brug IKKE hovedtelefonerne, hvis de udsender høj, unormal støj. Hvis det sker, skal du slukke hovedtelefonerne og kontakte Boses kundeservice.
- Fjern hovedtelefonerne med det samme, hvis du føler varme, eller hvis lyden forsvinder.
- Brug IKKE mobiltelefonadapters til at tilslutte hovedtelefoner til flysædestik, da dette kan medføre personsikkerheds eller tingsskader som følge af overophedning.
- Brug IKKE hovedtelefonerne til luftfartskommunikation.



Indeholder små dele, som kan udgøre en kvælningssfare. Egner sig ikke til børn under 3 år.



Dette produkt indeholder magnetisk materiale. Kontakt din læge for at finde ud af, om dette kan påvirke din implanterbare medicinske enheds funktion.

- For at reducere risikoen for brand eller elektrisk stød, må du IKKE udsætte dette produkt for regn, dryp, sprøjt eller fugt, og du må ikke placere væskefyldte genstande som f.eks. vaser på eller i nærheden af produktet.
- Hold altid produktet væk fra ild og andre varmekilder. Placer IKKE nogen form for åben ild (f.eks. stearinlys) på eller tæt ved produktet.
- Brug kun dette produkt med en godkendt LPS-strømforsyning, der overholder de lokale love og regler (f.eks. UL, CSA, VDE, CCC).
- Foretag IKKE nogen uautoriserede ændringer af produktet.
- Hvis batterierne lækker, må væsken ikke komme i kontakt med huden eller øjnene. Hvis der finder kontakt sted, skal der søges læge.
- Udsæt ikke produkter, der indeholder batterier, for voldsom varme (f.eks. ved opbevaring i direkte sollys, brand eller lignende).
- Må IKKE bæres under opladning.

BEMÆRK: Dette udstyr er testet og det er blevet konstateret, at det overholder grænseværdierne for en digital enhed i Klasse B i henhold til afsnit 15 i FCC-reglerne. Disse grænser er udviklet til at yde rimelig beskyttelse mod skadelig interferens i en privat installation. Dette udstyr genererer, bruger og kan udstråle radiofrekvensenergi, og kan – hvis det ikke installeres og bruges i overensstemmelse med instruktionerne – forårsage skadelig interferens i forbindelse med radiokommunikation. Dette garanterer dog ikke, at der ikke kan forekomme interferens i en bestemt installation. Hvis dette udstyr forårsager skadelig interferens i forbindelse med radio- og tv-modtagelsen, hvilket kan kontrolleres ved at slukke og tænde for udstyret, opfordres brugere til at forsøge at eliminere interferensen ved hjælp af en eller flere af følgende fremgangsmåder:

- Ret det modtagende produkt eller antennen i en anden retning, eller flyt dem.
- Skab større afstand mellem udstyret og modtageren.
- Tilslut udstyret til en stikkontakt på et andet kredsløb end det, som modtageren er tilsluttet.
- Kontakt forhandleren eller en radio/tv-tekniker for at få hjælp.

Ændringer eller modifikationer, der ikke udtrykkeligt er godkendt af Bose Corporation, kan ophæve brugerens ret til at betjene dette udstyr.

Denne enhed overholder del 15 i FCC-reglerne og ISED Canadas licensfritagede RSS-standard(er). Driften er underlagt følgende to betingelser: (1) Denne enhed må ikke forårsage skadelig interferens, og (2) denne enhed skal acceptere enhver modtaget interferens, herunder interferens, der kan forårsage uønsket drift.

Denne enhed overholder FCC's og ISED Canadas strålingseksponeringsgrænser for befolkningen i almindelighed. Denne sender må ikke placeres eller anvendes sammen med nogen andre antenner eller sendere.

Overholder IMDA-kravene.

FCC ID: A94437310

IC: 3232A-437310

CAN ICES-3(B)/NMB-3(B)

Europa:

Frekvensbåndets driftsområde er 2400 til 2483,5 MHz.

Maksimal sendeeffekt mindre end 20 dBm EIRP.

Den maksimale sendeeffekt er under de grænser, reglerne fastsætter. SAR-test er derfor ikke nødvendigt og er undtaget i henhold til de gældende regler.



Dette symbol betyder, at produktet ikke må smides ud som husholdningsaffald og bør indleveres til en passende indsamlingsordning med henblik på genanvendelse. Korrekt bortskaffelse og genanvendelse bidrager til at beskytte naturressourcer, menneskets sundhed og miljøet. Hvis du ønsker flere oplysninger om bortskaffelse og genanvendelse af dette produkt, kan du kontakte din kommune, dit renovationselskab eller den butik, hvor du har købt dette produkt.

Tekniske regler for laveffektradiofrekvensenheder

Ingen virksomhed, organisation eller bruger må uden tilladelse fra NCC ændre frekvensen, øge transmissionseffekten eller ændre de oprindelige egenskaber eller ydelsen for godkendte laveffektradiofrekvensenheder.

Laveffektradiofrekvensenhederne må ikke påvirke flysikkerheden eller forstyrre lovlig kommunikation; hvis dette konstateres, skal brugeren øjeblikkeligt ophøre med at bruge enheden, indtil der opnås en tilstand uden forstyrrelser. Den omtalte lovlige kommunikation vil sige radiokommunikation, der anvendes i overensstemmelse med Telecommunications Management Act. Laveffektradiofrekvensenhederne skal kunne modtage forstyrrelser fra lovlig kommunikation eller enheder, der udsender ISM-radiobølger.

UNDLAD forsøg på at fjerne det genopladelige litium-ion batteri fra dette produkt. Kontakt din lokale Bose-forhandler eller en anden kvalificeret tekniker vedrørende fjernelse.

Fjernelse af det genopladelige litium-ion-batteri i dette produkt skal udføres af en kvalificeret person. Kontakt din lokale Bose-forhandler, eller se products.bose.com/static/compliance/index.html for at få flere oplysninger.



Bortskaf brugte batterier i henhold til lokale bestemmelser. Batterier må ikke brændes.



Navne på og indhold af giftige eller farlige stoffer eller elementer						
Delens navn	Giftige eller farlige stoffer og elementer					
	Bly (Pb)	Kviksølv (Hg)	Cadmium (Cd)	Hexavalent (CR(VI))	Polybromeret biphenyl (PBB)	Polybromeret diphenylether (PBDE)
PCB'er	X	0	0	0	0	0
Metaldele	X	0	0	0	0	0
Plastikdele	0	0	0	0	0	0
Højtaler	X	0	0	0	0	0
Kabler	X	0	0	0	0	0
Denne tabel er oprettet i henhold til bestemmelserne i SJ/T 11364.						
O: Angiver, at dette giftige eller farlige stof indeholdt i alle de homogene materialer til denne del er under grænsekravet i GB/T 26572.						
X: Angiver, at dette giftige eller skadelige stof, som findes i mindst ét af de homogene materialer, der anvendes til denne del, er over grænsekravet i GB/T 26572.						

Fremstillingsdato: Det ottende ciffer i serienummeret angiver fremstillingsåret: "2" er 2012 eller 2022.

Importør i Kina: Bose Electronics (Shanghai) Company Limited, Level 6, Tower D, No. 2337 Gudai Rd. Minhang District, Shanghai 201100

Importør i EU: Bose Products B.V., Gorslaan 60, 1441 RG Purmerend, Holland

Importør i Mexico: Bose de México S. de R.L. de C.V., Avenida Prado Sur #150, Piso 2, Interior 222 y 223, Colonia Lomas de Chapultepec V Sección, Miguel Hidalgo, Ciudad de México, C.P. 11000 Telefonnummer: +5255 (5202) 3545

Importør i Taiwan: Bose Limited Taiwan Branch (H.K.), 9F., No. 10, Sec. 3, Minsheng E. Road, Zhongshan Dist. Taipei City 10480, Taiwan Telefonnummer: +886-2-2514 7676

Importør i UK: Bose Limited, Bose House, Quayside Chatham Maritime, Chatham, Kent, ME4 4QZ, Storbritannien

Inputklassifikation: 5 V --- 0,5 A

Temperaturområde for opladning: 0° C til 45° C

Temperaturområde for afladning: -20° C til 60° C

Model 437310. CMIIT ID kan findes inde i ørekoppen under stoffet.

Bedes udfyldt og opbevaret, så du har det til rådighed

Serie- og modelnumrene er placeret inde i ørekoppen under stoffet.

Serienummer: _____

Modelnummer: _____

Opbevar kvitteringen sammen med brugervejledningen. Dette er et godt tidspunkt til at registrere dit Bose-produkt. Du kan nemt gøre det ved at gå til worldwide.bose.com/ProductRegistration

Sikkerhedsoplysninger



Dette produkt er i stand til at modtage sikkerhedsopdateringer fra Bose automatisk, når det er tilsluttet Bose Music-appen. For at kunne modtage sikkerhedsopdateringer via mobilappen skal du gennemføre produktopsætningsprocessen i Bose Music-appen. **Hvis du ikke gennemfører opsætningsprocessen, har du ansvaret for at installere sikkerhedsopdateringer, som Bose stiller til rådighed via btu.bose.com**

Apple, Apple-logoet, iPad, iPhone og iPod er varemærker, der tilhører Apple Inc., og er registreret i USA og andre lande. App Store er et servicemærke, der tilhører Apple Inc. Varemærket "iPhone" benyttes i Japan med licens fra Aiphone K.K.

Anvendelse af mærket Made for Apple betyder, at et tilbehør er designet til at tilsluttes specifikt til de(t) Apple-produkt(er), som identificeres i mærket, og at det er certificeret af udvikleren til at leve op til Apples ydelsesstandarder. Apple er ikke ansvarlig for denne enheds virkemåde eller for dens overensstemmelse med sikkerhedsstandarder og regler.

Bluetooth[®]-ordmærket og -logoerne er registrerede varemærker, der ejes af Bluetooth SIG, Inc., og enhver brug af sådanne mærker fra Bose Corporations side finder sted under licens.

Google Play er et varemærke, der tilhører Google LLC.

USB Type-C[®] og USB-C[®] er registrerede varemærker, der tilhører USB Implementers Forum.

Bose, Bose Home Speaker, Bose Music, Bose Music-logoet, Bose Smart Soundbar, Bose Smart Speaker, Bose Soundbar, QuietComfort og SimpleSync er varemærker tilhørende Bose Corporation.

Bose Corporations hovedkvarter: 1-877-230-5639

©2022 Bose Corporation. Gengivelse, ændring, distribution eller anden brug af dette dokument eller dele heraf er forbudt uden forudgående skriftlig tilladelse.

The following license disclosures apply to certain third-party software packages used as components in the product.

Package: FreeRTOS

Copyright © Amazon Web Services, Inc. or its affiliates. All rights reserved.

The FreeRTOS package is subject to the license terms reprinted below:

MIT License

Permission is hereby granted, free of charge, to any person obtaining a copy of this software and associated documentation files (the “Software”), to deal in the Software without restriction, including without limitation the rights to use, copy, modify, merge, publish, distribute, sublicense, and/or sell copies of the Software, and to permit persons to whom the Software is furnished to do so, subject to the following conditions:

The above copyright notice and this permission notice shall be included in all copies or substantial portions of the Software.

THE SOFTWARE IS PROVIDED “AS IS”, WITHOUT WARRANTY OF ANY KIND, EXPRESS OR IMPLIED, INCLUDING BUT NOT LIMITED TO THE WARRANTIES OF MERCHANTABILITY, FITNESS FOR A PARTICULAR PURPOSE AND NONINFRINGEMENT. IN NO EVENT SHALL THE AUTHORS OR COPYRIGHT HOLDERS BE LIABLE FOR ANY CLAIM, DAMAGES OR OTHER LIABILITY, WHETHER IN AN ACTION OF CONTRACT, TORT OR OTHERWISE, ARISING FROM, OUT OF OR IN CONNECTION WITH THE SOFTWARE OR THE USE OR OTHER DEALINGS IN THE SOFTWARE.

Package: Nanopb

Copyright © 2011 Petteri Aimonen <jpa at nanopb.mail.kapsi.fi>.

The Nanopb package is subject to the license terms reprinted below:

Zlib License

© 2011 Petteri Aimonen <jpa at nanopb.mail.kapsi.fi>

This software is provided ‘as-is’, without any express or implied warranty. In no event will the authors be held liable for any damages arising from the use of this software.

Permission is granted to anyone to use this software for any purpose, including commercial applications, and to alter it and redistribute it freely, subject to the following restrictions:

1. The origin of this software must not be misrepresented; you must not claim that you wrote the original software. If you use this software in a product, an acknowledgment in the product documentation would be appreciated but is not required.
2. Altered source versions must be plainly marked as such, and must not be misrepresented as being the original software.
3. This notice may not be removed or altered from any source distribution.

Package: Mbed TLS 2.16.1

© ARM Limited. All rights reserved.

The Mbed TLS package is subject to the license terms reprinted below:

Apache License

Version 2.0, January 2004

<http://www.apache.org/licenses/>

TERMS AND CONDITIONS FOR USE, REPRODUCTION, AND DISTRIBUTION

1. Definitions.
“License” shall mean the terms and conditions for use, reproduction, and distribution as defined by Sections 1 through 9 of this document.

“Licensor” shall mean the copyright owner or entity authorized by the copyright owner that is granting the License.

“Legal Entity” shall mean the union of the acting entity and all other entities that control, are controlled by, or are under common control with that entity. For the purposes of this definition, “control” means (i) the power, direct or indirect, to cause the direction or management of such entity, whether by contract or otherwise, or (ii) ownership of fifty percent (50%) or more of the outstanding shares, or (iii) beneficial ownership of such entity.

“You” (or “Your”) shall mean an individual or Legal Entity exercising permissions granted by this License.

“Source” form shall mean the preferred form for making modifications, including but not limited to software source code, documentation source, and configuration files.

“Object” form shall mean any form resulting from mechanical transformation or translation of a Source form, including but not limited to compiled object code, generated documentation, and conversions to other media types.

“Work” shall mean the work of authorship, whether in Source or Object form, made available under the License, as indicated by a copyright notice that is included in or attached to the work (an example is provided in the Appendix below).

“Derivative Works” shall mean any work, whether in Source or Object form, that is based on (or derived from) the Work and for which the editorial revisions, annotations, elaborations, or other modifications represent, as a whole, an original work of authorship. For the purposes of this License, Derivative Works shall not include works that remain separable from, or merely link (or bind by name) to the interfaces of, the Work and Derivative Works thereof.

“Contribution” shall mean any work of authorship, including the original version of the Work and any modifications or additions to that Work or Derivative Works thereof, that is intentionally submitted to Licensor for inclusion in the Work by the copyright owner or by an individual or Legal Entity authorized to submit on behalf of the copyright owner. For the purposes of this definition, “submitted” means any form of electronic, verbal, or written communication sent to the Licensor or its representatives, including but not limited to communication on electronic mailing lists, source code control systems, and issue tracking systems that are managed by, or on behalf of, the Licensor for the purpose of discussing and improving the Work, but excluding communication that is conspicuously marked or otherwise designated in writing by the copyright owner as “Not a Contribution.”

“Contributor” shall mean Licensor and any individual or Legal Entity on behalf of whom a Contribution has been received by Licensor and subsequently incorporated within the Work.

2. Grant of Copyright License. Subject to the terms and conditions of this License, each Contributor hereby grants to You a perpetual, worldwide, non-exclusive, no-charge, royalty-free, irrevocable copyright license to reproduce, prepare Derivative Works of, publicly display, publicly perform, sublicense, and distribute the Work and such Derivative Works in Source or Object form.
3. Grant of Patent License. Subject to the terms and conditions of this License, each Contributor hereby grants to You a perpetual, worldwide, non-exclusive, no-charge, royalty-free, irrevocable (except as stated in this section) patent license to make, have made, use, offer to sell, sell, import, and otherwise transfer the Work, where such license applies only to those patent claims licensable by such Contributor that are necessarily infringed by their Contribution(s) alone or by combination of their Contribution(s) with the Work to which such Contribution(s) was submitted. If You institute patent litigation against any entity (including a cross-claim or counterclaim in a lawsuit) alleging that the Work or a Contribution incorporated within the Work constitutes direct or contributory patent infringement, then any patent licenses granted to You under this License for that Work shall terminate as of the date such litigation is filed.
4. Redistribution. You may reproduce and distribute copies of the Work or Derivative Works thereof in any medium, with or without modifications, and in Source or Object form, provided that You meet the following conditions:
 - a. You must give any other recipients of the Work or Derivative Works a copy of this License; and
 - b. You must cause any modified files to carry prominent notices stating that You changed the files; and
 - c. You must retain, in the Source form of any Derivative Works that You distribute, all copyright, patent, trademark, and attribution notices from the Source form of the Work, excluding those notices that do not pertain to any part of the Derivative Works; and

d. If the Work includes a “NOTICE” text file as part of its distribution, then any Derivative Works that You distribute must include a readable copy of the attribution notices contained within such NOTICE file, excluding those notices that do not pertain to any part of the Derivative Works, in at least one of the following places: within a NOTICE text file distributed as part of the Derivative Works; within the Source form or documentation, if provided along with the Derivative Works; or, within a display generated by the Derivative Works, if and wherever such third-party notices normally appear. The contents of the NOTICE file are for informational purposes only and do not modify the License. You may add Your own attribution notices within Derivative Works that You distribute, alongside or as an addendum to the NOTICE text from the Work, provided that such additional attribution notices cannot be construed as modifying the License.

You may add Your own copyright statement to Your modifications and may provide additional or different license terms and conditions for use, reproduction, or distribution of Your modifications, or for any such Derivative Works as a whole, provided Your use, reproduction, and distribution of the Work otherwise complies with the conditions stated in this License.

5. Submission of Contributions. Unless You explicitly state otherwise, any Contribution intentionally submitted for inclusion in the Work by You to the Licensor shall be under the terms and conditions of this License, without any additional terms or conditions. Notwithstanding the above, nothing herein shall supersede or modify the terms of any separate license agreement you may have executed with Licensor regarding such Contributions.
6. Trademarks. This License does not grant permission to use the trade names, trademarks, service marks, or product names of the Licensor, except as required for reasonable and customary use in describing the origin of the Work and reproducing the content of the NOTICE file.
7. Disclaimer of Warranty. Unless required by applicable law or agreed to in writing, Licensor provides the Work (and each Contributor provides its Contributions) on an “AS IS” BASIS, WITHOUT WARRANTIES OR CONDITIONS OF ANY KIND, either express or implied, including, without limitation, any warranties or conditions of TITLE, NON-INFRINGEMENT, MERCHANTABILITY, or FITNESS FOR A PARTICULAR PURPOSE. You are solely responsible for determining the appropriateness of using or redistributing the Work and assume any risks associated with Your exercise of permissions under this License.
8. Limitation of Liability. In no event and under no legal theory, whether in tort (including negligence), contract, or otherwise, unless required by applicable law (such as deliberate and grossly negligent acts) or agreed to in writing, shall any Contributor be liable to You for damages, including any direct, indirect, special, incidental, or consequential damages of any character arising as a result of this License or out of the use or inability to use the Work (including but not limited to damages for loss of goodwill, work stoppage, computer failure or malfunction, or any and all other commercial damages or losses), even if such Contributor has been advised of the possibility of such damages.
9. Accepting Warranty or Additional Liability. While redistributing the Work or Derivative Works thereof, You may choose to offer, and charge a fee for, acceptance of support, warranty, indemnity, or other liability obligations and/or rights consistent with this License. However, in accepting such obligations, You may act only on Your own behalf and on Your sole responsibility, not on behalf of any other Contributor, and only if You agree to indemnify, defend, and hold each Contributor harmless for any liability incurred by, or claims asserted against, such Contributor by reason of your accepting any such warranty or additional liability.

END OF TERMS AND CONDITIONS

©2022 Bose Corporation

Licensed under the Apache License, Version 2.0 (the “License”); you may not use this file except in compliance with the License.

You may obtain a copy of the License at: <http://www.apache.org/licenses/LICENSE-2.0>

Unless required by applicable law or agreed to in writing, software distributed under the License is distributed on an “AS IS” BASIS, WITHOUT WARRANTIES OR CONDITIONS OF ANY KIND, either express or implied.

See the License for the specific language governing permissions and limitations under the License.

HVAD ER DER I ÆSKEN?

Indhold	13
---------------	----

BOSE MUSIC-APPEN

Download Bose Music-appen.....	14
Tilføj hovedtelefonerne til en eksisterende konto	14

HOVEDTELEFONKNAPPER

Tænd	16
Standbytimer.....	16
Sluk.....	17
Hovedtelefonfunktioner	18
Medieafspilning og lydstyrke	18
Telefonopkald.....	19
Handlingsknap	20

STØJREDUKTION

Støjreduktionstilstande.....	21
Skift tilstand for støjreduktion.....	21

STEMMESTYRING

Adgang til stemmestyling.....	22
-------------------------------	----

BLUETOOTH®-FORBINDELSER

Opret forbindelse ved hjælp af <i>Bluetooth</i> -menuen på din mobile enhed	23
Frakobling af en mobil enhed	25
Genopret forbindelse til en mobil enhed.....	25
Tilslut endnu en mobilenhed	25
Identificer tilsluttede mobile enheder	25
Skift mellem to tilsluttede mobile enheder	25
Tilslut en tidligere tilsluttet enhed igen.....	26
Ryd hovedtelefonernes enhedsliste.....	26

KABELBASEREDE FORBINDELSER

Tilslut lydkalet.....	27
-----------------------	----

BATTERI

Oplad hovedtelefonerne	28
Opladningstid.....	28
Hør batteriniveauet.....	28

HOVEDTELEFONSTATUS

<i>Bluetooth</i> -status	29
Batteristatus	29
Opladningsstatus	30
Opdaterings- og fejlstatus	30

TILSLUT PRODUKTER FRA BOSE

Opret forbindelse til en Bose Smart Speaker eller Soundbar	31
Fordele.....	31
Kompatible produkter.....	31
Tilslut ved hjælp af Bose Music-appen.....	31
Genopret forbindelsen til en Bose Smart Speaker eller Soundbar	32

PLEJE OG VEDLIGEHOLDELSE

Opbevar hovedtelefonerne	33
Rengør hovedtelefonerne.....	34
Reserve dele og tilbehør	34
Begrænset garanti.....	34
Serienummerets placering	35

FEJLFINDING

Prøv disse løsninger først 36

Andre løsninger 36

Gendan hovedtelefonernes fabriksindstillinger 39

INDHOLD

Bekræft, at følgende dele er i æsken:



Bose QuietComfort 45-hovedtelefoner

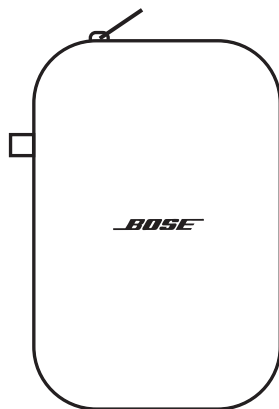

Blødt etui



USB Type-C®-kabel

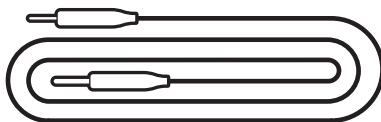

3,5 til 2,5 mm lyd kabel

BEMÆRK: Brug ikke en del af produktet, hvis det er beskadiget. Kontakt din autoriserede Bose-forhandler eller Boses kundeservice.

Besøg: support.bose.com/QCSE

Med Bose Music-appen kan du indstille og kontrollere hovedtelefonerne fra en hvilken som helst mobil enhed som f.eks. en smartphone eller tablet.

Ved hjælp af appen kan du administrere *Bluetooth*-forbindelser, administrere indstillinger for hovedtelefonerne, vælge dit talemiddelssprog og få adgang til nye funktioner via opdateringer.

BEMÆRK: Hvis du allerede har oprettet en Bose Music-konto for et andet Bose-produkt, skal du tilføje hovedtelefonerne til din eksisterende konto (se nederst på side 14).

DOWNLOAD BOSE MUSIC-APPEN

1. Download Bose Music-appen på din mobile enhed.

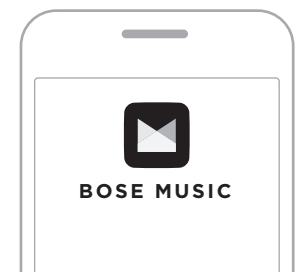

2. Følg app-instruktionerne.

TILFØJ HOVEDTELEFONERNE TIL EN EKSISTERENDE KONTO

Du kan tilføje dine Bose QuietComfort 45-hovedtelefoner ved at åbne Bose Music-appen og tilføje dine hovedtelefoner.

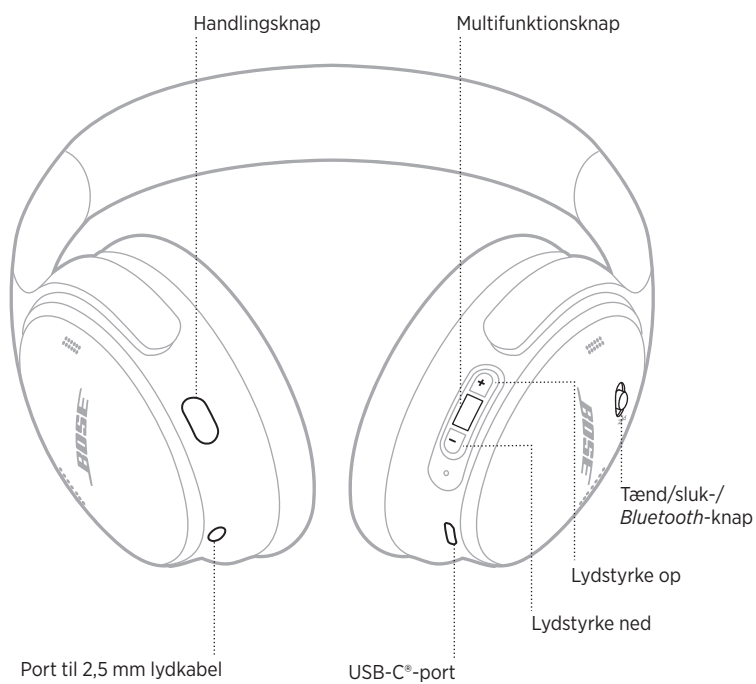

TÆND

På den højre ørekep skal du skubbe tænd/sluk/*Bluetooth*-knappen til højre.

En talemeddelelse giver besked om batteriniveaue, og statuslampen lyser svarende til det aktuelle opladningsniveau (se side 29).



Standbytimer

Standbytimeren sparer på strømmen, når hovedtelefonerne ikke anvendes.

Hvis du vil konfigurere og tilpasse standbytimeren, skal du bruge Bose Music-appen.

SLUK

Skub tænd/sluk/*Bluetooth*-knappen til venstre.



BEMÆRK: Når hovedtelefonerne er slukket, er støjreduktion deaktiveret.

HOVEDTELEFONFUNKTIONER

Hovedtelefonernes knapper findes på bagsiden af den højre ørekop.

Medieafspilning og lydstyrke

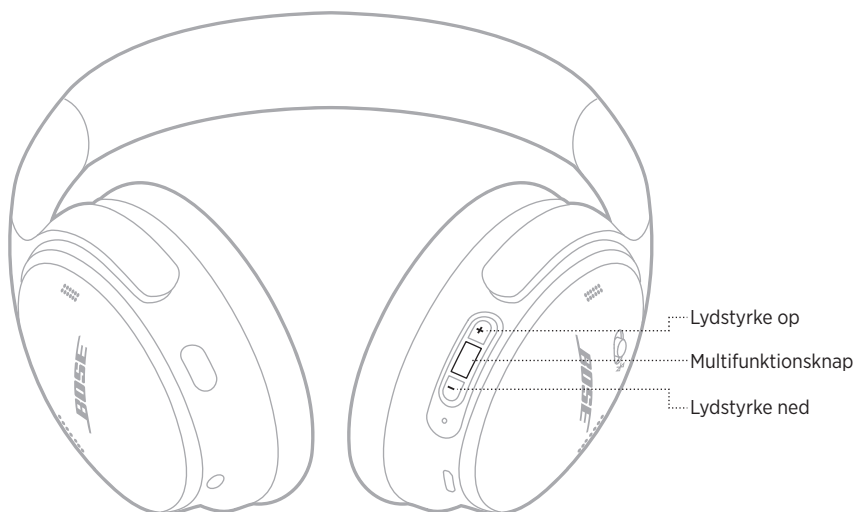

FUNKTION	GØR FØLGENDE
Afspil/pause	Tryk på multifunktionsknappen.
Gå frem	Dobbeltryk på multifunktionsknappen.
Gå tilbage	Tryk tre gange på multifunktionsknappen.
Lydstyrke op	Tryk på +.
Lydstyrke ned	Tryk på -.

BEMÆRKNINGER:

- Du kan hurtigt øge lydstyrken ved at trykke på + og holde knappen nede.
- Du kan hurtigt reducere lydstyrken ved at trykke på - og holde knappen nede.

Telefonopkald

Multifunktionsknappen er placeret på bagsiden af den højre ørekop. Mikrofonen er placeret ved forsiden af den højre ørekop.

Handlingsknappen er placeret på bagsiden af den venstre ørekop.

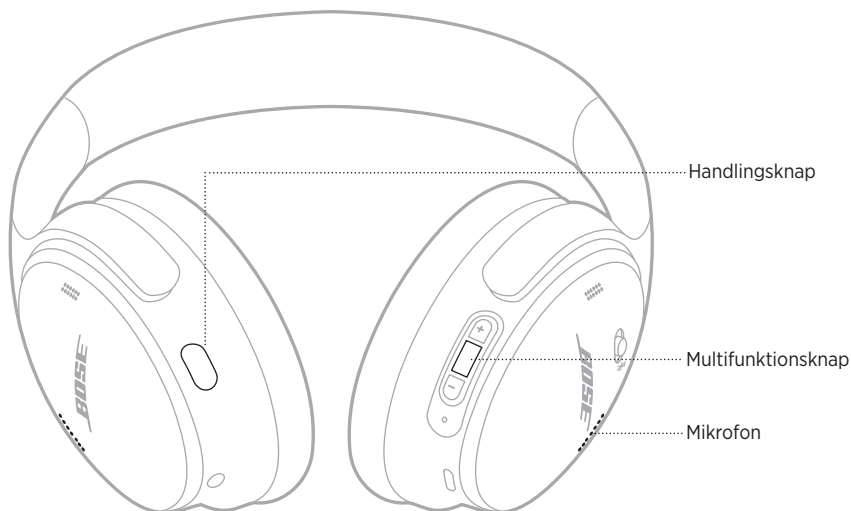

FUNKTION	GØR FØLGENDE
Besvar/afslut et opkald	Tryk på multifunktionsknappen.
Afvis et indgående opkald	Tryk på multifunktionsknappen, og hold den nede i 1 sekund.
Besvar et andet indgående opkald, og parker det aktuelle opkald	Hvis der kommer et nyt indgående opkald under et opkald, skal du trykke på multifunktionsknappen.
Afvis et nyt opkald, og bliv i det aktuelle opkald	Hvis der kommer et nyt indgående opkald under et opkald, skal du trykke på multifunktionsknappen og holde den nede i 1 sekund.
Skift mellem to opkald	Mens to opkald er aktive, skal du trykke to gange på multifunktionsknappen.
Opret en konference	Mens de to opkald er aktive, skal du trykke på multifunktionsknappen og holde den nede i 3 sekunder.
Slå lyden til/fra for et opkald	Under et opkald skal du trykke to gange på handlingsknappen.

Handlingsknap

Handlingsknappen giver dig mulighed for hurtigt og nemt at skifte mellem støjreduktionstilstande.

Handlingsknappen er placeret på bagsiden af den venstre ørekop.



Hvis du vil skifte mellem tilstanden Stille og tilstanden Opmærksom, skal du trykke på handlingsknappen.

Du kan finde flere oplysninger om støjreduktionstilstande på side 21.

Støjreduktion reducerer uønsket støj og giver en mere klar og virkelighedstro lydoplevelse. Du kan vælge mellem to støjreduktionstilstande: Stille og Opmærksom.

Tilstanden Stille giver dig mulighed for at udelukke distraktioner ved at bruge støjreduktion på det højeste niveau.

Tilstanden Opmærksom giver fuld transparens, så du kan høre dine omgivelser, mens du nyder din lyd.

Du kan vælge din støjreduktionstilstand baseret på dine lyttepræferencer og omgivelserne.

STØJREDUKTIONSTILSTANDE

TILSTAND	BESKRIVELSE
Stille	Støjreduktion i verdensklasse med optimeret Bose-lyd.
Opmærksom	Hør dine omgivelser, mens du nyder din lyd.

BEMÆRK: Når dette er slået til, anvender hovedtelefonerne som standard den tilstand, du senest har brugt.

SKIFT TILSTAND FOR STØJREDUKTION

Hvis du vil ændre støjreduktionstilstanden, skal du trykke på handlingsknappen.

En talemæssig besked giver besked om den valgte støjreduktionstilstand.

TIP: Du kan også ændre støjreduktionstilstanden ved hjælp af Bose Music-appen.

ADGANG TIL STEMMESTYRING

Du kan bruge hovedtelefonerne til at få adgang til stemmestyring på din mobile enhed. For at få adgang til stemmestyring skal du trykke på multifunktionsknappen og holde den nede i 1 sekund.

Multifunktionsknappen er placeret på bagsiden af den højre ørekop.

BEMÆRK: Du kan ikke få adgang til stemmestyring, mens du er i gang med en samtale.

OPRET FORBINDELSE VED HJÆLP AF *BLUETOOTH*-MENUEN PÅ DIN MOBILE ENHED

Du kan gemme op til otte enheder på hovedtelefonernes enhedsliste, og hovedtelefonerne kan aktivt forbindes til to enheder ad gangen. Du kan kun afspille lyd på en mobil enhed ad gangen.

BEMÆRK: For at få den bedste oplevelse skal du bruge Bose Music-appen til at konfigurere og tilslutte din mobile enhed (se side 14).

1. Skub tænd/sluk/*Bluetooth*-kontakten til højre , og hold den nede i 3 sekunder.

Du hører "Klar til at oprette forbindelse", og statuslampen blinker blå.



2. Aktivér *Bluetooth*-funktionen på din enhed.

BEMÆRK: *Bluetooth*-funktionen findes normalt i menuen Indstillinger.

3. Vælg dine hovedtelefoner på enhedslisten.

TIP: Led efter det navn, du angav for dine hovedtelefoner, i Bose Music-appen.
Hvis du ikke navngav dine hovedtelefoner, vises standardnavnet.



Når der er oprettet forbindelse, hører du "Sluttet til <navn på enhed>," og statuslampen lyser blåt konstant i 10 sekunder.

FRAKOBLING AF EN MOBIL ENHED

Brug Bose Music-appen til at frakoble din mobile enhed.

TIP: Du kan også bruge *Bluetooth*-indstillinger til at frakoble din enhed. Hvis du deaktiverer *Bluetooth*-funktionen, frakobles alle andre enheder.

GENOPRET FORBINDELSE TIL EN MOBIL ENHED

Når hovedtelefonerne er tændt, vil de forsøge at oprette forbindelse igen til to af de enheder, der har været tilsluttet for nylig.

BEMÆRKNINGER:

- Enheden skal være inden for rækkevidde (9 meter) og tændt.
- Sørg for, at *Bluetooth*-funktionen er aktiveret på din mobile enhed.

TILSLUT ENDNU EN MOBILENHED

Hvis du vil tilslutte en ekstra enhed, skal du downloade Bose Music-appen (se side 14) eller bruge *Bluetooth*-menuen på din mobile enhed (se side 23).

BEMÆRK: Du kan kun afspille lyd fra én enhed ad gangen.

IDENTIFICER TILSLUTTEDE MOBILE ENHEDER

Skub tænd/sluk/*Bluetooth*-kontakten til højre ⌘ og slip den for at høre, hvilken enhed der er tilsluttet i øjeblikket.

SKIFT MELLEM TO TILSLUTTEDE MOBILE ENHEDER

1. Sæt lyden på den første mobile enhed på pause.
2. Afspil lyd på den anden mobile enhed.

BEMÆRK: Dine hovedtelefoner modtager telefonopkald fra begge enheder, uanset hvilken enhed der afspiller lyd.

TILSLUT EN TIDLIGERE TILSLUTTET ENHED IGEN

1. Skub tænd/sluk/*Bluetooth*-knappen til højre ☒ og slip den for at høre, hvilken enhed der er tilsluttet.
2. Inden for 2 sekunder skal du skubbe tænd/sluk/*Bluetooth*-knappen til højre ☒ og slippe den igen for at oprette forbindelse til den næste enhed på hovedtelefonenhedslisten.
3. Gentag, indtil du hører navnet på den korrekte enhed.
Du hører en tone, der angiver, at enheden er tilsluttet.
4. Afspil lyd på den tilsluttede mobile enhed.

BEMÆRK: Hvis der allerede er tilsluttet to enheder til hovedtelefonerne, erstatter den nye tilsluttede enhed den anden enhed, som blev tilsluttet tidligere.

RYD HOVEDTELEFONERNES ENHEDSLISTE

1. Skub tænd/sluk/*Bluetooth*-kontakte mod højre ☒, og hold den i 15 sekunder, indtil du hører "Liste over *Bluetooth*-enheder ryddet. Klar til tilslutning."
2. Slet dine hovedtelefoner fra *Bluetooth*-listen på din mobile enhed.
Alle enheder slettes, og hovedtelefonerne er klar til at blive tilsluttet.

TILSLUT LYDKABLET

Brug det medfølgende 2,5 mm til 3,5 mm-kabel til at forbinde en ikke-trådløs enhed eller til at fortsætte med at bruge hovedtelefonerne, hvis batteriet er afladet.

1. Sæt kablet i 2,5 mm-porten på den venstre ørekop.



2. Sæt den anden ende af kablet i 3,5 mm-porten på din enhed.

BEMÆRK: Du kan bruge hovedtelefonerne i tændt eller slukket tilstand, når lyd-kablet er tilsluttet.

OPLAD HOVEDTELEFONERNE

1. Sæt den lille ende af USB-kablet i USB-C-porten på den højre ørekop.
2. Tilslut den anden ende til en USB-vægoplader.



BEMÆRKNINGER:

- Når hovedtelefonerne begynder at oplade, blinker statuslampen hvidt i 10 sekunder. Når de er fuldt opladede, lyser statuslampen hvidt konstant.
- Hovedtelefonerne afspiller ikke under opladning.

Opladningstid

Bemærk, at en fuld opladning af hovedtelefonerne tager op til 2,5 timer.

Hør batteriniveaut

Hver gang du tænder hovedtelefonerne, høres der en talemeddelelse, som angiver batteriniveaut. Hvis hovedtelefonernes batteriniveau er lavt, hører du "Lav batteriladning, oplad nu."

BEMÆRK: Du kan kontrollere batteriet visuelt ved hjælp af statuslampen på den højre ørekop. Du finder flere oplysninger under "Batteristatus" på side 29.

Statuslampen er placeret på den højre ørekop.



BLUETOOTH-STATUS

Viser status for *Bluetooth*-forbindelsen.

LYSAKTIVITET	SYSTEMTILSTAND
Blinker blå	Klar til tilslutning
Lyser konstant blå (10 sekunder)	Tilsluttet

BATTERISTATUS

Viser batteriniveauet.

LYSAKTIVITET	SYSTEMTILSTAND
Lyser hvidt	Medium til fuld opladning
Lyser gult	Lav opladning

TIP: Du kan også kontrollere batteriniveauet ved hjælp af Bose Music-appen.

OPLADNINGSSTATUS

Viser opladningsstatus.

LYSAKTIVITET	SYSTEMTILSTAND
Blinker hvidt 2 gange	Opladningen starter
Lyser gult	Oplader
Lyser hvidt	Fuldt opladet

OPDATERINGS- OG FEJLSTATUS

Viser opdaterings- eller fejlstatus.

LYSAKTIVITET	SYSTEMTILSTAND
Blinker hurtigt hvidt (10 sekunder)	Opdaterer software (via USB)
Blinker langsomt hvidt (30 til 60 sekunder)	Opdaterer software (trådløst)
Blinker gult og hvidt	Fejl. Kontakt Bose kundeservice

OPRET FORBINDELSE TIL EN BOSE SMART SPEAKER ELLER SOUNDBAR

Med SimpleSync™-teknologi kan du tilslutte hovedtelefonerne til en Bose Smart Soundbar eller en Bose Smart Speaker og få en personlig lytteoplevelse.

Fordele

- Brug den uafhængige lydstyrkeregulering på hvert produkt til at reducere lyden eller slå den helt fra på din Bose Smart Soundbar, mens du kan have lyden lige så høj, som du vil, i hovedtelefonerne.
- Hør musik tydeligt fra et andet rum ved at tilslutte hovedtelefonerne til din Bose Smart Speaker.

BEMÆRK: SimpleSync™-teknologien har en *Bluetooth*-rækkevidde på op til 9 meter. Vægge og byggematerialer kan påvirke modtagelsen.

Kompatible produkter

Du kan tilslutte hovedtelefonerne til enhver Bose Smart Speaker eller Bose Smart Soundbar.

Populære compatible produkter omfatter:

- Bose Smart Soundbar 700/Bose Soundbar 700
- Bose Soundbar 500
- Bose Smart Speaker 500/Bose Home Speaker 500
- Bose Home Speaker 300
- Bose Portable Smart Speaker/Bose Portable Home Speaker

Nye produkter tilføjes jævnligt. Du kan finde en komplet liste og flere oplysninger her: worldwide.Bose.com/Support/Groups

Tilslut ved hjælp af Bose Music-appen

1. På hovedtelefonerne skal du skubbe tænd/sluk/*Bluetooth*-kontakten til højre ⌘ og holde den nede i 3 sekunder.

Du hører ”Klar til at oprette forbindelse til en anden enhed”, og statuslampen blinker blå.
2. Brug Bose Music-appen til at tilslutte hovedtelefonerne til et kompatibelt Bose-produkt. Du kan finde flere oplysninger her: worldwide.Bose.com/Support/Groups

BEMÆRKNINGER:

- Sørg for, at hovedtelefonerne er inden for 9 m fra din soundbar eller din højttaler.
- Du kan kun tilslutte hovedtelefonerne til et produkt ad gangen.

GENOPRET FORBINDELSEN TIL EN BOSE SMART SPEAKER ELLER SOUNDBAR

Tænd hovedtelefonerne (se “Tænd” på side 16).

Hovedtelefonerne forsøger at oprette forbindelse til de to senest tilsluttede *Bluetooth*-enheder, herunder din soundbar eller din højtaler.

BEMÆRKNINGER:

- Din soundbar eller din højtaler skal være inden for rækkevidde (9 meter) og tændt.
- Hvis hovedtelefonerne ikke opretter forbindelse igen, skal du læse “Hovedtelefonerne genopretter ikke forbindelsen til en tidligere tilsluttet Bose Smart Soundbar eller Speaker” på side 38.

OPBEVAR HOVEDTELEFONERNE

Ørekopperne roteres, så de nemt kan opbevares på minimal plads. Placer hovedtelefonerne fladt i etuiet.

1. Drej begge ørekopper, så de ligger fladt.



2. Fold den venstre ørekep mod hovedbåndet.

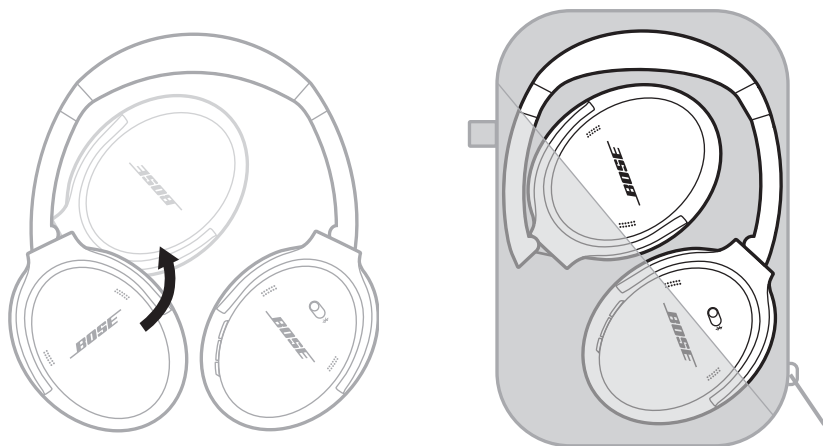

BEMÆRKNINGER:

- Sørg for at slukke hovedtelefonerne, når de ikke er i brug.
- Inden du opbevarer hovedtelefonerne i mere end et par måneder, skal du sørge for, at batteriet er fuldt opladet.

RENGØR HOVEDTELEFONERNE

Tør de ydre overflader med en blød, tør klud.

Der må ikke komme fugt ind i ørekopperne.

RESERVEDELE OG TILBEHØR

Reserve dele og tilbehør kan bestilles via Boses kundeservice.

Besøg: support.bose.com/QCSE

BEGRÆNSET GARANTI

Dine hovedtelefoner er omfattet af en begrænset garanti. Se vores websted på worldwide.bose.com/Warranty for at få flere oplysninger om den begrænsede garanti.

Hvis du vil registrere dit produkt, kan du finde instruktioner på worldwide.bose.com/ProductRegistration. Hvis du undlader at registrere produktet, har det ingen betydning for den begrænsede garanti.

SERIENUMMERETS PLACERING

Serienummeret er placeret inde i den højre ørekop under stoffet. Stofbeklædningen er den indre afskærmning, som dækker og beskytter komponenterne inde i ørekoppen.

Hvis du vil se serienummeret, skal du tage fat i stofbeklædningen ved den øverste kant og forsigtigt trække den væk.

FORSIGTIG: Pas på ikke at trykke på eller fjerne nogen andre komponenter inde i ørekoppen, da dette kan beskadige hovedtelefonerne.

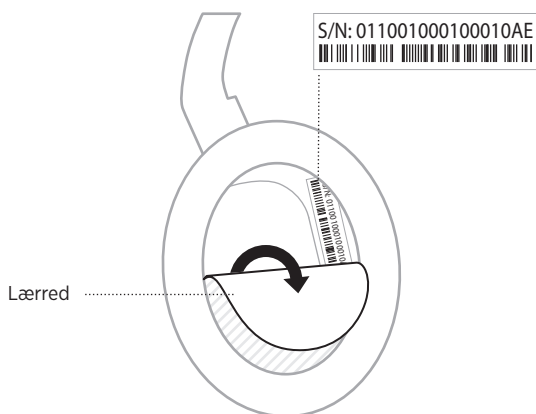

PRØV DISSE LØSNINGER FØRST

Hvis du oplever problemer med dine hovedtelefoner:

- Tjek tilstand for statuslamperne (se side 29).
- Oplad batteriet (se side 28).
- Øg lydstyrken på dine hovedtelefoner, på din mobile enhed og i musikappen.
- Download Bose Music-appen, og køør tilgængelige softwareopdateringer (se side 14).
- Prøv at oprette forbindelse til en anden mobil enhed (se side 25).

Hvis dette ikke løser problemet, kan du i nedenstående tabel identificere symptomer og løsninger på almindelige problemer. Kontakt Bose kundeservice, hvis du ikke kan løse dit problem.

Besøg: worldwide.Bose.com/contact

ANDRE LØSNINGER

SYMPTOM	LØSNING
Hovedtelefonerne tændes ikke	Oplad batteriet.
Hovedtelefonerne kan ikke tilsluttes til en mobil enhed	<p>Frakobl backuplydkablet.</p> <p>Frakobl USB-opladningskablet.</p> <p>På din mobile enhed:</p> <p>Deaktiver <i>Bluetooth</i>-funktionen, og slå den derefter til igen.</p> <p>Slet dine Bose QuietComfort 45-hovedtelefoner fra din enheds <i>Bluetooth</i>-liste, herunder eventuelle dubletposter med angivelsen LE (Low Energy). Tilslut igen.</p> <p>Flyt din mobile enhed tættere på hovedtelefonerne og væk fra eventuel interferens eller forhindringer.</p> <p>Gå til support.Bose.com/QCSE for at se Sådan gør du-videoer.</p> <p>Ryd listen med tilsluttede enheder (se side 26), og tilslut igen.</p>
Batteriet oplades ikke	<p>Fastgør USB-opladningskablets ender.</p> <p>Prøv en anden opladningskilde.</p> <p>Hvis dine hovedtelefoner har været udsat for høje eller lave temperaturer, skal du lade hovedtelefonerne vende tilbage til stuetemperatur og forsøge at oplade igen.</p>

SYMPTOM	LØSNING
Ingen lyd	<p>Tænd hovedtelefonerne, og oplad batteriet.</p> <p>Tjek tilstand for statuslamperne (se side 29).</p> <p>Skub tænd/sluk/<i>Bluetooth</i>-kontakten til højre og slip den for at høre den tilsluttede enhed. Kontrollér, at du bruger den rigtige enhed.</p> <p>Flyt din mobile enhed tættere på hovedtelefonerne og væk fra eventuel interferens eller forhindringer.</p> <p>Prøv en anden musikkilde.</p> <p>Hvis to enheder er tilslutte, skal du standse din anden mobile enhed først.</p> <p>Hvis der er tilsluttet to enheder, skal du flytte de mobile enheder inden for hovedtelefonernes rækkevidde (9 m).</p> <p>Prøv en musik- eller videofil, der er gemt lokalt på din mobile enhed.</p>
Dårlig lyd kvalitet	<p>Prøv en anden musikkilde.</p> <p>Tilslut en ekstra mobil enhed (se side 25).</p> <p>Frakobl den anden enhed.</p> <p>Flyt din mobile enhed tættere på hovedtelefonerne og væk fra eventuel interferens eller forhindringer.</p> <p>Prøv en musik- eller videofil, der er gemt lokalt på din mobile enhed.</p>
Ingen lyd fra en enhed, der er tilsluttet via backup-lydkablet	<p>Fastgør backuplydkablets ender.</p> <p>Øg lydstyrken på hovedtelefonerne, mobilenheden og musikilden.</p> <p>Tilslut en ekstra enhed (se side 25).</p>
Dårlig lyd fra en enhed, der er tilsluttet med et lyd kabel	<p>Fastgør backuplydkablets ender.</p> <p>Tilslut en ekstra enhed (se side 25).</p>
Handlingsknappen ændrer ikke støjreduktionstilstanden	<p>Kontrollér, at dine hovedtelefoner er tændt.</p> <p>Brug Bose Music-appen til at ændre støjreduktionstilstanden.</p>

SYMPTOM	LØSNING
Hovedtelefonerne opretter ikke forbindelse til en Bose Smart Soundbar eller Speaker	<p>Skub tænd/sluk-/<i>Bluetooth</i>-knappen og hold den nede, indtil du hører "Klar til tilslutning af en anden enhed", og <i>Bluetooth</i>-indikatoren blinker blåt.</p> <p>Sørg for, at hovedtelefonerne er inden for 9 m fra din soundbar eller din højttaler.</p>
Hovedtelefonerne genopretter ikke forbindelsen til en tidligere tilsluttet Bose Smart Soundbar eller Speaker	<p>Tilslut en tidligere tilsluttet enhed igen (se side 26).</p>
Forsinket lyd, når der er oprettet forbindelse til en Bose Smart Soundbar eller Speaker	<p>Download Bose Music-appen, og kørs tilgængelige softwareopdateringer.</p>

En gendannelse til fabriksindstillingerne kan rydde alle indstillinger og bringe hovedtelefonerne tilbage til den tilstand, de var i ved leveringen. Derefter kan hovedtelefonerne konfigureres, som om det gøres for første gang.

En gendannelse til fabriksindstillingerne anbefales kun, hvis du har problemer med hovedtelefonerne, eller hvis Boses kundeservice har bedt dig om at gøre det.

GENDAN HOVEDTELEFONERNES FABRIKSINDSTILLINGER

1. Fjern hovedtelefonerne fra *Bluetooth*-listen på din enhed.
2. Fjern hovedtelefonerne fra din Bose-konto ved hjælp af Bose Music-appen.

BEMÆRK: Du kan finde flere oplysninger om, hvordan du fjerner hovedtelefonerne fra din Bose-konto ved hjælp af Bose Music-appen, her: support.bose.com/QCSE

3. Skub tænd/sluk/*Bluetooth*-kontakten til højre ☞, og hold den nede. Tryk og hold samtidig handlingsknappen i 30 sekunder.

Statuslampen blinker hvidt. Efter 30 sekunder blinker statuslampen gult som en angivelse af, at fabriksindstillingerne gendannes (2 til 3 sekunder).

4. Når gendannelsen er gennemført, blinker statuslampen langsomt blå. Hovedtelefonerne er nu i den tilstand, de oprindeligt var i ved leveringen.

Bitte lesen Sie alle Sicherheitshinweise und Gebrauchsanleitungen durch und bewahren Sie sie auf.

CE Die Bose Corporation erklärt hiermit, dass dieses Produkt die wesentlichen Anforderungen und andere relevante Bestimmungen der Richtlinie 2014/53/EU und weitere geltende EU-Richtlinien erfüllt. Die vollständige Konformitätserklärung ist einsehbar unter: www.Bose.com/compliance

UK CA Dieses Produkt erfüllt alle geltenden Vorschriften zur elektromagnetischen Verträglichkeit 2016 und alle anderen zutreffenden UK-Richtlinien. Die vollständige Konformitätserklärung ist einsehbar unter www.Bose.com/compliance

Die Bose Corporation erklärt hiermit, dass dieses Produkt die wesentlichen Anforderungen gemäß Funkgeräte richtlinie 2017 und alle anderen zutreffenden UK-Richtlinien erfüllt. Die vollständige Konformitätserklärung ist einsehbar unter www.Bose.com/compliance

Wichtige Sicherheitshinweise

Verwenden Sie dieses Gerät nicht in der Nähe von Wasser.

Reinigen Sie das Gerät nur mit einem sauberen, trockenen Tuch.

Wenden Sie sich bei allen Reparatur- und Wartungsarbeiten nur an qualifiziertes Personal. Wartungsarbeiten sind in folgenden Fällen nötig: bei jeglichen Beschädigungen wie z. B. des Netzkabels oder Netzsteckers, wenn Flüssigkeiten oder Gegenstände in das Gehäuse gelangt sind, das Gerät Regen oder Feuchtigkeit ausgesetzt wurde, fallen gelassen wurde oder nicht ordnungsgemäß funktioniert.

WARNUNGEN/VORSICHTSMASSNAHMEN

- Verwenden Sie die Kopfhörer nicht längere Zeit bei hoher Lautstärke.
 - Um Gehörschäden zu vermeiden, sollten Sie die Kopfhörer bei angenehmer, mittlerer Lautstärke verwenden.
 - Schalten Sie die Lautstärke an Ihrem Gerät leiser, bevor Sie die Kopfhörer aufsetzen, und erhöhen Sie die Lautstärke dann nach und nach, bis ein angenehmes Niveau erreicht ist.
- Verwenden Sie die Kopfhörer NICHT beim Autofahren für Telefonanrufe oder andere Zwecke.
- Verwenden Sie die Kopfhörer NICHT im Geräuscherdrückungsmodus, wenn die Unmöglichkeit, Umgebungsgeräusche zu hören, eine Gefahr für Sie selbst oder andere darstellen könnte, z. B. beim Fahrradfahren oder Gehen in der Nähe von Verkehr, einer Baustelle oder Eisenbahnstrecke usw. Befolgen Sie die geltenden Gesetze zur Verwendung von Kopfhörern.
 - Schalten Sie die Kopfhörer aus oder verwenden Sie Kopfhörer ohne Geräuscherdrückung und passen Sie die Lautstärke an, um sicherzustellen, dass Sie Umgebungsgeräusch hören können, z. B. Alarime und Warnsignale.
 - Seien Sie sich bewusst, dass Geräusche, auf die Sie als Erinnerungen oder Warnungen vertrauen, sich bei Verwendung von Kopfhörern auch im Aware-Modus unterscheiden können.
- Verwenden Sie die Kopfhörer NICHT, wenn sie ein lautes ungewöhnliches Geräusch von sich geben. Schalten Sie in diesem Fall die Kopfhörer aus und wenden Sie sich an den Bose-Kundendienst.
- Entfernen Sie die Kopfhörer sofort, wenn Sie Wärme spüren oder nichts mehr hören.
- Verwenden Sie Handyadapter nicht zum Anschließen von Kopfhörern an Flugzeugsteckbuchsen, da dies zu Verletzungen oder zu Sachschäden aufgrund von Überhitzung führen kann.
- Verwenden Sie die Kopfhörer NICHT als Headsets für die Flugkommunikation.



Enthält kleine Teile, die verschluckt werden können und eine Erstickengefahr darstellen. Nicht geeignet für Kinder unter drei Jahren.



Dieses Produkt enthält magnetische Materialien. Wenden Sie sich an Ihren Arzt, wenn Sie wissen möchten, ob dies den Betrieb Ihres implantierten medizinischen Geräts beeinflussen kann.

- Um die Gefahr eines Brands oder Stromschlags zu verringern, sollten Sie das Produkt nicht Regen, Tropfen, Spritzern oder Feuchtigkeit aussetzen und keine mit Flüssigkeit gefüllten Gefäße wie Vasen auf oder in der Nähe des Produkts stellen.
- Halten Sie das Produkt von Feuer und Wärmequellen fern. Stellen Sie keine brennenden Kerzen oder ähnliches auf das Gerät oder in die Nähe des Geräts.
- Verwenden Sie dieses Produkt nur mit einem zugelassenen LPS-Netzteil, das die lokalen gesetzlichen Anforderungen erfüllt (z. B. UL, CSA, VDE, CCC).
- Nehmen Sie KEINE nicht genehmigten Änderungen an diesem Produkt vor.
- Wenn die Batterie ausläuft, achten Sie darauf, dass Ihre Haut oder Ihre Augen nicht in Kontakt mit der austretenden Flüssigkeit kommen. Suchen Sie im Falle eines Kontakts einen Arzt auf.
- Setzen Sie Produkte mit Batterien keiner großen Hitze aus (z. B. durch Aufbewahrung im direkten Sonnenlicht, Feuer oder ähnliches).
- Tragen Sie sie NICHT, während sie aufgeladen werden.

HINWEIS: Dieses Gerät wurde getestet und erfüllt die Grenzwerte für digitale Geräte der Klasse B gemäß Abschnitt 15 der FCC-Vorschriften. Diese Grenzwerte wurden festgelegt, um einen angemessenen Schutz gegen elektromagnetische Störungen bei einer Installation in Wohngebieten zu gewährleisten. Dieses Gerät erzeugt und verwendet Hochfrequenzstrahlung und kann sie auch aussenden. Daher verursacht das Gerät bei nicht ordnungsgemäßer Installation und Benutzung möglicherweise Störungen des Funkverkehrs. Es wird jedoch keine Garantie dafür gegeben, dass bei einer bestimmten Installation keine Störstrahlungen auftreten. Sollte dieses Gerät den Radio- oder Fernsehempfang stören (Sie können dies überprüfen, indem Sie das Gerät aus- und wiedereinschalten), so ist der Benutzer dazu angehalten, die Störungen durch eine der folgenden Maßnahmen zu beheben:

- Richten Sie das Empfangsprodukt oder die Antenne neu aus.
- Vergrößern Sie den Abstand zwischen dem Gerät und einem Radio- oder Fernsehempfänger.
- Schließen Sie das Gerät an eine Steckdose in einem anderen Stromkreis als den Empfänger an.
- Wenden Sie sich an einen Händler oder einen erfahrenen Radio-/Fernsehtechniker.

Veränderungen am Gerät, die nicht durch die Bose Corporation autorisiert wurden, können zur Folge haben, dass die Betriebserlaubnis für das Gerät erlischt.

Dieses Gerät erfüllt die Bestimmungen in Teil 15 der FCC-Vorschriften und die lizenzfreien RSS-Standards von ISED Canada. Der Betrieb unterliegt den beiden folgenden Bedingungen: (1) dieses Gerät darf keine Störungen verursachen und (2) dieses Gerät muss jegliche Störungen dulden, einschließlich Störungen, die zu einem unerwünschten Betrieb führen.

Dieses Gerät erfüllt die Strahlungsexpositionsgrenzwerte der FCC und ISED Canada für die allgemeine Bevölkerung. Der Sender darf nicht zusammen mit einer anderen Antenne oder einem anderen Sender aufgestellt oder betrieben werden.

Erfüllt die IMDA-Anforderungen.

FCC ID: A94437310

IC: 3232A-437310

CAN ICES-3(B)/NMB-3(B)

Für Europa:

Frequenzband des Betriebs 2.400 bis 2.483,5 MHz.

Maximale Sendeleistung weniger als 20 dBm EIRP.

Maximale Sendeleistung liegt unter den vorgeschriebenen Grenzwerten, sodass keine SAR-Tests nötig sind und gemäß den geltenden Vorschriften eine Befreiung gilt.



Dieses Symbol bedeutet, dass das Produkt nicht mit dem Hausmüll entsorgt werden darf, sondern bei einer geeigneten Sammelstelle für das Recycling abgegeben werden muss. Die ordnungsgemäße Entsorgung und das Recycling tragen dazu bei, die natürlichen Ressourcen, die Gesundheit und die Umwelt zu schützen.

Weitere Informationen zur Entsorgung und zum Recycling dieses Produkts erhalten Sie von Ihrer zuständigen Kommune, Ihrem Entsorgungsdienst oder dem Geschäft, in dem Sie dieses Produkt gekauft haben.

Technische Vorschriften für energiearme Funkfrequenzgeräte

Ohne Erlaubnis durch die NCC dürfen Firmen, Unternehmen oder Benutzer Folgendes nicht: die Frequenz ändern, die Übertragungsleistung verbessern oder die ursprünglichen Eigenschaften sowie die Leistung für ein zugelassenes energiearmes Funkfrequenzgerät ändern. Energiearme Funkfrequenzgeräte dürfen die Flugsicherheit nicht beeinträchtigen oder gesetzlich zulässige Kommunikation stören. Andernfalls muss der Benutzer den Betrieb sofort einstellen, bis keine Störung mehr auftritt. Besagte gesetzlich zulässige Kommunikation bedeutet Funkkommunikation, die in Übereinstimmung mit dem Telecommunications Management Act erfolgt. Energiearme Funkfrequenzgeräte müssen für Störung durch gesetzlich zulässige Kommunikation oder Geräte mit ISM-Funkwellenstrahlung empfindlich sein.

Versuchen Sie **NICHT**, die aufladbare Lithium-Ionen-Batterie aus diesem Produkt zu nehmen. Wenden Sie sich zum Herausnehmen an Ihren Bose-Händler oder einen anderen qualifizierten Fachmann.

Das Herausnehmen des aufladbaren Lithium-Ionen-Akkus aus diesem Produkt sollte nur durch einen Fachmann erfolgen. Bitte wenden Sie sich für weitere Informationen an Ihren örtlichen Bose-Händler oder sehen Sie unter products.bose.com/static/compliance/index.html nach.



Leere Batterien müssen getrennt entsorgt werden und gehören nicht in den Hausmüll. Nicht verbrennen.



Namen und Inhalt der giftigen oder gefährlichen Stoffe oder Elemente						
Name des Teils	Gefährliche Stoffe oder Elemente					
	Blei (Pb)	Quecksilber (Hg)	Kadmium (Cd)	Sechswertiges Chrom (CR(VI))	Polybromiertes Biphenyl (PBB)	Polybromiertes Diphenylether (PBDE)
PCBs	X	0	0	0	0	0
Metallteile	X	0	0	0	0	0
Kunststoffteile	0	0	0	0	0	0
Lautsprecher	X	0	0	0	0	0
Kabel	X	0	0	0	0	0
Diese Tabelle wurde in Übereinstimmung mit den Bestimmungen von SJ/T 11364 erstellt.						
O: Gibt an, dass dieser giftige oder gefährliche Stoff, der in allen homogenen Materialien für dieses Teil enthalten ist, unter den Grenzwerten gemäß GB/T 26572 liegt.						
X: Gibt an, dass dieser giftige oder gefährliche Stoff, der in mindestens einem der homogenen Materialien enthalten ist, die für dieses Teil verwendet wurden, über den Grenzwerten gemäß GB/T 26572 liegt.						

Herstellungsdatum: Die achte Ziffer in der Seriennummer gibt das Herstellungsjahr an: „2“ ist 2012 oder 2022.

China-Import: Bose Electronics (Shanghai) Company Limited, Level 6, Tower D, No. 2337 Gudai Rd. Minhang District, Shanghai 201100

EU-Import: Bose Products B.V., Gorslaan 60, 1441 RG Purmerend, Niederlande

Mexiko-Import: Bose de México S. de R.L. de C.V., Avenida Prado Sur #150, Piso 2, Interior 222 y 223, Colonia Lomas de Chapultepec V Sección, Miguel Hidalgo, Ciudad de México, C.P. 11000 Telefonnummer: +5255 (5202) 3545

Taiwan-Import: Bose Limited Taiwan Branch (H.K.), 9F., No. 10, Sec. 3, Minsheng E. Road, Zhongshan Dist. Taipei City 10480, Taiwan Telefonnummer: +886-2-2514 7676

UK-Import: Bose Limited, Bose House, Quayside Chatham Maritime, Chatham, Kent, ME4 4QZ, Vereinigtes Königreich

Eingangsnennleistung: 5 V --- 0,5 A

Ladetemperaturbereich: 0° C bis 45° C

Entladetemperaturbereich: -20° C bis 60° C

Modell 437310. Die CMIIT-ID ist auf der Hörmuschel unter dem Gitterstoff angegeben.

Bitte füllen Sie Folgendes aus und bewahren Sie es für Ihre Unterlagen auf:

Die Serien- und Modellnummern befinden sich in der Hörmuschel unter dem Gitterstoff.

Seriennummer: _____

Modellnummer: _____

Bewahren Sie die Kaufquittung zusammen mit der Bedienungsanleitung auf. Jetzt ist ein guter Zeitpunkt, um Ihr Bose-Produkt zu registrieren. Sie können dies ganz einfach auf worldwide.bose.com/ProductRegistration

Sicherheitshinweise



Dieses Produkt kann Sicherheitsupdates von Bose über die Bose Music App empfangen. Um Sicherheitsupdates über die mobile Anwendung zu empfangen, müssen Sie den Produkteinrichtungsvorgang in der Bose Music App abschließen. **Wenn Sie den Einrichtungsvorgang nicht abschließen, sind Sie für das Installieren von Sicherheitsupdates verantwortlich, die Bose über btu.bose.com zur Verfügung stellt.**

Apple, das Apple-Logo, iPad, iPhone und iPod sind Marken von Apple Inc., die in den USA und anderen Ländern eingetragen sind. App Store ist eine Dienstleistungsmarke von Apple Inc. Die Marke „iPhone“ wird in Japan mit einer Lizenz von Aiphone K.K. verwendet.

Die Verwendung des Aufklebers „Made for Apple“ bedeutet, dass ein elektronisches Zubehör speziell für die Verwendung mit Apple-Produkten entwickelt wurde, die auf dem Aufkleber angegeben sind, und vom Entwickler für die Erfüllung der Apple-Leistungsstandards zertifiziert wurde. Apple übernimmt keine Verantwortung für den Betrieb dieses Geräts oder die Einhaltung von Sicherheits- und gesetzlichen Standards.

Die *Bluetooth*[®] Wortmarke und Logos sind eingetragene Marken der Bluetooth SIG, Inc. Jegliche Nutzung dieser Marken durch die Bose Corporation erfolgt unter Lizenz.

Google Play ist eine Marke von Google LLC.

USB Type-C[®] und USB-C[®] sind eingetragene Marken des USB Implementers Forum.

Bose, Bose Home Speaker, Bose Music, das Bose Music Logo, Bose Smart Soundbar, Bose Smart Speaker, Bose Soundbar, QuietComfort und SimpleSync sind Marken der Bose Corporation.

Bose Corporation Unternehmenszentrale: 1-877-230-5639

©2022 Bose Corporation. Dieses Dokument darf ohne vorherige schriftliche Genehmigung weder ganz noch teilweise reproduziert, verändert, vertrieben oder auf andere Weise verwendet werden.

The following license disclosures apply to certain third-party software packages used as components in the product.

Package: FreeRTOS

Copyright © Amazon Web Services, Inc. or its affiliates. All rights reserved.

The FreeRTOS package is subject to the license terms reprinted below:

MIT License

Permission is hereby granted, free of charge, to any person obtaining a copy of this software and associated documentation files (the “Software”), to deal in the Software without restriction, including without limitation the rights to use, copy, modify, merge, publish, distribute, sublicense, and/or sell copies of the Software, and to permit persons to whom the Software is furnished to do so, subject to the following conditions:

The above copyright notice and this permission notice shall be included in all copies or substantial portions of the Software.

THE SOFTWARE IS PROVIDED “AS IS”, WITHOUT WARRANTY OF ANY KIND, EXPRESS OR IMPLIED, INCLUDING BUT NOT LIMITED TO THE WARRANTIES OF MERCHANTABILITY, FITNESS FOR A PARTICULAR PURPOSE AND NONINFRINGEMENT. IN NO EVENT SHALL THE AUTHORS OR COPYRIGHT HOLDERS BE LIABLE FOR ANY CLAIM, DAMAGES OR OTHER LIABILITY, WHETHER IN AN ACTION OF CONTRACT, TORT OR OTHERWISE, ARISING FROM, OUT OF OR IN CONNECTION WITH THE SOFTWARE OR THE USE OR OTHER DEALINGS IN THE SOFTWARE.

Package: Nanopb

Copyright © 2011 Petteri Aimonen <jpa at nanopb.mail.kapsi.fi>.

The Nanopb package is subject to the license terms reprinted below:

Zlib License

© 2011 Petteri Aimonen <jpa at nanopb.mail.kapsi.fi>

This software is provided ‘as-is’, without any express or implied warranty. In no event will the authors be held liable for any damages arising from the use of this software.

Permission is granted to anyone to use this software for any purpose, including commercial applications, and to alter it and redistribute it freely, subject to the following restrictions:

1. The origin of this software must not be misrepresented; you must not claim that you wrote the original software. If you use this software in a product, an acknowledgment in the product documentation would be appreciated but is not required.
2. Altered source versions must be plainly marked as such, and must not be misrepresented as being the original software.
3. This notice may not be removed or altered from any source distribution.

Package: Mbed TLS 2.16.1

© ARM Limited. All rights reserved.

The Mbed TLS package is subject to the license terms reprinted below:

Apache License

Version 2.0, January 2004

<http://www.apache.org/licenses/>

TERMS AND CONDITIONS FOR USE, REPRODUCTION, AND DISTRIBUTION

1. Definitions.
“License” shall mean the terms and conditions for use, reproduction, and distribution as defined by Sections 1 through 9 of this document.

“Licensor” shall mean the copyright owner or entity authorized by the copyright owner that is granting the License.

“Legal Entity” shall mean the union of the acting entity and all other entities that control, are controlled by, or are under common control with that entity. For the purposes of this definition, “control” means (i) the power, direct or indirect, to cause the direction or management of such entity, whether by contract or otherwise, or (ii) ownership of fifty percent (50%) or more of the outstanding shares, or (iii) beneficial ownership of such entity.

“You” (or “Your”) shall mean an individual or Legal Entity exercising permissions granted by this License.

“Source” form shall mean the preferred form for making modifications, including but not limited to software source code, documentation source, and configuration files.

“Object” form shall mean any form resulting from mechanical transformation or translation of a Source form, including but not limited to compiled object code, generated documentation, and conversions to other media types.

“Work” shall mean the work of authorship, whether in Source or Object form, made available under the License, as indicated by a copyright notice that is included in or attached to the work (an example is provided in the Appendix below).

“Derivative Works” shall mean any work, whether in Source or Object form, that is based on (or derived from) the Work and for which the editorial revisions, annotations, elaborations, or other modifications represent, as a whole, an original work of authorship. For the purposes of this License, Derivative Works shall not include works that remain separable from, or merely link (or bind by name) to the interfaces of, the Work and Derivative Works thereof.

“Contribution” shall mean any work of authorship, including the original version of the Work and any modifications or additions to that Work or Derivative Works thereof, that is intentionally submitted to Licensor for inclusion in the Work by the copyright owner or by an individual or Legal Entity authorized to submit on behalf of the copyright owner. For the purposes of this definition, “submitted” means any form of electronic, verbal, or written communication sent to the Licensor or its representatives, including but not limited to communication on electronic mailing lists, source code control systems, and issue tracking systems that are managed by, or on behalf of, the Licensor for the purpose of discussing and improving the Work, but excluding communication that is conspicuously marked or otherwise designated in writing by the copyright owner as “Not a Contribution.”

“Contributor” shall mean Licensor and any individual or Legal Entity on behalf of whom a Contribution has been received by Licensor and subsequently incorporated within the Work.

2. Grant of Copyright License. Subject to the terms and conditions of this License, each Contributor hereby grants to You a perpetual, worldwide, non-exclusive, no-charge, royalty-free, irrevocable copyright license to reproduce, prepare Derivative Works of, publicly display, publicly perform, sublicense, and distribute the Work and such Derivative Works in Source or Object form.
3. Grant of Patent License. Subject to the terms and conditions of this License, each Contributor hereby grants to You a perpetual, worldwide, non-exclusive, no-charge, royalty-free, irrevocable (except as stated in this section) patent license to make, have made, use, offer to sell, sell, import, and otherwise transfer the Work, where such license applies only to those patent claims licensable by such Contributor that are necessarily infringed by their Contribution(s) alone or by combination of their Contribution(s) with the Work to which such Contribution(s) was submitted. If You institute patent litigation against any entity (including a cross-claim or counterclaim in a lawsuit) alleging that the Work or a Contribution incorporated within the Work constitutes direct or contributory patent infringement, then any patent licenses granted to You under this License for that Work shall terminate as of the date such litigation is filed.
4. Redistribution. You may reproduce and distribute copies of the Work or Derivative Works thereof in any medium, with or without modifications, and in Source or Object form, provided that You meet the following conditions:
 - a. You must give any other recipients of the Work or Derivative Works a copy of this License; and
 - b. You must cause any modified files to carry prominent notices stating that You changed the files; and
 - c. You must retain, in the Source form of any Derivative Works that You distribute, all copyright, patent, trademark, and attribution notices from the Source form of the Work, excluding those notices that do not pertain to any part of the Derivative Works; and

d. If the Work includes a “NOTICE” text file as part of its distribution, then any Derivative Works that You distribute must include a readable copy of the attribution notices contained within such NOTICE file, excluding those notices that do not pertain to any part of the Derivative Works, in at least one of the following places: within a NOTICE text file distributed as part of the Derivative Works; within the Source form or documentation, if provided along with the Derivative Works; or, within a display generated by the Derivative Works, if and wherever such third-party notices normally appear. The contents of the NOTICE file are for informational purposes only and do not modify the License. You may add Your own attribution notices within Derivative Works that You distribute, alongside or as an addendum to the NOTICE text from the Work, provided that such additional attribution notices cannot be construed as modifying the License.

You may add Your own copyright statement to Your modifications and may provide additional or different license terms and conditions for use, reproduction, or distribution of Your modifications, or for any such Derivative Works as a whole, provided Your use, reproduction, and distribution of the Work otherwise complies with the conditions stated in this License.

5. Submission of Contributions. Unless You explicitly state otherwise, any Contribution intentionally submitted for inclusion in the Work by You to the Licensor shall be under the terms and conditions of this License, without any additional terms or conditions. Notwithstanding the above, nothing herein shall supersede or modify the terms of any separate license agreement you may have executed with Licensor regarding such Contributions.
6. Trademarks. This License does not grant permission to use the trade names, trademarks, service marks, or product names of the Licensor, except as required for reasonable and customary use in describing the origin of the Work and reproducing the content of the NOTICE file.
7. Disclaimer of Warranty. Unless required by applicable law or agreed to in writing, Licensor provides the Work (and each Contributor provides its Contributions) on an “AS IS” BASIS, WITHOUT WARRANTIES OR CONDITIONS OF ANY KIND, either express or implied, including, without limitation, any warranties or conditions of TITLE, NON-INFRINGEMENT, MERCHANTABILITY, or FITNESS FOR A PARTICULAR PURPOSE. You are solely responsible for determining the appropriateness of using or redistributing the Work and assume any risks associated with Your exercise of permissions under this License.
8. Limitation of Liability. In no event and under no legal theory, whether in tort (including negligence), contract, or otherwise, unless required by applicable law (such as deliberate and grossly negligent acts) or agreed to in writing, shall any Contributor be liable to You for damages, including any direct, indirect, special, incidental, or consequential damages of any character arising as a result of this License or out of the use or inability to use the Work (including but not limited to damages for loss of goodwill, work stoppage, computer failure or malfunction, or any and all other commercial damages or losses), even if such Contributor has been advised of the possibility of such damages.
9. Accepting Warranty or Additional Liability. While redistributing the Work or Derivative Works thereof, You may choose to offer, and charge a fee for, acceptance of support, warranty, indemnity, or other liability obligations and/or rights consistent with this License. However, in accepting such obligations, You may act only on Your own behalf and on Your sole responsibility, not on behalf of any other Contributor, and only if You agree to indemnify, defend, and hold each Contributor harmless for any liability incurred by, or claims asserted against, such Contributor by reason of your accepting any such warranty or additional liability.

END OF TERMS AND CONDITIONS

©2022 Bose Corporation

Licensed under the Apache License, Version 2.0 (the “License”); you may not use this file except in compliance with the License.

You may obtain a copy of the License at: <http://www.apache.org/licenses/LICENSE-2.0>

Unless required by applicable law or agreed to in writing, software distributed under the License is distributed on an “AS IS” BASIS, WITHOUT WARRANTIES OR CONDITIONS OF ANY KIND, either express or implied.

See the License for the specific language governing permissions and limitations under the License.

LIEFERUMFANG

Inhalt 13

BOSE MUSIC APP

Herunterladen der Bose Music App 14
 Hinzufügen der Kopfhörer zu einem vorhandenen Konto..... 14

KOPFHÖRER-BEDIENELEMENTE

Einschalten 16
 Standby-Timer..... 16
 Ausschalten..... 17
 Kopfhörer-Funktionen 18
 Medienwiedergabe und Lautstärke 18
 Telefonanrufe..... 19
 Aktionstaste..... 20

GERÄUSCHUNTERDRÜCKUNG

Geräuschunterdrückungsmodi 21
 Ändern des Geräuschunterdrückungsmodus 21

SPRACHSTEUERUNG

Aufrufen der Sprachsteuerung..... 22

BLUETOOTH®-VERBINDUNGEN

Verbinden mithilfe des *Bluetooth*-Menüs auf dem Mobilgerät 23
 Trennen eines Mobilgeräts 25
 Ein Mobilgerät erneut verbinden 25
 Verbinden eines anderen Mobilgeräts 25
 Identifizieren verbundener Mobilgeräte..... 25
 Umschalten zwischen zwei verbundenen Mobilgeräten 25
 Bereits verbundenes Gerät erneut verbinden 26
 Löschen der Kopfhörer-Geräteleiste 26

KABELGEBUNDENE VERBINDUNGEN

Anschließen des Audiokabels 27

BATTERIE

Aufladen der Kopfhörer 28
 Ladedauer..... 28
 Akustische Anzeige des Batterieladezustands..... 28

KOPFHÖRER-STATUS

Bluetooth-Status 29
 Batteriestatus 29
 Ladestatus 30
 Update- und Fehlerstatus 30

BOSE-PRODUKTE VERBINDEN

Verbinden mit einem Bose Smart Speaker oder einer
 Bose Smart Soundbar 31
 Vorteile..... 31
 Kompatible Produkte 31
 Mithilfe der Bose Music App verbinden..... 31
 Erneutes Verbinden mit einem Bose Smart Speaker oder einer
 Bose Smart Soundbar 32

PFLEGE UND WARTUNG

Aufbewahrung der Kopfhörer 33
 Reinigen der Kopfhörer 34
 Ersatzteile und Zubehör..... 34
 Eingeschränkte Garantie..... 34
 Ort der Seriennummer 35

FEHLERBEHEBUNG

Versuchen Sie zuerst diese Lösungen 36
Andere Lösungen..... 36
Wiederherstellen der werkseitigen Einstellungen der Kopfhörer..... 39

INHALT

Überprüfen Sie, ob die folgenden Teile enthalten sind:



Bose QuietComfort 45 headphones

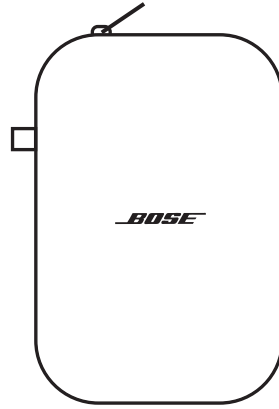

Weiches Transportetui

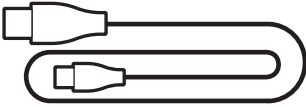

USB Type-C®-Kabel

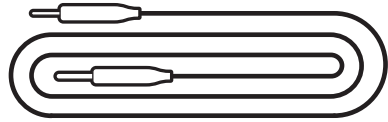

3,5-mm-auf-2,5-mm-Audiokabel

HINWEIS: Sollten Teile des Produkts beschädigt sein, verwenden Sie es nicht. Wenden Sie sich an den Bose-Fachhandel oder den Bose-Kundendienst.

Besuchen Sie: support.Bose.com/QCSE

Mit der Bose Music App können Sie die Kopfhörer von jedem Mobilgerät, z. B. einem Smartphone oder Tablet, aus steuern.

Mithilfe der App können Sie *Bluetooth*-Verbindungen verwalten, Kopfhörereinstellungen verwalten, die Sprache der Sprachbefehle auswählen und Zugriff auf neue Funktionen über Updates erhalten.

HINWEIS: Wenn Sie bereits ein Bose Music-Konto für ein anderes Bose-Produkt erstellt haben, fügen Sie die Kopfhörer zu Ihrem vorhandenen Konto hinzu (siehe unten auf Seite 14).

HERUNTERLADEN DER BOSE MUSIC APP

1. Laden Sie auf Ihrem Mobilgerät die Bose Music App herunter.

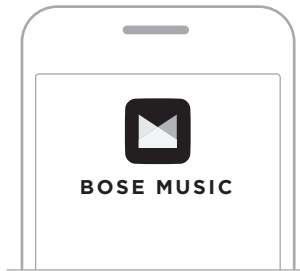

2. Befolgen Sie die Anweisungen in der App.

HINZUFÜGEN DER KOPFHÖRER ZU EINEM VORHANDENEN KONTO

Um Ihre Bose QuietComfort 45-Kopfhörer hinzuzufügen, öffnen Sie die Bose Music App und fügen Sie die Kopfhörer hinzu.

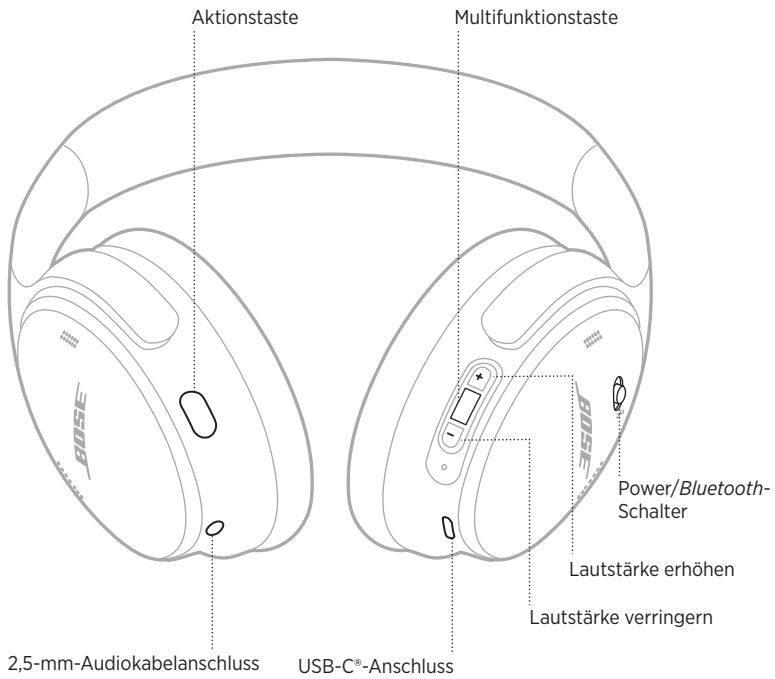

EINSCHALTEN

Schieben Sie den *Power/Bluetooth*-Schalter an der rechten Hörmuschel nach rechts.

Ein Sprachbefehl gibt den Batterieladezustand an und das Statuslämpchen leuchtet gemäß dem aktuellen Ladezustand (siehe Seite 29).



Standby-Timer

Der Standby-Timer spart Batterieleistung, wenn die Kopfhörer nicht verwendet werden.

Um den Standby-Timer einzurichten und anzupassen, verwenden Sie die Bose Music App.

AUSSCHALTEN

Schieben Sie den Power/*Bluetooth*-Schalter nach links.



HINWEIS: Wenn die Kopfhörer ausgeschaltet sind, ist die Geräuschunterdrückung deaktiviert.

KOPFHÖRER-FUNKTIONEN

Die Kopfhörer-Bedienelemente befinden sich an der Rückseite der rechten Hörmuschel.

Medienwiedergabe und Lautstärke

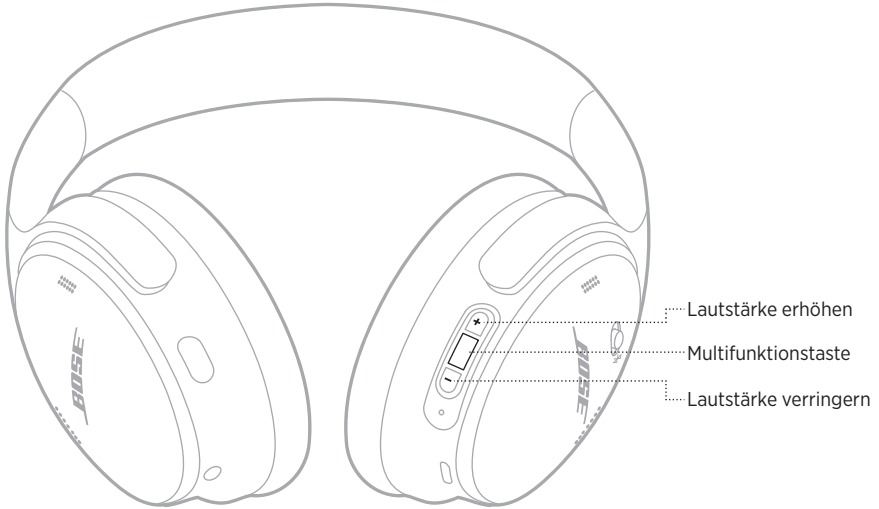

FUNKTION	VORGEHENSWEISE
Wiedergabe/Pause	Drücken Sie die Multifunktionstaste.
Vorwärts springen	Drücken Sie die Multifunktionstaste zwei Mal.
Rückwärts springen	Drücken Sie die Multifunktionstaste drei Mal.
Lautstärke erhöhen	Drücken Sie +.
Lautstärke verringern	Drücken Sie —.

HINWEISE:

- Um die Lautstärke schnell zu erhöhen, halten Sie + gedrückt.
- Um die Lautstärke schnell zu verringern, halten Sie — gedrückt.

Telefonanrufe

Die Multifunktionstaste befindet sich an der Rückseite der linken Hörmuschel. Das Mikrofon befindet sich in der Nähe der Vorderseite der rechten Hörmuschel.

Die Aktionstaste befindet sich an der Rückseite der linken Hörmuschel.

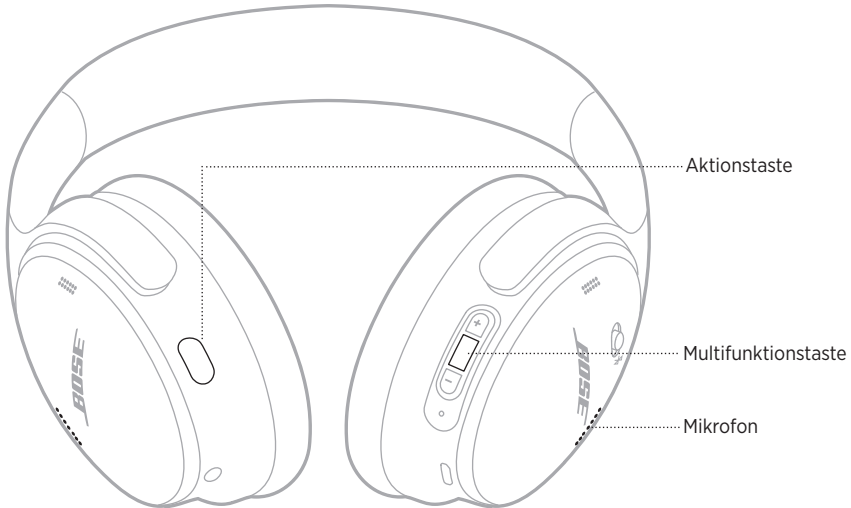

FUNKTION	VORGEHENSWEISE
Anruf annehmen/beenden	Drücken Sie die Multifunktionstaste.
Ankommenden Anruf ablehnen	Halten Sie die Multifunktionstaste 1 Sekunde lang gedrückt.
Zweiten eingehenden Anruf entgegennehmen und aktuellen Anruf auf Warten stellen	Wenn während eines Anrufs ein zweiter eingehender Anruf klingelt, drücken Sie die Multifunktionstaste.
Zweiten eingehenden Anruf ablehnen und beim aktuellen Anruf bleiben	Wenn während eines Anrufs ein zweiter eingehender Anruf klingelt, halten Sie die Multifunktionstaste 1 Sekunde lang gedrückt.
Zwischen zwei Anrufen umschalten	Während zwei Anrufe aktiv sind, drücken Sie die Multifunktionstaste zwei Mal.
Telefonkonferenz erstellen	Während zwei Anrufe aktiv sind, halten Sie die Multifunktionstaste 3 Sekunden lang gedrückt.
Einen Anruf stumm schalten/ Stummschaltung aufheben	Drücken Sie die Aktionstaste während eines Anrufs zwei Mal.

Aktionstaste

Mit der Aktionstaste können Sie schnell und einfach zwischen den Geräuschunterdrückungsmodi umschalten.

Die Aktionstaste befindet sich an der Rückseite der linken Hörmuschel.

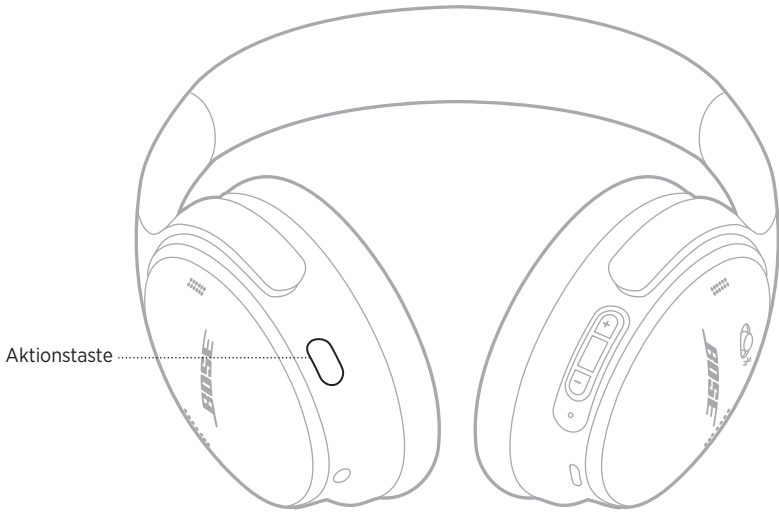

Zum Umschalten zwischen dem leisen Modus und dem Aware-Modus drücken Sie die Aktionstaste.

Weitere Informationen über die Geräuschunterdrückungsmodi finden Sie unter Seite 21.

Geräuschunterdrückung reduziert unerwünschte Geräusche und sorgt für einen natürlicheren Klang. Sie können zwischen zwei Geräuschunterdrückungsmodi auswählen: Leise und Aware.

Der leise Modus ermöglicht das Blockieren von störenden Geräuschen unter Verwendung der höchsten Geräuschunterdrückungsstufe.

Der Aware-Modus bietet volle Transparenz und ermöglicht es Ihnen, während der Audiowiedergabe Umgebungsgeräusche zu hören.

Somit lässt sich der Geräuschunterdrückungsmodus an Ihre Hörvorlieben oder Umgebung anpassen.

GERÄUSCHUNTERDRÜCKUNGSMODI

MODUS	BESCHREIBUNG
Leise	Erstklassige Geräuschunterdrückung mit Bose Spitzenklang.
Aware	Hören Sie Umgebungsgeräusche während der Audiowiedergabe.

HINWEIS: Beim Einschalten ist der Kopfhörer auf den zuletzt verwendeten Modus voreingestellt.

ÄNDERN DES GERÄUSCHUNTERDRÜCKUNGSMODUS

Um den Geräuschunterdrückungsmodus zu ändern, drücken Sie die Aktionstaste.

Ein Sprachbefehl gibt den ausgewählten Geräuschunterdrückungsmodus bekannt.

TIPP: Sie können den Geräuschunterdrückungsmodus auch mithilfe der Bose Music App ändern.

AUFRUFEN DER SPRACHSTEUERUNG

Sie können die Kopfhörer verwenden, um auf die Sprachsteuerung Ihres Mobilgeräts zuzugreifen. Um auf die Sprachsteuerung zuzugreifen, halten Sie die Multifunktionstaste 1 Sekunde lang gedrückt.

Die Multifunktionstaste befindet sich an der Rückseite der linken Hörmuschel.

HINWEIS: Während eines Anrufs können Sie nicht auf die Sprachsteuerung zugreifen.

VERBINDEN MITHILFE DES *BLUETOOTH*-MENÜS AUF DEM MOBILGERÄT

Sie können bis zu acht Geräte in der Geräteliste der Kopfhörer speichern, und die Kopfhörer können mit zwei Geräten gleichzeitig aktiv verbunden sein. Sie können Ton jeweils nur von einem Gerät wiedergeben.

HINWEIS: Verwenden Sie für ein optimales Erlebnis die Bose Music App, um Ihr Mobilgerät einzurichten und zu verbinden (siehe Seite 14).

1. Schieben Sie den *Power/Bluetooth*-Schalter nach rechts \rightarrow und halten Sie ihn 3 Sekunden lang.

Sie hören „Bereit zum Verbinden“ und das Statuslämpchen blinkt blau.



2. Aktivieren Sie die *Bluetooth*-Funktion auf Ihrem Gerät.

HINWEIS: Die *Bluetooth*-Funktion finden Sie normalerweise im Einstellungen-Menü.

3. Wählen Sie die Kopfhörer aus der Geräteliste aus.

TIPP: Suchen Sie nach dem Namen, den Sie in der Bose Music App für die Kopfhörer eingegeben haben. Wenn Sie dem Kopfhörer keinen Namen gegeben haben, wird der voreingestellte Name angezeigt.



Nach dem Verbinden ertönt die Ansage „Verbunden mit <Name des Mobilgeräts>“ und das Statuslämpchen leuchtet 10 Sekunden lang blau.

TRENNEN EINES MOBILGERÄTS

Verwenden Sie die Bose Music App, um Ihr Mobilgerät zu trennen.

TIPP: Sie können auch die *Bluetooth*-Einstellungen verwenden, um Ihr Gerät zu trennen. Durch Deaktivieren der *Bluetooth*-Funktion werden alle anderen Geräte getrennt.

EIN MOBILGERÄT ERNEUT VERBINDEN

Wenn die Kopfhörer eingeschaltet werden, verbinden sie sich automatisch wieder mit den zwei zuletzt verbundenen Geräten.

HINWEISE:

- Das Gerät muss sich innerhalb der Reichweite (9 m) befinden und eingeschaltet sein.
- Stellen Sie sicher, dass die *Bluetooth*-Funktion an Ihrem Mobilgerät aktiviert ist.

VERBINDEN EINES ANDEREN MOBILGERÄTS

Um ein anderes Gerät zu verbinden, laden Sie die Bose Music App herunter (siehe Seite 14) oder verwenden Sie das *Bluetooth*-Menü auf Ihrem Mobilgerät (siehe Seite 23).

HINWEIS: Sie können immer nur Ton von einem Gerät gleichzeitig wiedergeben.

IDENTIFIZIEREN VERBUNDENER MOBILGERÄTE

Schieben Sie den *Power/Bluetooth*-Schalter nach rechts \rightarrow und lassen Sie ihn los, um zu hören, welches Gerät zurzeit verbunden ist.

UMSCHALTEN ZWISCHEN ZWEI VERBUNDENEN MOBILGERÄTEN

1. Halten Sie den Ton auf dem ersten Mobilgerät an.
2. Geben Sie Ton auf dem zweiten Mobilgerät wieder.

HINWEIS: Die Kopfhörer können unabhängig davon, auf welchem Gerät die Audiowiedergabe erfolgt, Telefonanrufe von beiden Geräten empfangen.

BEREITS VERBUNDENES GERÄT ERNEUT VERBINDEN

1. Schieben Sie den *Power/Bluetooth*-Schalter nach rechts ☒ und lassen Sie ihn los, um zu hören, welches Gerät verbunden ist.
2. Schieben Sie innerhalb von 2 Sekunden den *Power/Bluetooth*-Schalter nach rechts ☒ und lassen Sie ihn wieder los, um das nächste Gerät in der Kopfhörergeräteliste zu verbinden.
3. Wiederholen Sie dies, bis Sie den korrekten Gerätenamen hören.
Sie hören einen Ton, der angibt, dass das Gerät verbunden wird.
4. Geben Sie Ton auf dem verbundenen Mobilgerät wieder.

HINWEIS: Wenn bereits zwei Geräte mit den Kopfhörern verbunden sind, ersetzt das neu verbundene Gerät das zweite Gerät, das vorher verbunden war.

LÖSCHEN DER KOPFHÖRER-GERÄTELISTE

1. Schieben Sie den *Power/Bluetooth*-Schalter nach rechts ☒ und halten Sie ihn 15 Sekunden lang gedrückt, bis Sie „*Bluetooth*-Geräteliste gelöscht. Bereit für die Verbindung“ hören.
2. Löschen Sie die Kopfhörer aus der *Bluetooth*-Liste am Mobilgerät.
Alle Geräte werden gelöscht und die Kopfhörer sind für das Verbinden bereit.

ANSCHLIESSEN DES AUDIOKABELS

Verwenden Sie das 2,5-mm-auf-3,5-mm-Kabel, um ein nicht drahtloses Gerät anzuschließen oder die Kopfhörer weiter zu verwenden, wenn die Batterie leer ist.

1. Schließen Sie das Kabel an den 2,5-mm-Anschluss an der linken Hörmuschel an.



2. Schließen Sie das andere Ende des Kabels an den 3,5-mm-Anschluss Ihres Geräts an.

HINWEIS: Sie können die Kopfhörer ein- oder ausgeschaltet verwenden, wenn das Audiokabel angeschlossen ist.

AUFLADEN DER KOPFHÖRER

1. Verbinden Sie das kleine Ende des USB-Kabels mit dem USB-C-Anschluss in der rechten Hörmuschel.
2. Verbinden Sie das andere Ende mit einem USB-Wandladegerät.



HINWEISE:

- Sobald das Aufladen der Kopfhörer beginnt, blinkt das Statuslämpchen 10 Sekunden lang weiß. Wenn sie voll aufgeladen sind, leuchtet das Statuslämpchen weiß.
- Während des Aufladens erfolgt keine Wiedergabe über die Kopfhörer.

Ladedauer

Das vollständige Aufladen kann bis zu 2,5 Stunden dauern.

Akustische Anzeige des Batterieladestatus

Jedes Mal, wenn Sie die Kopfhörer einschalten, gibt ein Sprachbefehl den Batterieladestatus an. Wenn die Kopfhörerbatterie schwach ist, hören Sie Kopfhörer „Batterie schwach, bitte jetzt aufladen“.

HINWEIS: Zur visuellen Prüfung der Batterie verwenden Sie die Statuslämpchen an der rechten Hörmuschel. Weitere Informationen finden Sie unter „Batteriestatus“ auf Seite 29.

Das Statuslämpchen befindet sich an der rechten Hörmuschel.



BLUETOOTH-STATUS

Zeigt den *Bluetooth* Verbindungsstatus an.

AKTIVITÄT DER LÄMPCHEN	SYSTEMZUSTAND
Blinkt blau	Bereit für die Verbindung
Leuchtet blau (10 Sekunden)	Verbunden

BATTERIESTATUS

Zeigt den Batterieladezustand an.

AKTIVITÄT DER LÄMPCHEN	SYSTEMZUSTAND
Leuchtet weiß	Halb bis voll aufgeladen
Leuchtet gelb	Fast entladen

TIPP: Sie können den Batterieladezustand außerdem mithilfe der Bose Music App überprüfen.

LADESTATUS

Zeigt den Ladezustand.

AKTIVITÄT DER LÄMPCHEN	SYSTEMZUSTAND
Blinkt 2 Mal weiß	Aufladen beginnt
Leuchtet gelb	Aufladen
Leuchtet weiß	Vollständige Aufladung

UPDATE- UND FEHLERSTATUS

Zeigt den Update- und Fehlerstatus.

AKTIVITÄT DER LÄMPCHEN	SYSTEMZUSTAND
Blinkt schnell weiß (10 Sekunden)	Software wird aktualisiert (über USB)
Blinkt langsam weiß (30 bis 60 Sekunden)	Software wird aktualisiert (drahtlos)
Blinkt gelb und weiß	Fehler – Wenden Sie sich an den Bose-Kundendienst

VERBINDEN MIT EINEM BOSE SMART SPEAKER ODER EINER BOSE SMART SOUNDBAR

Mit der SimpleSync™-Technologie können Sie die Kopfhörer für ein persönliches Hörerlebnis mit einer Bose Smart Soundbar oder einem Bose Smart Speaker verbinden.

Vorteile

- Verwenden Sie unabhängige Lautstärkeregelungen an jedem Produkt, um die Bose Smart Soundbar leiser einzustellen oder stummzuschalten, während Sie über die Kopfhörer weiterhin so laut hören, wie Sie möchten.
- Hören Sie Musik im Raum nebenan ganz klar, indem Sie Ihre Kopfhörer mit Ihrem Bose Smart Speaker verbinden.

HINWEIS: SimpleSync™-Technologie hat eine *Bluetooth*-Reichweite von bis zu 9 Metern. Wände und die Art der verwendeten Baumaterialien können den Empfang beeinträchtigen.

Kompatible Produkte

Sie können die Kopfhörer mit einem Bose Smart Speaker oder einer Bose Smart Soundbar verbinden.

Beliebte kompatible Produkte sind z. B.:

- Bose Smart Soundbar 700/Bose Soundbar 700
- Bose Soundbar 500
- Bose Smart Speaker 500/Bose Home Speaker 500
- Bose Home Speaker 300
- Bose Portable Smart Speaker/Bose Portable Home Speaker

Neue Produkte werden regelmäßig hinzugefügt. Eine vollständige Liste und weitere Informationen finden Sie unter: worldwide.Bose.com/Support/Groups

Mithilfe der Bose Music App verbinden

1. Schieben Sie den *Power/Bluetooth*-Schalter an den Kopfhörern nach rechts ☞ und halten Sie ihn 3 Sekunden lang.

Sie hören „Bereit zum Verbinden eines anderen Geräts“ und das Statuslämpchen blinkt blau.

2. Verwenden Sie die Bose Music App, um die Kopfhörer mit einem kompatiblen Bose-Produkt zu verbinden. Weitere Informationen finden Sie unter: worldwide.Bose.com/Support/Groups

HINWEISE:

- Vergewissern Sie sich, dass die Kopfhörer sich höchstens 9 m von der Soundbar oder dem Lautsprecher entfernt befinden.
- Sie können die Kopfhörer nur mit jeweils einem Produkt gleichzeitig verbinden.

ERNEUTES VERBINDEN MIT EINEM BOSE SMART SPEAKER ODER EINER BOSE SMART SOUNDBAR

Schalten Sie die Kopfhörer ein (siehe „Einschalten“ auf Seite 16).

Die Kopfhörer versuchen, sich mit den zwei zuletzt verbundenen *Bluetooth*-Geräten zu verbinden, z. B. Ihrer Soundbar oder Ihrem Lautsprecher.

HINWEISE:

- Die Soundbar oder der Lautsprecher muss sich innerhalb der Reichweite (9 m) befinden und eingeschaltet sein.
- Wenn sich die Kopfhörer nicht erneut verbinden, sehen Sie unter „Kopfhörer verbinden sich nicht erneut mit einer vorher verbundenen Bose Smart Soundbar oder einem vorher verbundenen Bose Smart Speaker“ auf Seite 38 nach.

AUFBEWAHRUNG DER KOPFHÖRER

Die Hörmuscheln können zur einfachen, praktischen Aufbewahrung gedreht werden. Legen Sie die Kopfhörer flach in das Etui.

1. Drehen Sie beide Hörmuscheln nach innen, sodass sie flach liegen.



2. Klappen Sie die linke Hörmuschel in Richtung Kopfbügel.

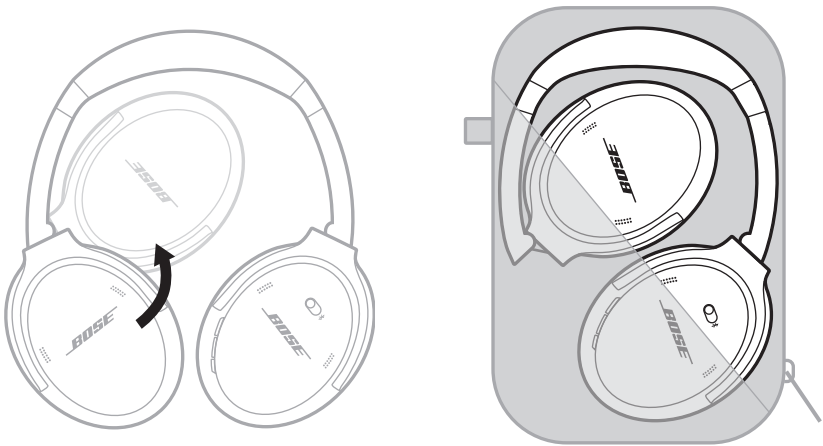

HINWEISE:

- Schalten Sie die Kopfhörer bei Nichtgebrauch aus.
- Wenn Sie die Kopfhörer länger als einige Monate aufbewahren, sollten Sie darauf achten, dass die Batterie vollständig geladen ist.

REINIGEN DER KOPFHÖRER

Wischen Sie die äußeren Flächen mit einem weichen, trockenen Tuch ab.

Achten Sie darauf, dass keine Feuchtigkeit ins Innere der Hörmuscheln gelangt.

ERSATZTEILE UND ZUBEHÖR

Ersatzteile und Zubehör können über den Bose-Kundendienst bestellt werden. Besuchen Sie: support.bose.com/QCSE

EINGESCHRÄNKTE GARANTIE

Für Ihre Kopfhörer gilt eine eingeschränkte Garantie. Nähere Informationen zur eingeschränkten Garantie finden Sie auf unserer Website unter worldwide.bose.com/Warranty.

Eine Anleitung zum Registrieren Ihres Produkts finden Sie unter worldwide.bose.com/ProductRegistration. Ihre eingeschränkte Garantie ist jedoch unabhängig von der Registrierung gültig.

ORT DER SERIENNUMMER

Die Seriennummer befindet auf der Hörmuschel unter dem Gitterstoff. Der Gitterstoff ist die innere Abschirmung, die die Komponenten in der Hörmuschel abdeckt und schützt.

Um die Seriennummer zu sehen, greifen Sie den Gitterstoff am oberen Rand und ziehen Sie ihn vorsichtig weg.

ACHTUNG: Achten Sie darauf, keine anderen Komponenten in der Hörmuschel herunterzudrücken oder zu entfernen, da dies die Kopfhörer beschädigen könnte.

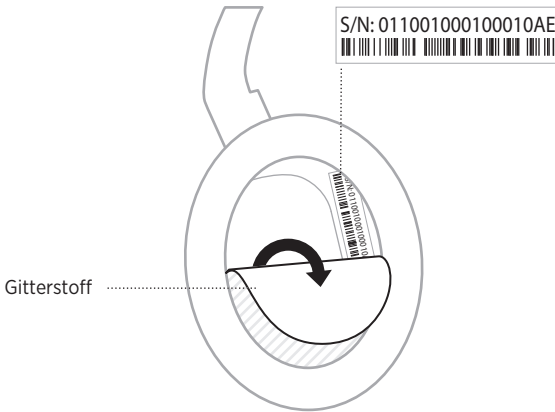

VERSUCHEN SIE ZUERST DIESE LÖSUNGEN

Bei Problemen mit den Kopfhörern:

- Prüfen Sie den Zustand der Statuslämpchen (siehe Seite 29).
- Laden Sie die Batterie auf (siehe Seite 28).
- Stellen Sie die Lautstärke an den Kopfhörern, am Mobilgerät und in der Music App höher.
- Laden Sie die Bose Music App herunter und führen Sie die verfügbaren Software-Updates aus (siehe Seite 14).
- Versuchen Sie, ein anderes Mobilgerät zu verbinden (siehe Seite 25).

Wenn Sie das Problem nicht beheben konnten, sehen Sie in der folgenden Tabelle nach, in der Sie Symptome und Lösungen für gängige Probleme finden. Wenn Sie Ihr Problem nicht beheben können, wenden Sie sich an den Bose-Kundendienst.

Besuchen Sie: worldwide.Bose.com/contact

ANDERE LÖSUNGEN

SYMPTOM	LÖSUNG
Die Kopfhörer schalten sich nicht ein	Laden Sie die Batterie auf.
Kopfhörer verbinden sich nicht mit dem Mobilgerät	<p>Trennen Sie das zusätzliche Audiokabel.</p> <p>Trennen Sie das USB-Ladekabel.</p> <p>Auf Ihrem Mobilgerät:</p> <p>Deaktivieren Sie die <i>Bluetooth</i>-Funktion und aktivieren Sie sie wieder.</p> <p>Löschen Sie die Bose QuietComfort 45-Kopfhörer aus der <i>Bluetooth</i>-Liste am Gerät, einschließlich aller doppelten Auflistungen mit der Bezeichnung LE (Low Energy). Stellen Sie die Verbindung erneut her.</p> <p>Stellen Sie das Mobilgerät näher zu den Kopfhörern und von Störquellen oder Hindernissen weg.</p> <p>Auf support.Bose.com/QCSE finden Sie Anleitungsvideos.</p> <p>Löschen Sie die Liste der verbundenen Geräte (siehe Seite 26) und verbinden Sie sich erneut.</p>
Batterie wird nicht aufgeladen	<p>Schließen Sie die Enden des USB-Ladekabels fest an.</p> <p>Versuchen Sie eine andere Ladequelle.</p> <p>Wenn die Kopfhörer hohen oder niedrigen Temperaturen ausgesetzt waren, lassen Sie die Kopfhörer Raumtemperatur annehmen und versuchen Sie das Aufladen erneut.</p>

SYMPTOM	LÖSUNG
Kein Ton	<p>Schalten Sie die Kopfhörer ein und laden Sie die Batterie.</p> <p>Prüfen Sie den Zustand der Statuslämpchen (siehe Seite 29).</p> <p>Schieben Sie den <i>Power/Bluetooth</i>-Schalter nach rechts und lassen Sie ihn los, um das verbundene Gerät zu hören. Stellen Sie sicher, dass Sie das richtige Gerät verwenden.</p> <p>Stellen Sie das Mobilgerät näher zu den Kopfhörern und von Störquellen oder Hindernissen weg.</p> <p>Verwenden Sie eine andere Musikquelle.</p> <p>Wenn zwei Mobilgeräte verbunden sind, halten Sie zuerst Ihr anderes Gerät an.</p> <p>Wenn zwei Mobilgeräte verbunden sind, stellen Sie die Geräte innerhalb der Reichweite der Kopfhörer (9 m) auf.</p> <p>Versuchen Sie eine lokal gespeicherte Musik- oder Videodatei auf Ihrem Mobilgerät.</p>
Schlechte Tonqualität	<p>Verwenden Sie eine andere Musikquelle.</p> <p>Verbinden Sie ein anderes Mobilgerät (siehe Seite 25).</p> <p>Trennen Sie das zweite Gerät.</p> <p>Stellen Sie das Mobilgerät näher zu den Kopfhörern und von Störquellen oder Hindernissen weg.</p> <p>Versuchen Sie eine lokal gespeicherte Musik- oder Videodatei auf Ihrem Mobilgerät.</p>
Keine Tonwiedergabe von einem per Audiokabel verbundenem Gerät	<p>Schließen Sie die Enden des zusätzlichen Audiokabels fest an.</p> <p>Stellen Sie die Lautstärke am Kopfhörer, auf Ihrem Mobilgerät und an der Musikquelle höher.</p> <p>Verbinden Sie ein anderes Gerät (siehe Seite 25).</p>
Schlechte Tonqualität von einem Gerät, das über Audiokabel verbunden ist	<p>Schließen Sie die Enden des zusätzlichen Audiokabels fest an.</p> <p>Verbinden Sie ein anderes Gerät (siehe Seite 25).</p>
Aktionstaste ändert den Geräuschunterdrückungsmodus nicht	<p>Stellen Sie sicher, dass die Kopfhörer eingeschaltet sind.</p> <p>Verwenden Sie die Bose Music App, um den Geräuschunterdrückungsmodus zu ändern.</p>

SYMPTOM	LÖSUNG
<p>Kopfhörer verbinden sich nicht mit einer Bose Smart Soundbar oder einen Bose Smart Speaker</p>	<p>Schieben und halten Sie den Power/<i>Bluetooth</i>-Schalter, bis Sie „Bereit zum Verbinden mit einem anderen Gerät“ hören und die <i>Bluetooth</i>-Anzeige blau blinkt.</p> <p>Vergewissern Sie sich, dass die Kopfhörer sich höchstens 9 m von der Soundbar oder dem Lautsprecher entfernt befinden.</p>
<p>Kopfhörer verbinden sich nicht erneut mit einer vorher verbundenen Bose Smart Soundbar oder einem vorher verbundenen Bose Smart Speaker</p>	<p>Verbinden Sie ein vorher verbundenes Gerät (siehe Seite 26).</p>
<p>Verzögerter Ton bei Verbindung mit einer Bose Smart Soundbar oder einem Bose Smart Speaker</p>	<p>Laden Sie die Bose Music App herunter und führen Sie die verfügbaren Software-Updates aus.</p>

Durch ein Wiederherstellen der werkseitigen Einstellungen werden alle Einstellungen gelöscht und die Kopfhörer sind wieder in ihrem Originalzustand. Danach können die Kopfhörer wie beim erstmaligen Einrichten konfiguriert werden.

Das Wiederherstellen der werkseitigen Einstellungen wird nur empfohlen, wenn Sie Probleme mit den Kopfhörern haben oder wenn Sie vom Bose Kundendienst angewiesen wurden, dies zu tun.

WIEDERHERSTELLEN DER WERKSEITIGEN EINSTELLUNGEN DER KOPFHÖRER

1. Entfernen Sie die Kopfhörer aus der *Bluetooth*-Liste am Gerät.
2. Entfernen Sie die Kopfhörer mithilfe der Bose Music App aus Ihrem Bose-Konto.

HINWEIS: Weitere Informationen darüber, wie Sie die Kopfhörer mithilfe der Bose Music App aus Ihrem Bose-Konto entfernen, finden Sie auf: support.Bose.com/QCSE

3. Schieben Sie den *Power/Bluetooth*-Schalter nach rechts \rightarrow und halten Sie ihn. Halten Sie gleichzeitig die Aktionstaste 30 Sekunden lang gedrückt.

Das Statuslämpchen blinkt weiß. Nach 30 Sekunden blinkt das Statuslämpchen gelb, um anzugeben, dass die werkseitigen Einstellungen wiederhergestellt wurden (2 bis 3 Sekunden lang).

4. Wenn das Wiederherstellen abgeschlossen ist, blinkt das Statuslämpchen langsam blau. Die Kopfhörer befinden sich jetzt in ihrem Originalzustand.

Lees alle veiligheids- en beveiligingsinstructies en de gebruiksaanwijzing door en bewaar deze.

CE Bose Corporation verklaart hierbij dat dit product voldoet aan de essentiële vereisten en andere relevante bepalingen van richtlijn 2014/53/EU en alle andere vereisten van de toepasselijke EU-richtlijnen. De volledige conformiteitsverklaring kunt u vinden op: www.Bose.com/compliance

UK CA Dit product voldoet aan alle toepasselijke voorschriften in de Electromagnetic Compatibility Regulations 2016 en aan alle overige toepasselijke wet- en regelgeving van het Verenigd Koninkrijk. De volledige conformiteitsverklaring kunt u vinden op: www.Bose.com/compliance

Bose Corporation verklaart hierbij dat dit product voldoet aan de essentiële vereisten zoals vastgelegd in de Radio Equipment Regulations 2017 en alle overige toepasselijke wet- en regelgeving van het Verenigd Koninkrijk. De volledige conformiteitsverklaring kunt u vinden op: www.Bose.com/compliance

Belangrijke veiligheidsinstructies

Gebruik dit apparaat niet in de buurt van water.

Alleen met een droge doek schoonmaken.

Laat alle onderhoud over aan bevoegde medewerkers. Onderhoud is vereist als het apparaat is beschadigd, als bijvoorbeeld een elektriciteitsnoer of stekker is beschadigd, als er vloeistof in het apparaat is gemorst of voorwerpen in het apparaat zijn gevallen, als het apparaat is blootgesteld aan regen of vocht, of als het niet normaal werkt of is gevallen.

WAARSCHUWINGEN

- Gebruik de hoofdtelefoon NIET gedurende lange tijd bij een hoog volume.
 - Om gehoorschade te voorkomen, dient u de hoofdtelefoon op een comfortabel, matig volume te gebruiken.
 - Zet het volume lager op uw apparaat voordat u de hoofdtelefoon in/op uw oren plaatst en zet het volume vervolgens geleidelijk hoger totdat u een comfortabel luistervolume bereikt.
- Gebruik de hoofdtelefoon NIET voor telefoongesprekken of andere doeleinden terwijl u rijdt.
- Gebruik de hoofdtelefoon NIET met noise cancelling ingeschakeld wanneer het niet kunnen horen van omgevingsgeluiden een gevaar voor uzelf of anderen kan opleveren, bijvoorbeeld tijdens fietsen of wandelen in of bij verkeer, een bouwterrein of spoorweg, enz. en houd u aan de toepasselijke wetgeving met betrekking tot het gebruik van hoofdtelefoons.
 - Zet de hoofdtelefoon uit of gebruik de hoofdtelefoon met noise cancelling uitgeschakeld en pas het volume aan om te zorgen dat u omgevingsgeluiden kunt horen, waaronder alarmen en waarschuwingssignalen.
 - Houd er rekening mee dat geluiden waarop u vertrouwt als herinnering of waarschuwing anders kunnen klinken wanneer u de hoofdtelefoon gebruikt, zelfs bij gebruik van de modus Geen NC.
- Gebruik de hoofdtelefoon NIET als deze een hard, ongewoon geluid te horen geeft. Als dit gebeurt, zet de hoofdtelefoon dan uit en neem contact op met de Bose-klantenservice.
- Zet de hoofdtelefoon onmiddellijk af als u warmte voelt of als het geluid wegvalt.
- Gebruik GEEN adapters van mobiele telefoons om hoofdtelefoons aan te sluiten op aansluitingen in vliegtuigstoelen aangezien dit kan leiden tot persoonlijk letsel of schade aan eigendommen door oververhitting.
- Gebruik de hoofdtelefoon NIET voor luchtvaartcommunicatie.



Bevat kleine onderdelen die een verstikkingsgevaar kunnen vormen. Niet geschikt voor kinderen jonger dan 3 jaar.



Dit product bevat magnetisch materiaal. Raadpleeg uw arts om te vragen of dit invloed kan hebben op uw implanteerbare medische hulpmiddel.

- Om het risico op brand of elektrische schokken te beperken, mag dit product NIET worden blootgesteld aan regen, vocht of druipende of spattende vloeistoffen en mogen er geen met vloeistof gevulde voorwerpen, zoals vazen, op of bij het product worden geplaatst.
- Houd het product uit de buurt van vuur en warmtebronnen. Plaats GEEN open vlammen, zoals brandende kaarsen, op of bij het product.
- Dit product mag alleen worden gebruikt met een officieel goedgekeurde LPS-voeding (Limited Power Supply) die voldoet aan de plaatselijke voorschriften (bv. UL, CSA, VDE, CCC).
- Er mogen GEEN wijzigingen aan dit product worden aangebracht door onbevoegden.
- Als de accu lekt, zorg dan dat de vloeistof niet in aanraking komt met huid of ogen. Bij aanraking dient u medische hulp in te roepen.
- Producten die accu's of batterijen bevatten niet blootstellen aan overmatige warmte (zoals direct zonlicht, vuur en dergelijke).
- Draag het product NIET tijdens het opladen.

OPMERKING: Dit apparaat is getest en voldoet aan de normen voor een digitaal apparaat van klasse B, volgens deel 15 van de FCC-voorschriften. Deze normen zijn bedoeld om redelijke bescherming te bieden tegen schadelijke storing bij installatie in een woonomgeving. Dit apparaat genereert en gebruikt radiofrequente energie en kan deze uitzenden en het kan, als het niet wordt geïnstalleerd en gebruikt volgens de instructies, schadelijke storing veroorzaken aan radiocommunicatie. Er is echter geen garantie dat er geen storing zal optreden bij een bepaalde installatie. Als dit apparaat schadelijke storing veroorzaakt aan de ontvangst van radio of tv, hetgeen kan worden bepaald door het apparaat aan en uit te zetten, wordt geadviseerd te trachten de storing te verhelpen door een of meer van de volgende maatregelen:

- Draai of verplaats het ontvangende product of de ontvangstantenne.
- Vergroot de afstand tussen de apparatuur en de ontvanger.
- Sluit de apparatuur aan op een stopcontact van een andere groep dan de groep waarop de ontvanger is aangesloten.
- Voor hulp neemt u contact op met de dealer of een ervaren radio- of tv-technicus.

Veranderingen of aanpassingen die niet uitdrukkelijk zijn goedgekeurd door Bose Corporation kunnen leiden tot het vervallen van de bevoegdheid van de gebruiker om dit apparaat te gebruiken.

Dit apparaat voldoet aan deel 15 van de FCC-voorschriften en aan de RSS-norm(en) van ISED Canada voor vergunningsvrije apparaten. Op het gebruik zijn de volgende twee voorwaarden van toepassing: (1) Dit apparaat mag geen schadelijke storing veroorzaken, en (2) dit apparaat moet bestand zijn tegen alle externe storing, waaronder storing die een ongewenste werking tot gevolg kan hebben.

Dit apparaat voldoet aan de limieten van de FCC en ISED Canada voor blootstelling van de bevolking aan straling. Deze zender mag niet worden geplaatst bij of samen worden gebruikt met een andere antenne of zender.

Voldoet aan de IMDA-vereisten.

FCC-ID: A94437310

IC: 3232A-437310

CAN ICES-3(B)/NMB-3(B)

Voor Europa:

Frequentieband 2400 tot 2483,5 MHz.

Maximaal zendvermogen minder dan 20 dBm EIRP.

Het maximaal zendvermogen blijft dusdanig onder de wettelijk vastgestelde limieten dat het product volgens de toepasselijke regelgeving geen SAR-toetsing behoeft en hiervan is vrijgesteld.



Dit symbool betekent dat het product niet mag worden weggegooid als huishoudelijk afval en naar een geschikt inzamelpunt voor recycling moet worden gebracht. Het op de juiste wijze afvoeren en recyclen helpt natuurlijke hulpbronnen, de menselijke gezondheid en het milieu te beschermen. Voor meer informatie over het afvoeren en recyclen van dit product neemt u contact op met de gemeente waar u woont, de afvalverwerkingsinstantie of de winkel waar u dit product hebt gekocht.

Technische voorschriften m.b.t. radiofrequente apparaten met laag vermogen

Zonder toestemming van de NCC mogen bedrijven, ondernemingen of gebruikers de oorspronkelijke eigenschappen en werking van goedgekeurde radiofrequente apparaten met laag vermogen niet wijzigen en evenmin de frequentie daarvan wijzigen of het zendvermogen verhogen. Radiofrequente apparaten met laag vermogen mogen de veiligheid van vliegtuigen niet beïnvloeden en wettelijke communicaties niet verstoren. Als een dergelijke storing wordt vastgesteld, moet de gebruiker onmiddellijk stoppen met het gebruik van het apparaat tot dit niet langer storing veroorzaakt. Onder de genoemde wettelijke communicaties wordt verstaan dat radiocommunicatie wordt gebruikt in overeenstemming met de Telecommunications Management Act (wet op telecommunicatiebeheer). Radiofrequente apparaten met laag vermogen moeten bestand zijn tegen storing van wettelijke communicaties of apparaten die ISM-radiogolven uitzenden.

Probeer **NIET** om de oplaadbare lithium-ion-accu uit dit product te verwijderen. Neem contact op met uw plaatselijke Bose-dealer of ander bevoegd vakman om deze te verwijderen.

De oplaadbare lithium-ion-accu in dit product mag alleen door een bevoegd vakman worden verwijderd. Voor verdere informatie neemt u contact op met uw plaatselijke Bose-verkoper of gaat u naar products.bose.com/static/compliance/index.html.



Gooi gebruikte accu's en batterijen op de juiste wijze weg, volgens de plaatselijke voorschriften.
Niet verbranden.



Namen van en gehalte aan giftige of gevaarlijke stoffen of elementen						
Naam onderdeel	Giftige of gevaarlijke stoffen en elementen					
	Lood (Pb)	Kwik (Hg)	Cadmium (Cd)	Zeswaardig chroom (Cr(VI))	Polybroomdifenyylether (PBB)	Polybroomdifenyylether (PBDE)
PCB's	X	0	0	0	0	0
Metalen onderdelen	X	0	0	0	0	0
Plastic onderdelen	0	0	0	0	0	0
Luidspreker	X	0	0	0	0	0
Kabels	X	0	0	0	0	0
Deze tabel is opgesteld in overeenstemming met de bepalingen van SJ/T 11364. O: Geeft aan dat het gehalte aan deze giftige of gevaarlijke stof in alle homogene materialen van dit onderdeel onder de maximaal toegelaten waarden in GB/T 26572 ligt. X: Geeft aan dat de giftige of gevaarlijke stof in minstens één van de voor dit onderdeel gebruikte homogene materialen boven de maximaal toegelaten waarden in GB/T 26572 ligt.						

Fabricagedatum: Het achtste cijfer in het serienummer geeft het fabricagejaar aan. "2" is 2012 of 2022.

Importeur in China: Bose Electronics (Shanghai) Company Limited, Level 6, Tower D, No. 2337 Gudai Rd. Minhang District, Shanghai 201100

Importeur in de EU: Bose Products B.V., Gorslaan 60, 1441 RG Purmerend, Nederland

Importeur in Mexico: Bose de México S. de R.L. de C.V., Avenida Prado Sur #150, Piso 2, Interior 222 y 223, Colonia Lomas de Chapultepec V Sección, Miguel Hidalgo, Ciudad de México, C.P. 11000 Telefoonnummer: +5255 (5202) 3545

Importeur in Taiwan: Bose Limited Taiwan Branch (H.K.), 9F., No. 10, Sec. 3, Minsheng E. Road, Zhongshan Dist. Taipei City 10480, Taiwan Telefoonnummer: +886-2-2514 7676

Importeur in het VK: Bose Limited, Bose House, Quayside Chatham Maritime, Chatham, Kent, ME4 4QZ, United Kingdom

Ingangsspecificaties: 5 V --- 0,5 A

Oplaattemperatuur: 0 °C tot 45 °C

Ontlaadtemperatuur: -20 °C tot 60 °C

Model 437310. De CMIIT-ID bevindt zich in de oorschelp onder de afscherming.

Vul het volgende in en bewaar deze informatie voor uw administratie

De serie- en modelnummers bevinden zich in de oorschelp onder de afscherming.

Serienummer: _____

Modelnummer: _____

Bewaar uw betalingsbewijs samen met de gebruikershandleiding. Dit is een goed moment om uw Bose-product te registreren. Dit kan eenvoudig door naar worldwide.Bose.com/ProductRegistration te gaan.

Beveiligingsinformatie



Dit product kan automatische beveiligingsupdates van Bose ontvangen wanneer het is verbonden met de Bose Music-app. Om via de mobiele applicatie beveiligingsupdates te ontvangen, dient u de productinstallatieprocedure in de Bose Music-app te voltooien. **Als u de installatieprocedure niet voltooit, bent u zelf verantwoordelijk voor het installeren van de beveiligingsupdates die Bose ter beschikking stelt via btu.bose.com**

Apple, het Apple-logo, iPad, iPhone en iPod zijn handelsmerken van Apple Inc., gedeponeerd in de VS en andere landen. App Store is een servicemerk van Apple Inc. Het handelsmerk "iPhone" wordt in Japan gebruikt met een licentie van Aiphone K.K.

Gebruik van de Made for Apple-badge betekent dat een accessoire speciaal ontworpen is voor verbinding met de in de badge vermelde Apple-producten en is gecertificeerd door de ontwikkelaar om te voldoen aan de prestatiestandaarden van Apple. Apple is niet verantwoordelijk voor de werking van dit apparaat of de mate waarin het apparaat voldoet aan veiligheidsnormen en wettelijke voorschriften.

Het *Bluetooth*[®]-woordmerk en de bijbehorende logo's zijn gedeponeerde handelsmerken die het eigendom zijn van Bluetooth SIG, Inc. en het gebruik van dergelijke merken door Bose Corporation gebeurt onder licentie.

Google Play is een handelsmerk van Google LLC.

USB Type-C[®] and USB-C[®] zijn gedeponeerde handelsmerken van USB Implementers Forum.

Bose, Bose Home Speaker, Bose Music, het Bose Music-logo, Bose Smart Soundbar, Bose Smart Speaker, Bose Soundbar, QuietComfort en SimpleSync zijn handelsmerken van Bose Corporation.

Hoofdkantoor Bose Corporation: 1-877-230-5639

©2022 Bose Corporation. Niets in deze uitgave mag worden gereproduceerd, gewijzigd, gedistribueerd of op andere wijze gebruikt zonder voorafgaande schriftelijke toestemming.

The following license disclosures apply to certain third-party software packages used as components in the product.

Package: FreeRTOS

Copyright © Amazon Web Services, Inc. or its affiliates. All rights reserved.

The FreeRTOS package is subject to the license terms reprinted below:

MIT License

Permission is hereby granted, free of charge, to any person obtaining a copy of this software and associated documentation files (the “Software”), to deal in the Software without restriction, including without limitation the rights to use, copy, modify, merge, publish, distribute, sublicense, and/or sell copies of the Software, and to permit persons to whom the Software is furnished to do so, subject to the following conditions:

The above copyright notice and this permission notice shall be included in all copies or substantial portions of the Software.

THE SOFTWARE IS PROVIDED “AS IS”, WITHOUT WARRANTY OF ANY KIND, EXPRESS OR IMPLIED, INCLUDING BUT NOT LIMITED TO THE WARRANTIES OF MERCHANTABILITY, FITNESS FOR A PARTICULAR PURPOSE AND NONINFRINGEMENT. IN NO EVENT SHALL THE AUTHORS OR COPYRIGHT HOLDERS BE LIABLE FOR ANY CLAIM, DAMAGES OR OTHER LIABILITY, WHETHER IN AN ACTION OF CONTRACT, TORT OR OTHERWISE, ARISING FROM, OUT OF OR IN CONNECTION WITH THE SOFTWARE OR THE USE OR OTHER DEALINGS IN THE SOFTWARE.

Package: Nanopb

Copyright © 2011 Petteri Aimonen <jpa at nanopb.mail.kapsi.fi>.

The Nanopb package is subject to the license terms reprinted below:

Zlib License

© 2011 Petteri Aimonen <jpa at nanopb.mail.kapsi.fi>

This software is provided ‘as-is’, without any express or implied warranty. In no event will the authors be held liable for any damages arising from the use of this software.

Permission is granted to anyone to use this software for any purpose, including commercial applications, and to alter it and redistribute it freely, subject to the following restrictions:

1. The origin of this software must not be misrepresented; you must not claim that you wrote the original software. If you use this software in a product, an acknowledgment in the product documentation would be appreciated but is not required.
2. Altered source versions must be plainly marked as such, and must not be misrepresented as being the original software.
3. This notice may not be removed or altered from any source distribution.

Package: Mbed TLS 2.16.1

© ARM Limited. All rights reserved.

The Mbed TLS package is subject to the license terms reprinted below:

Apache License

Version 2.0, January 2004

<http://www.apache.org/licenses/>

TERMS AND CONDITIONS FOR USE, REPRODUCTION, AND DISTRIBUTION

1. Definitions.
“License” shall mean the terms and conditions for use, reproduction, and distribution as defined by Sections 1 through 9 of this document.

“Licensor” shall mean the copyright owner or entity authorized by the copyright owner that is granting the License.

“Legal Entity” shall mean the union of the acting entity and all other entities that control, are controlled by, or are under common control with that entity. For the purposes of this definition, “control” means (i) the power, direct or indirect, to cause the direction or management of such entity, whether by contract or otherwise, or (ii) ownership of fifty percent (50%) or more of the outstanding shares, or (iii) beneficial ownership of such entity.

“You” (or “Your”) shall mean an individual or Legal Entity exercising permissions granted by this License.

“Source” form shall mean the preferred form for making modifications, including but not limited to software source code, documentation source, and configuration files.

“Object” form shall mean any form resulting from mechanical transformation or translation of a Source form, including but not limited to compiled object code, generated documentation, and conversions to other media types.

“Work” shall mean the work of authorship, whether in Source or Object form, made available under the License, as indicated by a copyright notice that is included in or attached to the work (an example is provided in the Appendix below).

“Derivative Works” shall mean any work, whether in Source or Object form, that is based on (or derived from) the Work and for which the editorial revisions, annotations, elaborations, or other modifications represent, as a whole, an original work of authorship. For the purposes of this License, Derivative Works shall not include works that remain separable from, or merely link (or bind by name) to the interfaces of, the Work and Derivative Works thereof.

“Contribution” shall mean any work of authorship, including the original version of the Work and any modifications or additions to that Work or Derivative Works thereof, that is intentionally submitted to Licensor for inclusion in the Work by the copyright owner or by an individual or Legal Entity authorized to submit on behalf of the copyright owner. For the purposes of this definition, “submitted” means any form of electronic, verbal, or written communication sent to the Licensor or its representatives, including but not limited to communication on electronic mailing lists, source code control systems, and issue tracking systems that are managed by, or on behalf of, the Licensor for the purpose of discussing and improving the Work, but excluding communication that is conspicuously marked or otherwise designated in writing by the copyright owner as “Not a Contribution.”

“Contributor” shall mean Licensor and any individual or Legal Entity on behalf of whom a Contribution has been received by Licensor and subsequently incorporated within the Work.

2. Grant of Copyright License. Subject to the terms and conditions of this License, each Contributor hereby grants to You a perpetual, worldwide, non-exclusive, no-charge, royalty-free, irrevocable copyright license to reproduce, prepare Derivative Works of, publicly display, publicly perform, sublicense, and distribute the Work and such Derivative Works in Source or Object form.
3. Grant of Patent License. Subject to the terms and conditions of this License, each Contributor hereby grants to You a perpetual, worldwide, non-exclusive, no-charge, royalty-free, irrevocable (except as stated in this section) patent license to make, have made, use, offer to sell, sell, import, and otherwise transfer the Work, where such license applies only to those patent claims licensable by such Contributor that are necessarily infringed by their Contribution(s) alone or by combination of their Contribution(s) with the Work to which such Contribution(s) was submitted. If You institute patent litigation against any entity (including a cross-claim or counterclaim in a lawsuit) alleging that the Work or a Contribution incorporated within the Work constitutes direct or contributory patent infringement, then any patent licenses granted to You under this License for that Work shall terminate as of the date such litigation is filed.
4. Redistribution. You may reproduce and distribute copies of the Work or Derivative Works thereof in any medium, with or without modifications, and in Source or Object form, provided that You meet the following conditions:
 - a. You must give any other recipients of the Work or Derivative Works a copy of this License; and
 - b. You must cause any modified files to carry prominent notices stating that You changed the files; and
 - c. You must retain, in the Source form of any Derivative Works that You distribute, all copyright, patent, trademark, and attribution notices from the Source form of the Work, excluding those notices that do not pertain to any part of the Derivative Works; and

d. If the Work includes a “NOTICE” text file as part of its distribution, then any Derivative Works that You distribute must include a readable copy of the attribution notices contained within such NOTICE file, excluding those notices that do not pertain to any part of the Derivative Works, in at least one of the following places: within a NOTICE text file distributed as part of the Derivative Works; within the Source form or documentation, if provided along with the Derivative Works; or, within a display generated by the Derivative Works, if and wherever such third-party notices normally appear. The contents of the NOTICE file are for informational purposes only and do not modify the License. You may add Your own attribution notices within Derivative Works that You distribute, alongside or as an addendum to the NOTICE text from the Work, provided that such additional attribution notices cannot be construed as modifying the License.

You may add Your own copyright statement to Your modifications and may provide additional or different license terms and conditions for use, reproduction, or distribution of Your modifications, or for any such Derivative Works as a whole, provided Your use, reproduction, and distribution of the Work otherwise complies with the conditions stated in this License.

5. Submission of Contributions. Unless You explicitly state otherwise, any Contribution intentionally submitted for inclusion in the Work by You to the Licensor shall be under the terms and conditions of this License, without any additional terms or conditions. Notwithstanding the above, nothing herein shall supersede or modify the terms of any separate license agreement you may have executed with Licensor regarding such Contributions.
6. Trademarks. This License does not grant permission to use the trade names, trademarks, service marks, or product names of the Licensor, except as required for reasonable and customary use in describing the origin of the Work and reproducing the content of the NOTICE file.
7. Disclaimer of Warranty. Unless required by applicable law or agreed to in writing, Licensor provides the Work (and each Contributor provides its Contributions) on an “AS IS” BASIS, WITHOUT WARRANTIES OR CONDITIONS OF ANY KIND, either express or implied, including, without limitation, any warranties or conditions of TITLE, NON-INFRINGEMENT, MERCHANTABILITY, or FITNESS FOR A PARTICULAR PURPOSE. You are solely responsible for determining the appropriateness of using or redistributing the Work and assume any risks associated with Your exercise of permissions under this License.
8. Limitation of Liability. In no event and under no legal theory, whether in tort (including negligence), contract, or otherwise, unless required by applicable law (such as deliberate and grossly negligent acts) or agreed to in writing, shall any Contributor be liable to You for damages, including any direct, indirect, special, incidental, or consequential damages of any character arising as a result of this License or out of the use or inability to use the Work (including but not limited to damages for loss of goodwill, work stoppage, computer failure or malfunction, or any and all other commercial damages or losses), even if such Contributor has been advised of the possibility of such damages.
9. Accepting Warranty or Additional Liability. While redistributing the Work or Derivative Works thereof, You may choose to offer, and charge a fee for, acceptance of support, warranty, indemnity, or other liability obligations and/or rights consistent with this License. However, in accepting such obligations, You may act only on Your own behalf and on Your sole responsibility, not on behalf of any other Contributor, and only if You agree to indemnify, defend, and hold each Contributor harmless for any liability incurred by, or claims asserted against, such Contributor by reason of your accepting any such warranty or additional liability.

END OF TERMS AND CONDITIONS

©2022 Bose Corporation

Licensed under the Apache License, Version 2.0 (the “License”); you may not use this file except in compliance with the License.

You may obtain a copy of the License at: <http://www.apache.org/licenses/LICENSE-2.0>

Unless required by applicable law or agreed to in writing, software distributed under the License is distributed on an “AS IS” BASIS, WITHOUT WARRANTIES OR CONDITIONS OF ANY KIND, either express or implied.

See the License for the specific language governing permissions and limitations under the License.

INHOUD VAN DE DOOS

Inhoud 13

BOSE MUSIC-APP

De Bose Music-app downloaden 14
 De hoofdtelefoon toevoegen aan een bestaand account 14

BEDIENING VAN DE HOOFDTELEFOON

Inschakelen 16
 Stand-bytimer 16
 Uitschakelen 17
 Functies van de hoofdtelefoon 18
 Afspelen en volume regelen 18
 Telefonische oproepen 19
 Actie-knop 20

NOISE CANCELLING

Noise cancelling-modi 21
 De noise cancelling-modus wijzigen 21

SPRAAKBEDIENING

Spraakbediening activeren 22

BLUETOOTH®-VERBINDINGEN

Verbinden via het *Bluetooth*-menu op uw mobiele apparaat 23
 De verbinding met een mobiel apparaat verbreken 25
 Een mobiel apparaat opnieuw verbinden 25
 Verbinden met nog een mobiel apparaat 25
 Verbonden mobiele apparaten identificeren 25
 Schakelen tussen twee verbonden mobiele apparaten 25
 Opnieuw verbinden met een eerder verbonden apparaat 26
 De lijst met apparaten van de hoofdtelefoon wissen 26

BEDRADE AANSLUITINGEN

De audiokabel aansluiten..... 27

ACCU

De hoofdtelefoon opladen..... 28
 Oplaadtijd 28
 Het laadniveau van de accu horen..... 28

STATUS VAN DE HOOFDTELEFOON

Bluetooth-status 29
 Accustatus 29
 Oplaadstatus 30
 Update- en foutstatus 30

BOSE-PRODUCTEN VERBINDEN

Een Bose Smart Speaker of Soundbar verbinden 31
 Voordelen..... 31
 Compatibele producten 31
 Verbinden via de Bose Music-app..... 31
 Opnieuw verbinden met een Bose Smart Speaker of Soundbar 32

VERZORGING EN ONDERHOUD

De hoofdtelefoon opbergen..... 33
 De hoofdtelefoon schoonmaken 34
 Reserveonderdelen en accessoires..... 34
 Beperkte garantie 34
 Plaats van het serienummer 35

PROBLEMEN OPLOSSEN

Probeer deze oplossingen eerst 36

Andere oplossingen 36

De fabrieksinstellingen van de hoofdtelefoon terugzetten..... 39

INHOUD

Controleer of de volgende onderdelen aanwezig zijn:



Bose QuietComfort 45 headphones

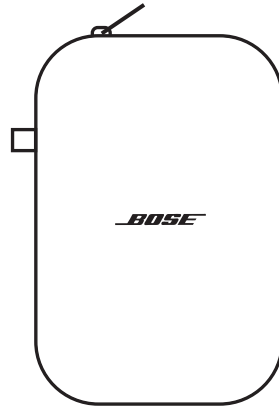

Zacht draagetui

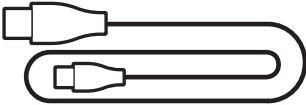

USB Type-C®-kabel

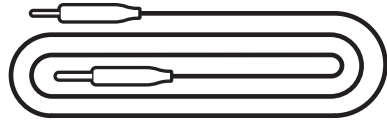

3,5 mm-naar-2,5 mm-audiokabel

OPMERKING: Als een deel van het product beschadigd is, mag u het niet gebruiken. Neem contact op met een erkende Bose-dealer of de Bose-klantenservice.

Ga naar: support.Bose.com/QCSE

Met de Bose Music-app kunt u de hoofdtelefoon instellen en bedienen via een mobiel apparaat, zoals een smartphone of tablet.

U kunt via de app *Bluetooth*-verbindingen beheren, de instellingen voor de hoofdtelefoon aanpassen, de taal voor de gesproken mededelingen kiezen en door middel van updates nieuwe functies ophalen.

OPMERKING: Als u voor een ander Bose-product al een Bose Music-account hebt aangemaakt, voeg de hoofdtelefoon dan toe aan uw bestaande account (zie pagina 14 onderaan).

DE BOSE MUSIC-APP DOWNLOADEN

1. Download de Bose Music-app op uw mobiele apparaat.



2. Volg de instructies van de app.

DE HOOFDTELEFOON TOEVOEGEN AAN EEN BESTAAND ACCOUNT

Om uw Bose QuietComfort 45 headphones toe te voegen, opent u de Bose Music-app en voegt u uw hoofdtelefoon toe.

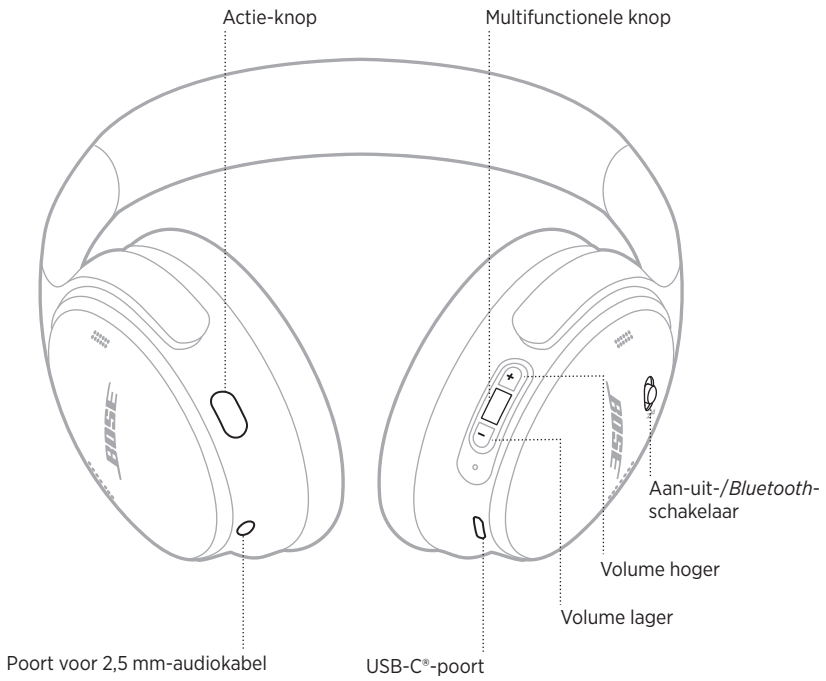

INSCHAKELEN

Schuif de aan-uit-/*Bluetooth*-schakelaar op de rechteroorschelp naar rechts.

Een gesproken mededeling meldt het accuniveau en het statuslampje geeft het huidige laadniveau aan (zie pagina 29).



Stand-bytimer

De stand-bytimer spaart de accu wanneer de hoofdtelefoon niet wordt gebruikt.

Gebruik de Bose Music-app om de stand-bytimer in te stellen en aan te passen.

UITSCHAKELEN

Schuif de aan-uit-/*Bluetooth*-schakelaar naar links.



OPMERKING: Wanneer de hoofdtelefoon wordt uitgeschakeld, wordt ook de noise cancelling uitgeschakeld.

FUNCTIES VAN DE HOOFDTELEFOON

De knoppen op de hoofdtelefoon bevinden zich aan de achterkant van de rechteroorschelp.

Afspelen en volume regelen

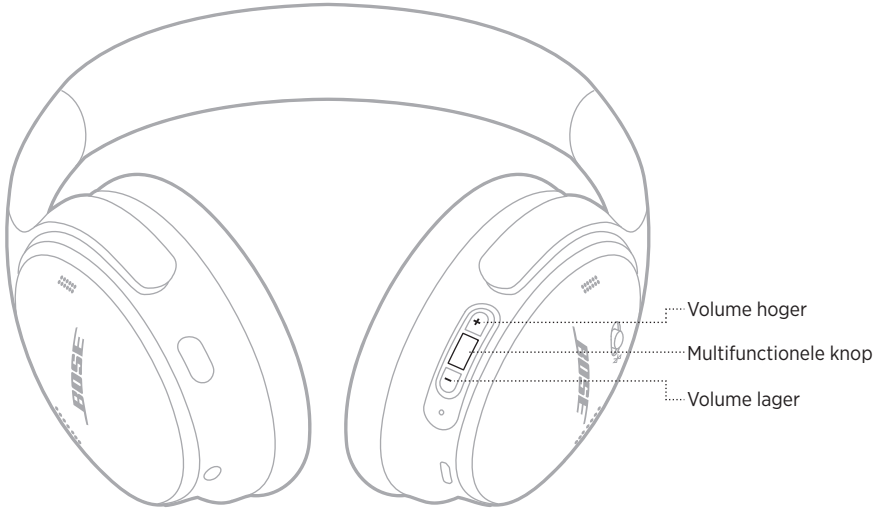

FUNCTIE	WAT TE DOEN
Afspelen/Pauzeren	Druk op de multifunctionele knop.
Vooruit skippen	Druk tweemaal op de multifunctionele knop.
Achteruit skippen	Druk driemaal op de multifunctionele knop.
Volume hoger	Druk op +.
Volume lager	Druk op –.

OPMERKINGEN:

- Om het volume snel hoger te zetten, houdt u + ingedrukt.
- Om het volume snel lager te zetten, houdt u – ingedrukt.

Telefonische oproepen

De multifunctionele knop bevindt zich aan de achterkant van de rechteroorschelp.
De microfoon bevindt zich aan de voorkant van de rechteroorschelp.

De Actie-knop bevindt zich aan de achterkant van de linkeroorschelp.

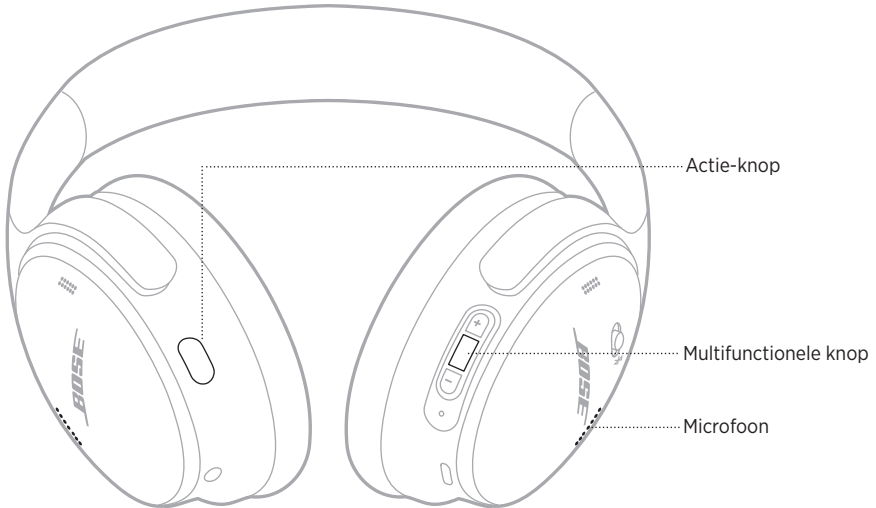

FUNCTIE	WAT TE DOEN
Een oproep beantwoorden of beëindigen	Druk op de multifunctionele knop.
Een inkomende oproep weigeren	Houd de multifunctionele knop 1 seconde ingedrukt.
Een tweede inkomende oproep beantwoorden en de huidige oproep in de wacht zetten	Wanneer er tijdens een oproep een tweede oproep binnenkomt, drukt u op de multifunctionele knop.
Een tweede inkomende oproep weigeren en doorgaan met de huidige oproep	Wanneer er tijdens een oproep een tweede oproep binnenkomt, houdt u de multifunctionele knop 1 seconde ingedrukt.
Schakelen tussen twee oproepen	Druk bij twee actieve oproepen tweemaal op de multifunctionele knop.
Een telefonische vergadering starten	Houd bij twee actieve oproepen de multifunctionele knop 3 seconden ingedrukt.
Het geluid van een oproep in-/uitschakelen	Druk tijdens een oproep op de Actie-knop.

Actie-knop

Met de Actie-knop kunt u snel en gemakkelijk schakelen tussen noise cancelling-modi.

De Actie-knop bevindt zich aan de achterkant van de linkeroorschelp.

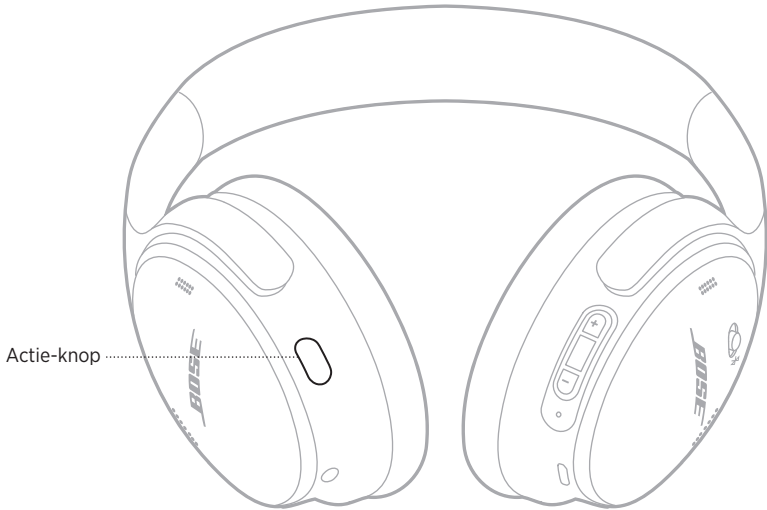

Druk op de Actie-knop om te schakelen tussen de modus Stil en de modus Geen NC.

Voor meer informatie over noise cancelling-modi, zie pagina 21.

Noise cancelling vermindert ongewenst omgevingsgeluid, waardoor het afspelen helderder en natuurgetrouwer klinkt. U kunt kiezen tussen twee noise cancelling-modi: Stil en Geen NC.

In de stille modus wordt het hoogste noise cancelling-niveau gebruikt, zodat u storende geluiden kunt buitensluiten.

De modus Geen NC biedt volledige transparantie, zodat u uw omgeving blijft horen terwijl u naar uw audio luistert.

Kies uw noise cancelling-modus op basis van uw luistervoorkeuren en omgeving.

NOISE CANCELLING-MODI

MODUS	OMSCHRIJVING
Stil	Eersteklas noise cancelling met door Bose geoptimaliseerde audio.
Geen NC	Blijf uw omgeving horen terwijl u naar uw audio luistert.

OPMERKING: Wanneer de hoofdtelefoon wordt ingeschakeld, is deze standaard ingesteld op de laatst gebruikte modus.

DE NOISE CANCELLING-MODUS WIJZIGEN

Druk op de Actie-knop om de noise cancelling-modus te wijzigen.

Een gesproken mededeling meldt de geselecteerde noise cancelling-modus.

TIP: U kunt de noise cancelling-modus ook wijzigen met de Bose Music-app.

SPRAAKBEDIENING ACTIVEREN

U kunt de hoofdtelefoon gebruiken om spraakbediening op uw mobiele apparaat te activeren. Houd de multifunctionele knop 1 seconde ingedrukt om spraakbediening te activeren.

De multifunctionele knop bevindt zich aan de achterkant van de rechterschelp.

OPMERKING: U hebt geen toegang tot spraakbediening terwijl u aan het bellen bent.

VERBINDEN VIA HET *BLUETOOTH*-MENU OP UW MOBIELE APPARAAT

U kunt maximaal acht apparaten in de lijst met apparaten van de hoofdtelefoon opslaan en de hoofdtelefoon kan met twee apparaten tegelijk actief verbonden zijn. U kunt van slechts één apparaat tegelijk audio afspelen.

OPMERKING: Voor het beste resultaat gebruikt u de Bose Music-app om uw mobiele apparaat in te stellen en te verbinden (zie pagina 14).

1. Schuif de aan-uit-/*Bluetooth*-schakelaar naar rechts \rightarrow en houd deze daar 3 seconden vast.

U hoort "Klaar om te verbinden" en het statuslampje knippert blauw.



2. Schakel de *Bluetooth*-functie op uw apparaat in.

OPMERKING: De *Bluetooth*-functie bevindt zich meestal in het menu Instellingen.

3. Selecteer de hoofdtelefoon in de lijst met apparaten.

TIP: Zoek de naam die u in de Bose Music-app voor de hoofdtelefoon hebt ingevoerd. Als u de hoofdtelefoon geen naam hebt gegeven, verschijnt de standaardnaam.



Zodra de verbinding tot stand is gebracht, hoort u “Verbonden met <naam apparaat>” en brandt het statuslampje 10 seconden continu blauw.

DE VERBINDING MET EEN MOBIEL APPARAAT VERBREKEN

Gebruik de Bose Music-app om de verbinding met uw mobiele apparaat te verbreken.

TIP: U kunt de verbinding ook verbreken via de *Bluetooth*-instellingen. Als u de *Bluetooth*-functie uitschakelt, worden ook alle verbindingen met andere apparaten verbroken.

EEN MOBIEL APPARAAT OPNIEUW VERBINDEN

Als de hoofdtelefoon wordt ingeschakeld, wordt geprobeerd opnieuw verbinding te maken met de twee laatst verbonden mobiele apparaten.

OPMERKINGEN:

- Het apparaat moet zich binnen het bereik bevinden (9 m) en ingeschakeld zijn.
- Zorg dat de *Bluetooth*-functie op uw mobiele apparaat is ingeschakeld.

VERBINDEN MET NOG EEN MOBIEL APPARAAT

Als u verbinding wilt maken met nog een apparaat, downloadt u de Bose Music-app (zie pagina 14) of gebruikt u het *Bluetooth*-menu op uw mobiele apparaat (zie pagina 23).

OPMERKING: U kunt slechts van één apparaat tegelijk audio afspelen.

VERBONDEN MOBIELE APPARATEN IDENTIFICEREN

Schuif de aan-uit-/*Bluetooth*-schakelaar naar rechts ⌘ en laat deze los om te horen welk apparaat momenteel verbonden is.

SCHAKELEN TUSSEN TWEE VERBONDEN MOBIELE APPARATEN

1. Pauzeer de audio op het eerste mobiele apparaat.
2. Speel audio af op het tweede mobiele apparaat.

OPMERKING: De hoofdtelefoon kan oproepen ontvangen van beide apparaten, ongeacht welk apparaat audio afspeelt.

OPNIEUW VERBINDEN MET EEN EERDER VERBODEN APPARAAT

1. Schuif de aan-uit-/*Bluetooth*-schakelaar naar rechts ☒ en laat deze los om te horen welk apparaat verbonden is.
2. Schuif de aan-uit-/*Bluetooth*-schakelaar binnen 2 seconden naar rechts ☒ en laat deze weer los om verbinding te maken met het volgende apparaat in de lijst met apparaten van de hoofdtelefoon.
3. Herhaal dit totdat u de naam van het juiste apparaat hoort.
U hoort een toon die aangeeft wanneer het apparaat verbonden is.
4. Speel audio af op het verbonden mobiele apparaat.

OPMERKING: Als er al twee apparaten met de telefoon zijn verbonden, vervangt het zojuist verbonden apparaat het tweede eerder verbonden apparaat.

DE LIJST MET APPARATEN VAN DE HOOFDTELEFOON WISSEN

1. Schuif de aan-uit-/*Bluetooth*-schakelaar naar rechts ☒ en houd deze daar 15 seconden vast, totdat u “De lijst met *Bluetooth*-apparaten is gewist. Klaar om te verbinden” hoort.
2. Verwijder de hoofdtelefoon van de *Bluetooth*-lijst op uw mobiele apparaat.
Alle apparaten worden gewist en de hoofdtelefoon is klaar om te verbinden.

DE AUDIOKABEL AANSLUITEN

Gebruik de 2,5 mm-naar-3,5 mm-kabel om een niet-draadloos apparaat aan te sluiten of om de hoofdtelefoon te blijven gebruiken als de accu leeg is.

1. Sluit de kabel aan op de 2,5 mm-poort op de linkeroorschelp.



2. Sluit het andere uiteinde van de kabel aan op de 3,5 mm-poort op uw apparaat.

OPMERKING: U kunt de hoofdtelefoon zowel in- als uitgeschakeld gebruiken wanneer de audiokabel is aangesloten.

DE HOOFDTELEFOON OPLADEN

1. Sluit de kleine stekker van de USB-kabel aan op de USB-C-poort op de rechteroorschelp.
2. Sluit het andere uiteinde aan op een USB-wandoplader.



OPMERKINGEN:

- Wanneer de hoofdtelefoon begint met opladen, knippert het statuslampje 10 seconden wit. Wanneer de accu volledig opgeladen is, brandt het statuslampje continu wit.
- De hoofdtelefoon geeft tijdens het opladen geen geluid weer.

Oplaadtijd

Het duurt maximaal 2,5 uur om de hoofdtelefoon volledig op te laden.

Het laadniveau van de accu horen

Wanneer u de hoofdtelefoon inschakelt, hoort u een gesproken mededeling met het accuniveau. Als de accu van de hoofdtelefoon bijna leeg is, hoort u “Accu bijna leeg, nu opladen.”

OPMERKING: U kunt het accuniveau ook zien aan het statuslampje op de rechteroorschelp. Voor meer informatie, zie “Accustatus” op pagina 29.

Het statuslampje bevindt zich op de rechteroorschelp.



BLUETOOTH-STATUS

Toont de *Bluetooth*-verbindingstatus.

ACTIVITEIT VAN HET LAMPJE	SYSTEEMSTATUS
Knipperend blauw	Klaar om te verbinden
Continu blauw (10 seconden)	Verbonden

ACCUSTATUS

Dit geeft het accuniveau aan.

ACTIVITEIT VAN HET LAMPJE	SYSTEEMSTATUS
Continu wit	Half tot volledig opgeladen
Continu oranje	Bijna leeg

TIP: U kunt het accuniveau ook controleren via de Bose Music-app.

OPLAADSTATUS

Toont de oplaadstatus.

ACTIVITEIT VAN HET LAMPJE	SYSTEEMSTATUS
Knippert 2 keer wit	Begint met opladen
Continu oranje	Bezig met opladen
Continu wit	Volledig opgeladen

UPDATE- EN FOUTSTATUS

Toont de updatestatus of de foutstatus.

ACTIVITEIT VAN HET LAMPJE	SYSTEEMSTATUS
Knippert snel wit (10 seconden)	Bezig met software-update (via USB)
Knippert langzaam wit (30 tot 60 seconden)	Bezig met software-update (draadloos)
Knippert oranje en wit	Fout - neem contact op met de Bose-klantenservice

EEN BOSE SMART SPEAKER OF SOUNDBAR VERBINDEN

Met de SimpleSync™-technologie kunt u de hoofdtelefoon verbinden met een Bose Smart Soundbar of Bose Smart Speaker voor een persoonlijke luisterervaring.

Voordelen

- Omdat elk product onafhankelijke volumeregelaars heeft, kunt u het geluid van uw Bose Smart Soundbar zachter zetten of uitschakelen en tegelijkertijd de hoofdtelefoon zo hard zetten als u wilt.
- U kunt vanuit een andere kamer naar uw muziek luisteren door de hoofdtelefoon te verbinden met uw Bose Smart Speaker.

OPMERKING: SimpleSync™-technologie heeft een *Bluetooth*-bereik van maximaal 9 meter. Muren en bouwmaterialen kunnen de ontvangst beïnvloeden.

Compatibele producten

U kunt de hoofdtelefoon verbinden met alle Bose Smart Speakers of Bose Smart Soundbars.

Populaire compatibele producten zijn onder meer:

- Bose Smart Soundbar 700/Bose Soundbar 700
- Bose Soundbar 500
- Bose Smart Speaker 500/Bose Home Speaker 500
- Bose Home Speaker 300
- Bose Portable Smart Speaker/Bose Portable Home Speaker

Er worden regelmatig nieuwe producten toegevoegd. Voor meer informatie en een volledige lijst gaat u naar: worldwide.Bose.com/Support/Groups

Verbinden via de Bose Music-app

1. Schuif de aan-uit-/*Bluetooth*-schakelaar op de hoofdtelefoon naar rechts ☒ en houd deze daar 3 seconden vast.

U hoort “Klaar om nog een apparaat te verbinden” en het statuslampje knippert blauw.

2. Gebruik de Bose Music-app om de hoofdtelefoon te verbinden met een compatibel Bose-product. Ga voor meer informatie naar: worldwide.Bose.com/Support/Groups

OPMERKINGEN:

- Zorg dat de hoofdtelefoon zich binnen 9 meter van uw soundbar of luidspreker bevindt.
- U kunt de hoofdtelefoon met slechts één product tegelijk verbinden.

OPNIEUW VERBINDEN MET EEN BOSE SMART SPEAKER OF SOUNDBAR

Schakel de hoofdtelefoon in (zie “Inschakelen” op pagina 16).

De hoofdtelefoon probeert verbinding te maken met het laatst verbonden *Bluetooth*-apparaat, bijvoorbeeld uw soundbar of luidspreker.

OPMERKINGEN:

- Uw soundbar of luidspreker moet zich binnen het bereik bevinden (9 m) en ingeschakeld zijn.
- Als de hoofdtelefoon niet opnieuw verbinding maakt, zie dan “De hoofdtelefoon wordt niet opnieuw verbonden met een eerder verbonden Bose Smart Soundbar of Speaker” op pagina 38.

DE HOOFDTELEFOON OPBERGEN

De oorschelpen kunnen worden gedraaid, zodat ze gemakkelijk kunnen worden opgeborgen. Plaats de hoofdtelefoon plat in het etui.

1. Draai beide oorschelpen naar binnen zodat ze plat liggen.



2. Vouw de linkeroorschelp omhoog in de richting van de hoofdband.

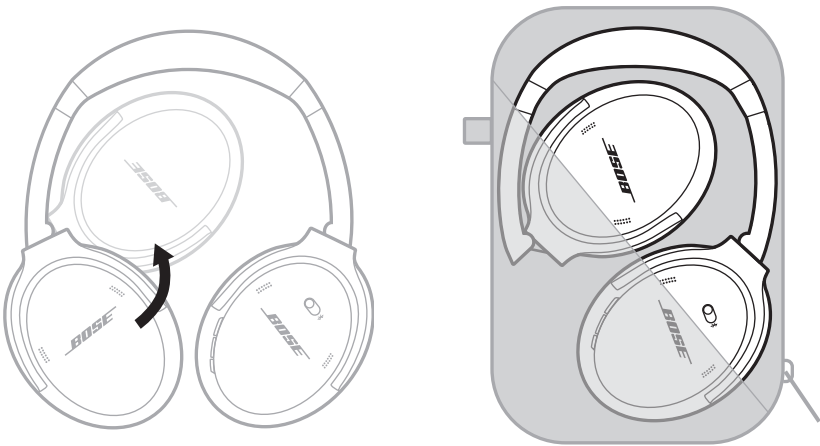

OPMERKINGEN:

- Zet de hoofdtelefoon uit wanneer deze niet in gebruik is.
- Zorg dat de accu volledig is opgeladen als u de hoofdtelefoon gedurende meer dan een paar maanden opbergt.

DE HOOFDTELEFOON SCHOONMAKEN

Neem de buitenkant af met een zachte, droge doek.

Voorkom dat er vocht in de oorschelpen komt.

RESERVEONDERDELEN EN ACCESSOIRES

Reserveonderdelen en accessoires kunt u bestellen via de Bose-klantenservice.

Ga naar: support.Bose.com/QCSE

BEPERKTE GARANTIE

De hoofdtelefoon wordt gedekt door een beperkte garantie. Ga naar onze website op worldwide.Bose.com/Warranty voor informatie over de beperkte garantie.

Om het product te registreren, gaat u naar worldwide.Bose.com/ProductRegistration voor instructies. Als u het product niet registreert, is dit niet van invloed op uw rechten onder de beperkte garantie.

PLAATS VAN HET SERIENUMMER

Het serienummer bevindt zich in de rechteroorschelp onder de afscherming. De afscherming is het doek dat de componenten in de oorschelp afdekt en beschermt.

Om het serienummer te zien, pakt u de afscherming aan de bovenrand vast en trekt u deze voorzichtig weg.

LET OP: Zorg dat u niet op andere componenten in de oorschelp duwt of deze verwijdert, aangezien dit kan leiden tot schade aan de hoofdtelefoon.

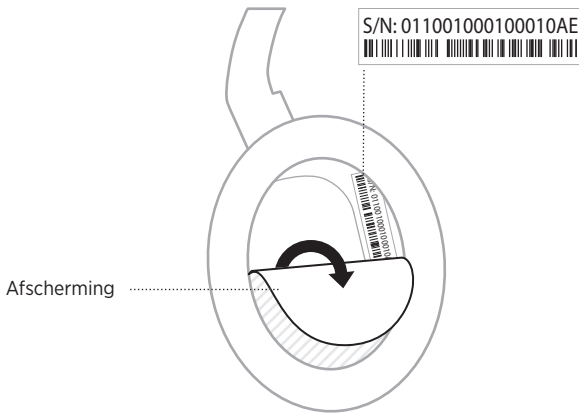

PROBEER DEZE OPLOSSINGEN EERST

Als u problemen hebt met de hoofdtelefoon:

- Controleer de status van het statuslampje (zie pagina 29).
- Laad de accu op (zie pagina 28).
- Zet het volume op uw hoofdtelefoon, mobiele apparaat en muziek-app hoger.
- Download de Bose Music-app en voer beschikbare software-updates uit (zie pagina 14).
- Probeer verbinding te maken met een ander mobiel apparaat (zie pagina 25).

Als het probleem nog niet is verholpen, zie dan de onderstaande tabel voor symptomen van en oplossingen voor veelvoorkomende problemen. Als u het probleem niet kunt oplossen, neem dan contact op met de Bose-klantenservice.

Ga naar: worldwide.Bose.com/contact

ANDERE OPLOSSINGEN

SYMPTOOM	OPLOSSING
De hoofdtelefoon kan niet worden ingeschakeld	Laad de accu op.
De hoofdtelefoon kan niet met uw mobiele apparaat worden verbonden	<p>Koppel de reserveaudiokabel los.</p> <p>Koppel de USB-oplaadkabel los.</p> <p>Op uw mobiele apparaat:</p> <p>Schakel de <i>Bluetooth</i>-functie uit en weer in.</p> <p>Verwijder uw Bose QuietComfort 45 headphones uit de <i>Bluetooth</i>-lijst op uw apparaat. Maak opnieuw verbinding.</p> <p>Plaats uw mobiele apparaat dichterbij de hoofdtelefoon en weg van mogelijke storingsbronnen of obstakels.</p> <p>Ga naar support.Bose.com/QCSE voor instructievideo's.</p> <p>Wis de lijst met verbonden apparaten (zie pagina 26) en maak opnieuw verbinding.</p>
De accu wordt niet opgeladen	<p>Sluit de uiteinden van de USB-oplaadkabel aan.</p> <p>Probeer een andere oplaadbron.</p> <p>Als de hoofdtelefoon blootgesteld is geweest aan hoge of lage temperaturen, laat de hoofdtelefoon dan op kamertemperatuur komen en probeer de accu opnieuw op te laden.</p>

SYMPTOOM	OPLOSSING
Geen geluid	<p>Zet de hoofdtelefoon aan en laad de accu op.</p> <p>Controleer de status van het statuslampje (zie pagina 29).</p> <p>Schuif de aan-uit-/Bluetooth-schakelaar naar rechts en laat deze los om het verbonden apparaat te horen. Zorg dat u het juiste apparaat gebruikt.</p> <p>Plaats uw mobiele apparaat dichterbij de hoofdtelefoon en weg van mogelijke storingsbronnen of obstakels.</p> <p>Gebruik een andere muziekbron.</p> <p>Als er twee mobiele apparaten verbonden zijn, pauzeer dan eerst het andere mobiele apparaat.</p> <p>Als er twee mobiele apparaten verbonden zijn, plaats de apparaten dan binnen het bereik van de hoofdtelefoon (9 m).</p> <p>Probeer een lokaal opgeslagen muziek- of videobestand op uw mobiele apparaat.</p>
Slechte geluidskwaliteit	<p>Gebruik een andere muziekbron.</p> <p>Maak verbinding met een ander mobiel apparaat (zie pagina 25).</p> <p>Verbreek de verbinding met het tweede apparaat.</p> <p>Plaats uw mobiele apparaat dichterbij de hoofdtelefoon en weg van mogelijke storingsbronnen of obstakels.</p> <p>Probeer een lokaal opgeslagen muziek- of videobestand op uw mobiele apparaat.</p>
Geen geluid uit een apparaat dat is aangesloten met de reserveaudiokabel	<p>Sluit de uiteinden van de reserveaudiokabel aan.</p> <p>Zet het volume op de hoofdtelefoon, uw mobiele apparaat en de muziekbron hoger.</p> <p>Maak verbinding met een ander apparaat (zie pagina 25).</p>
Slechte geluidskwaliteit uit een apparaat dat aangesloten is met een audiokabel	<p>Sluit de uiteinden van de reserveaudiokabel aan.</p> <p>Maak verbinding met een ander apparaat (zie pagina 25).</p>
De noise-cancelling-modus kan niet worden gewijzigd met de Actie-knop	<p>Controleer of de hoofdtelefoon aanstaat.</p> <p>Gebruik de Bose Music-app om de noise cancelling-modus te wijzigen.</p>

SYMPTOOM	OPLOSSING
<p>De hoofdtelefoon maakt geen verbinding met een Bose Smart Soundbar of Speaker</p>	<p>Verschuif de aan-uit-/<i>Bluetooth</i>-knop totdat u “Klaar om te verbinden met ander apparaat” hoort en het <i>Bluetooth</i>-lampje blauw knippert.</p> <p>Zorg dat de hoofdtelefoon zich binnen 9 meter van uw soundbar of luidspreker bevindt.</p>
<p>De hoofdtelefoon wordt niet opnieuw verbonden met een eerder verbonden Bose Smart Soundbar of Speaker</p>	<p>Maak opnieuw verbinding met een eerder verbonden apparaat (zie pagina 26).</p>
<p>Vertraagde audio bij verbinding met een Bose Smart Soundbar of Speaker</p>	<p>Download de Bose Music-app en voer beschikbare software-updates uit.</p>

Door de fabrieksinstellingen terug te zetten kunt u alle instellingen wissen en de hoofdtelefoon terugbrengen naar de oorspronkelijke staat. Daarna kunt u de hoofdtelefoon configureren alsof u deze voor de eerste keer instelt.

De fabrieksinstellingen terugzetten wordt alleen aangeraden als u problemen hebt met de hoofdtelefoon of als de Bose-klantenservice u heeft gevraagd dit te doen.

DE FABRIEKSINSTELLINGEN VAN DE HOOFDTELEFOON TERUGZETTEN

1. Verwijder de hoofdtelefoon uit de *Bluetooth*-lijst op uw apparaat.
2. Verwijder de hoofdtelefoon uit uw Bose-account via de Bose Music-app.

OPMERKING: Voor meer informatie over het verwijderen van de hoofdtelefoon uit uw Bose-account gaat u naar: support.bose.com/QCSE

3. Schuif de aan-uit-/*Bluetooth*-schakelaar naar rechts \times en houd deze daar vast. Houd tegelijkertijd de Actie-knop 30 seconden ingedrukt.

Het statuslampje knippert wit. Na 30 seconden gaat het statuslampje oranje knipperen om aan te geven dat de fabrieksinstellingen worden teruggezet (2 tot 3 seconden).

4. Wanneer de fabrieksinstellingen zijn teruggezet, knippert het statuslampje langzaam blauw. De hoofdtelefoon verkeert nu weer in de oorspronkelijke staat.

Lea y conserve todas las instrucciones de uso, protección y seguridad.

CE Por la presente, Bose Corporation declara que este producto cumple con los requisitos esenciales y con otras cláusulas relevantes de la Directiva 2014/53/EU y con todos los demás requisitos de directivas correspondientes de la UE. La declaración de conformidad completa se puede encontrar en: www.Bose.com/compliance

**UK
CA** Este producto cumple con todas las regulaciones aplicables de compatibilidad electromagnética de 2016 y todas las demás regulaciones aplicables del Reino Unido. La declaración de conformidad completa se puede encontrar en: www.Bose.com/compliance

Por la presente, Bose Corporation declara que este producto cumple con los requisitos esenciales de las Regulaciones de equipos de radio de 2017 y todas las demás regulaciones aplicables del Reino Unido. La declaración de conformidad completa se puede encontrar en: www.Bose.com/compliance

Instrucciones importantes de seguridad

No use este aparato cerca del agua.

Límpielo solamente con un paño seco.

Derive todas las tareas de servicio al personal calificado. Se requieren tareas de servicio si el aparato se daña de alguna manera, por ejemplo, si se dañó el enchufe o cable de alimentación, si se derramó líquido o cayeron objetos dentro del aparato, si el aparato estuvo expuesto a la lluvia o la humedad, si no funciona normalmente, o si se cayó.

ADVERTENCIAS/PRECAUCIONES

- NO use los auriculares a un volumen alto por un período prolongado.
 - Para evitar lesiones auditivas, use los auriculares en un nivel de volumen moderado y cómodo.
 - Baje el volumen del dispositivo antes de colocarse los auriculares, suba gradualmente el volumen hasta alcanzar un nivel de audición cómodo.
- NO use los auriculares para llamadas o cualquier otro fin mientras conduce.
- NO use los auriculares con el modo cancelación de ruido activado en ningún momento; la imposibilidad de escuchar ruidos puede presentar un peligro para usted y otros, por ejemplo, cuando anda en bicicleta o camina cerca o en medio del tráfico, una obra en construcción, las vías del ferrocarril, etc. y siga las leyes correspondientes referentes al uso de los auriculares.
 - Apague los auriculares o use los auriculares con el modo cancelación de ruido desactivado y ajuste el volumen para asegurarse de que puede oír los ruidos del entorno, incluyendo alarmas y señales de advertencia.
 - Tenga en cuenta que los sonidos que actúan como aviso o alerta pueden escucharse de forma diferente cuando se usan los auriculares, inclusive en el modo Atento.
- NO use los auriculares si emiten un ruido fuerte. Si esto sucede, apague los auriculares y comuníquese con el servicio al cliente de Bose.
- Quíteselos de inmediato si experimenta una sensación de calor o pérdida de audio.
- NO use adaptadores de teléfonos móviles para conectar los auriculares a enchufes de asientos de aviones, ya que podría producir lesiones o daños a la propiedad debido al sobrecalentamiento.
- NO use los auriculares como auriculares de comunicación en aeronaves.



Contiene piezas pequeñas que pueden representar un riesgo de asfixia. No recomendable para niños menores de 3 años.



Este producto contiene material magnético. Consulte con su médico si esto podría afectar a un dispositivo médico implantable.

- Para reducir el riesgo de incendio o descarga eléctrica, NO exponga este producto a la lluvia, goteo, salpicaduras o humedad y no coloque objetos llenos de líquido, como jarrones, sobre o cerca del producto.
- Mantenga el producto lejos del fuego y de fuentes de calor. NO coloque sobre el producto, o en su proximidad, fuentes de llamas al descubierto, como velas encendidas.
- Use este producto solamente con una fuente de alimentación LPS aprobada por una agencia que cumpla con los requisitos regulatorios locales (por ejemplo, UL, CSA, VDE, CCC).
- NO realice alteraciones no autorizadas a este producto.
- Si la batería pierde, evite que el líquido entre en contacto con la piel o los ojos. Si se produce el contacto, busque atención médica.
- No exponga productos con batería al calor excesivo, por ejemplo, almacenar a la luz directa del sol, cerca del fuego o similar.
- NO use los auriculares mientras se cargan.

NOTA: Este equipo ha sido sometido a prueba y se ha comprobado que cumple con los límites de un dispositivo digital Clase B, conforme a la Parte 15 de las reglas de la FCC. Estos límites están diseñados para ofrecer una protección razonable contra interferencias perjudiciales en una instalación domiciliaria. Este equipo genera, usa y puede irradiar energía de radiofrecuencia y, si no se instala y se usa conforme a las instrucciones, puede causar interferencia perjudicial a las comunicaciones de radio. Sin embargo, no se garantiza que la interferencia no se produzca en una instalación en particular. Si este equipo causa interferencias perjudiciales en la recepción de radio o televisión, que se puede determinar al apagar y encender el equipo, se aconseja al usuario intentar corregir la interferencia mediante una o más de las siguientes medidas:

- Reoriente o reubique el producto receptor o la antena.
- Aumente la separación entre el equipo y el receptor.
- Conecte el equipo a una salida eléctrica en un circuito diferente al que está conectado el receptor.
- Consulte con el distribuidor o con un técnico en radio o televisión experimentado para obtener ayuda.

Los cambios o las modificaciones no aprobadas expresamente por Bose Corporation podrían invalidar la autoridad del usuario para operar el equipo.

Este dispositivo cumple con la parte 15 de las reglas de la FCC y con las normas RSS sin licencia de ISED Canada. El funcionamiento está sujeto a las siguientes dos condiciones: (1) Este dispositivo no debe provocar interferencias dañinas y (2) Este dispositivo debe aceptar cualquier interferencia recibida, incluida la interferencia que puede causar un funcionamiento no deseado.

Este dispositivo cumple con los límites de exposición a la radiación de la FCC y de ISED Canada establecidos para la población en general. Este transmisor no se debe ubicar ni operar juntamente con otra antena o transmisor.

Cumple con los requisitos IMDA.

ID DE LA FCC: A94437310

IC: 3232A-437310

CAN ICES-3(B)/NMB-3(B)

Para Europa:

Banda de frecuencia de funcionamiento 2400 a 2483,5 MHz.

Potencia de transmisión máxima menor que 20 dBm EIRP.

Potencia de transmisión máxima está por debajo de los límites regulatorios y la prueba SAR no es necesaria y está exenta según las regulaciones aplicables.



Este símbolo significa que el producto no debe desecharse como residuo doméstico y que debe depositarse en un centro de recolección apropiado para reciclaje. La eliminación y el reciclado adecuados ayudan a proteger los recursos naturales, la salud de las personas y el medio ambiente. Para obtener más información sobre la eliminación y el reciclado de este producto, póngase en contacto con su municipio, el servicio de gestión de residuos o el comercio donde haya comprado este producto.

Regulaciones técnicas de dispositivos de radiofrecuencia de baja potencia

Sin el permiso concedido por la NCC, ninguna empresa, compañía o usuario puede cambiar la frecuencia, mejorar la potencia de transmisión ni alterar las características originales, así como el rendimiento a dispositivos de radiofrecuencia de baja potencia aprobados. Los dispositivos de radiofrecuencia de baja potencia no deberían afectar la seguridad del avión ni interferir con las comunicaciones legales; si se determinara una interferencia, el usuario deberá dejar de usar de inmediato hasta que no se perciba interferencia. Dichas comunicaciones legales implican que las comunicaciones de radio se operan conforme con la Ley de administración de telecomunicaciones. Los dispositivos de radiofrecuencia de bajo consumo deben ser susceptibles a la interferencia de las comunicaciones legales o de los dispositivos de ondas de radio ISM.

NO intente quitar la batería de ion-litio recargable de este producto. Contacte al distribuidor local de Bose u otro profesional calificado para quitar la batería.

La extracción de la batería de ion-litio recargable de este producto debe ser realizada por un profesional calificado. Póngase en contacto con el distribuidor Bose de su zona o vea products.bose.com/static/compliance/index.html para información adicional.



Desheche correctamente las baterías usadas, cumpliendo con las reglamentaciones locales. No incinere.



Nombres y contenidos de las sustancias o elementos tóxicos o peligrosos						
Nombre de parte	Sustancias y elementos tóxicos o peligrosos					
	Plomo (pb)	Mercurio (Hg)	Cadmio (Cd)	Hexavalente (CR(VI))	Bifenilo polibromado (PBB)	Difeniléter polibromado (PBDE)
PCB	X	0	0	0	0	0
Partes metálicas	X	0	0	0	0	0
Partes plásticas	0	0	0	0	0	0
Altavoz	X	0	0	0	0	0
Cables	X	0	0	0	0	0
Esta tabla se preparó conforme a las cláusulas de SJ/T 11364. O: Indica que esta sustancia tóxica o peligrosa contenida en todos los materiales homogéneos para esta parte es inferior al requisito de límite de GB/T 26572. X: Indica que esta sustancia tóxica o peligrosa que está presente en al menos uno de los materiales homogéneos utilizados para esta parte se encuentra por encima del requisito de límite de GB/T 26572.						

Fecha de fabricación: El octavo dígito del número de serie indica el año de fabricación; “2” es 2012 o 2022.

Importador en China: Bose Electronics (Shanghai) Company Limited, Level 6, Tower D, No. 2337 Gudai Rd. Minhang District, Shanghai 201100, China

Importador en UE: Bose Products B.V., Gorslaan 60, 1441 RG Purmerend, Países Bajos

Importador en México: Bose de México S. de R.L. de C.V., Avenida Prado Sur #150, Piso 2, Interior 222 y 223, Colonia Lomas de Chapultepec V Sección, Miguel Hidalgo, Ciudad de México, C.P. 11000 - Número de teléfono: +5255 (5202) 3545

Importador en Taiwán: Bose Limited Taiwan Branch (H.K.), 9F., No. 10, Sec. 3, Minsheng E. Road, Zhongshan Dist. Taipei City 10480, Taiwán - Número de teléfono: +886-2-2514 7676

Importador en el Reino Unido: Bose Limited, Bose House, Quayside Chatham Maritime, Chatham, Kent, ME4 4QZ, Reino Unido

Potencia de entrada: 5 V --- 0,5 A

Rango de temperaturas de carga: 0° C a 45° C

Rango de temperaturas de descarga: -20° C a 60° C

Modelo 437310. La ID de CMIIT se encuentra en el interior del audifono debajo del entelado.

Complete y conserve para referencia futura

Los números de serie y modelo se encuentran en el interior del audifono debajo del entelado.

Número de serie: _____

Número de modelo: _____

Guarde el recibo con la guía del usuario. Ahora es un buen momento para registrar su producto Bose.

Puede hacerlo fácilmente visitando worldwide.Bose.com/ProductRegistration

Información de seguridad

Este producto puede recibir actualizaciones de seguridad de Bose automáticamente cuando está conectado a la aplicación Bose Music. Para poder recibir actualizaciones de seguridad por la aplicación móvil, debe completar el proceso de configuración en la aplicación Bose Music. **Si no completa el proceso de configuración, será responsable de instalar las actualizaciones de seguridad disponibles de Bose a través de btu.Bose.com**

Apple, el logotipo de Apple, iPad, iPhone y iPod son marcas comerciales de Apple Inc., registradas en los Estados Unidos y en otros países. App Store es una marca de servicio de Apple Inc. La marca comercial "iPhone" se usa en Japón con una licencia de Aiphone K.K.

El uso del distintivo Fabricado para Apple significa que un accesorio se diseñó de forma específica para conectar a los productos Apple identificada en el distintivo y que cuenta con la certificación del desarrollador para cumplir con los estándares de rendimiento de Apple. Apple no es responsable del funcionamiento de este dispositivo o el cumplimiento con las normas de seguridad y disposiciones legales.

La marca y los logotipos de *Bluetooth*[®] son marcas comerciales registradas propiedad de Bluetooth SIG Inc. y cualquier uso de dichas marcas por parte de Bose Corporation se encuentra bajo licencia.

Google Play es una marca comercial de Google, LLC.

USB Type-C[®] y USB-C[®] son marcas comerciales registradas de USB Implementers Forum.

Bose, Bose Home Speaker, Bose Music, el logotipo Bose Music, Bose Smart Soundbar, Bose Smart Speaker, Bose Soundbar, QuietComfort y SimpleSync son marcas comerciales de Bose Corporation.

Sede central de Bose Corporation: 1-877-230-5639

©2022 Bose Corporation. No se puede reproducir, modificar, distribuir, o usar de otra manera ninguna parte de este trabajo sin previo consentimiento por escrito.

The following license disclosures apply to certain third-party software packages used as components in the product.

Package: FreeRTOS

Copyright © Amazon Web Services, Inc. or its affiliates. All rights reserved.

The FreeRTOS package is subject to the license terms reprinted below:

MIT License

Permission is hereby granted, free of charge, to any person obtaining a copy of this software and associated documentation files (the “Software”), to deal in the Software without restriction, including without limitation the rights to use, copy, modify, merge, publish, distribute, sublicense, and/or sell copies of the Software, and to permit persons to whom the Software is furnished to do so, subject to the following conditions:

The above copyright notice and this permission notice shall be included in all copies or substantial portions of the Software.

THE SOFTWARE IS PROVIDED “AS IS”, WITHOUT WARRANTY OF ANY KIND, EXPRESS OR IMPLIED, INCLUDING BUT NOT LIMITED TO THE WARRANTIES OF MERCHANTABILITY, FITNESS FOR A PARTICULAR PURPOSE AND NONINFRINGEMENT. IN NO EVENT SHALL THE AUTHORS OR COPYRIGHT HOLDERS BE LIABLE FOR ANY CLAIM, DAMAGES OR OTHER LIABILITY, WHETHER IN AN ACTION OF CONTRACT, TORT OR OTHERWISE, ARISING FROM, OUT OF OR IN CONNECTION WITH THE SOFTWARE OR THE USE OR OTHER DEALINGS IN THE SOFTWARE.

Package: Nanopb

Copyright © 2011 Petteri Aimonen <jpa at nanopb.mail.kapsi.fi>.

The Nanopb package is subject to the license terms reprinted below:

Zlib License

© 2011 Petteri Aimonen <jpa at nanopb.mail.kapsi.fi>

This software is provided ‘as-is’, without any express or implied warranty. In no event will the authors be held liable for any damages arising from the use of this software.

Permission is granted to anyone to use this software for any purpose, including commercial applications, and to alter it and redistribute it freely, subject to the following restrictions:

1. The origin of this software must not be misrepresented; you must not claim that you wrote the original software. If you use this software in a product, an acknowledgment in the product documentation would be appreciated but is not required.
2. Altered source versions must be plainly marked as such, and must not be misrepresented as being the original software.
3. This notice may not be removed or altered from any source distribution.

Package: Mbed TLS 2.16.1

© ARM Limited. All rights reserved.

The Mbed TLS package is subject to the license terms reprinted below:

Apache License

Version 2.0, January 2004

<http://www.apache.org/licenses/>

TERMS AND CONDITIONS FOR USE, REPRODUCTION, AND DISTRIBUTION

1. Definitions.
“License” shall mean the terms and conditions for use, reproduction, and distribution as defined by Sections 1 through 9 of this document.

“Licensor” shall mean the copyright owner or entity authorized by the copyright owner that is granting the License.

“Legal Entity” shall mean the union of the acting entity and all other entities that control, are controlled by, or are under common control with that entity. For the purposes of this definition, “control” means (i) the power, direct or indirect, to cause the direction or management of such entity, whether by contract or otherwise, or (ii) ownership of fifty percent (50%) or more of the outstanding shares, or (iii) beneficial ownership of such entity.

“You” (or “Your”) shall mean an individual or Legal Entity exercising permissions granted by this License.

“Source” form shall mean the preferred form for making modifications, including but not limited to software source code, documentation source, and configuration files.

“Object” form shall mean any form resulting from mechanical transformation or translation of a Source form, including but not limited to compiled object code, generated documentation, and conversions to other media types.

“Work” shall mean the work of authorship, whether in Source or Object form, made available under the License, as indicated by a copyright notice that is included in or attached to the work (an example is provided in the Appendix below).

“Derivative Works” shall mean any work, whether in Source or Object form, that is based on (or derived from) the Work and for which the editorial revisions, annotations, elaborations, or other modifications represent, as a whole, an original work of authorship. For the purposes of this License, Derivative Works shall not include works that remain separable from, or merely link (or bind by name) to the interfaces of, the Work and Derivative Works thereof.

“Contribution” shall mean any work of authorship, including the original version of the Work and any modifications or additions to that Work or Derivative Works thereof, that is intentionally submitted to Licensor for inclusion in the Work by the copyright owner or by an individual or Legal Entity authorized to submit on behalf of the copyright owner. For the purposes of this definition, “submitted” means any form of electronic, verbal, or written communication sent to the Licensor or its representatives, including but not limited to communication on electronic mailing lists, source code control systems, and issue tracking systems that are managed by, or on behalf of, the Licensor for the purpose of discussing and improving the Work, but excluding communication that is conspicuously marked or otherwise designated in writing by the copyright owner as “Not a Contribution.”

“Contributor” shall mean Licensor and any individual or Legal Entity on behalf of whom a Contribution has been received by Licensor and subsequently incorporated within the Work.

2. Grant of Copyright License. Subject to the terms and conditions of this License, each Contributor hereby grants to You a perpetual, worldwide, non-exclusive, no-charge, royalty-free, irrevocable copyright license to reproduce, prepare Derivative Works of, publicly display, publicly perform, sublicense, and distribute the Work and such Derivative Works in Source or Object form.
3. Grant of Patent License. Subject to the terms and conditions of this License, each Contributor hereby grants to You a perpetual, worldwide, non-exclusive, no-charge, royalty-free, irrevocable (except as stated in this section) patent license to make, have made, use, offer to sell, sell, import, and otherwise transfer the Work, where such license applies only to those patent claims licensable by such Contributor that are necessarily infringed by their Contribution(s) alone or by combination of their Contribution(s) with the Work to which such Contribution(s) was submitted. If You institute patent litigation against any entity (including a cross-claim or counterclaim in a lawsuit) alleging that the Work or a Contribution incorporated within the Work constitutes direct or contributory patent infringement, then any patent licenses granted to You under this License for that Work shall terminate as of the date such litigation is filed.
4. Redistribution. You may reproduce and distribute copies of the Work or Derivative Works thereof in any medium, with or without modifications, and in Source or Object form, provided that You meet the following conditions:
 - a. You must give any other recipients of the Work or Derivative Works a copy of this License; and
 - b. You must cause any modified files to carry prominent notices stating that You changed the files; and
 - c. You must retain, in the Source form of any Derivative Works that You distribute, all copyright, patent, trademark, and attribution notices from the Source form of the Work, excluding those notices that do not pertain to any part of the Derivative Works; and

d. If the Work includes a “NOTICE” text file as part of its distribution, then any Derivative Works that You distribute must include a readable copy of the attribution notices contained within such NOTICE file, excluding those notices that do not pertain to any part of the Derivative Works, in at least one of the following places: within a NOTICE text file distributed as part of the Derivative Works; within the Source form or documentation, if provided along with the Derivative Works; or, within a display generated by the Derivative Works, if and wherever such third-party notices normally appear. The contents of the NOTICE file are for informational purposes only and do not modify the License. You may add Your own attribution notices within Derivative Works that You distribute, alongside or as an addendum to the NOTICE text from the Work, provided that such additional attribution notices cannot be construed as modifying the License.

You may add Your own copyright statement to Your modifications and may provide additional or different license terms and conditions for use, reproduction, or distribution of Your modifications, or for any such Derivative Works as a whole, provided Your use, reproduction, and distribution of the Work otherwise complies with the conditions stated in this License.

5. Submission of Contributions. Unless You explicitly state otherwise, any Contribution intentionally submitted for inclusion in the Work by You to the Licensor shall be under the terms and conditions of this License, without any additional terms or conditions. Notwithstanding the above, nothing herein shall supersede or modify the terms of any separate license agreement you may have executed with Licensor regarding such Contributions.
6. Trademarks. This License does not grant permission to use the trade names, trademarks, service marks, or product names of the Licensor, except as required for reasonable and customary use in describing the origin of the Work and reproducing the content of the NOTICE file.
7. Disclaimer of Warranty. Unless required by applicable law or agreed to in writing, Licensor provides the Work (and each Contributor provides its Contributions) on an “AS IS” BASIS, WITHOUT WARRANTIES OR CONDITIONS OF ANY KIND, either express or implied, including, without limitation, any warranties or conditions of TITLE, NON-INFRINGEMENT, MERCHANTABILITY, or FITNESS FOR A PARTICULAR PURPOSE. You are solely responsible for determining the appropriateness of using or redistributing the Work and assume any risks associated with Your exercise of permissions under this License.
8. Limitation of Liability. In no event and under no legal theory, whether in tort (including negligence), contract, or otherwise, unless required by applicable law (such as deliberate and grossly negligent acts) or agreed to in writing, shall any Contributor be liable to You for damages, including any direct, indirect, special, incidental, or consequential damages of any character arising as a result of this License or out of the use or inability to use the Work (including but not limited to damages for loss of goodwill, work stoppage, computer failure or malfunction, or any and all other commercial damages or losses), even if such Contributor has been advised of the possibility of such damages.
9. Accepting Warranty or Additional Liability. While redistributing the Work or Derivative Works thereof, You may choose to offer, and charge a fee for, acceptance of support, warranty, indemnity, or other liability obligations and/or rights consistent with this License. However, in accepting such obligations, You may act only on Your own behalf and on Your sole responsibility, not on behalf of any other Contributor, and only if You agree to indemnify, defend, and hold each Contributor harmless for any liability incurred by, or claims asserted against, such Contributor by reason of your accepting any such warranty or additional liability.

END OF TERMS AND CONDITIONS

©2022 Bose Corporation

Licensed under the Apache License, Version 2.0 (the “License”); you may not use this file except in compliance with the License.

You may obtain a copy of the License at: <http://www.apache.org/licenses/LICENSE-2.0>

Unless required by applicable law or agreed to in writing, software distributed under the License is distributed on an “AS IS” BASIS, WITHOUT WARRANTIES OR CONDITIONS OF ANY KIND, either express or implied.

See the License for the specific language governing permissions and limitations under the License.

CONTENIDO DE LA CAJA

Contenido 13

APLICACIÓN BOSE MUSIC

Descargar la aplicación Bose Music 14
 Agregar los auriculares a una cuenta existente..... 14

CONTROLES DE LOS AURICULARES

Encender 16
 Temporizador en espera 16
 Apagar 17
 Funciones de los auriculares 18
 Reproducción multimedia y volumen..... 18
 Llamadas telefónicas..... 19
 Botón Acción..... 20

CANCELACIÓN DE RUIDO

Modos de cancelación de ruido 21
 Cambiar el modo de cancelación de ruido..... 21

CONTROL DE VOZ

Acceder al control de voz..... 22

CONEXIONES BLUETOOTH®

Conectar usando la función *Bluetooth* en el dispositivo móvil 23
 Desconectar un dispositivo móvil 25
 Volver a conectar un dispositivo móvil 25
 Conectar otro dispositivo móvil..... 25
 Identificar dispositivos móviles conectados 25
 Cambiar entre dos dispositivos móviles conectados 25
 Volver a conectar un dispositivo previamente conectado 26
 Borrar la lista de dispositivos de los auriculares 26

CONEXIONES CON CABLE

Conectar el cable de audio 27

BATERÍA

Cargar los auriculares..... 28
 Tiempo de carga 28
 Escuchar el nivel de carga de la batería 28

ESTADO DE LOS AURICULARES

Estado de *Bluetooth* 29
 Estado de la batería 29
 Estado de la carga 30
 Estado de actualización y errores 30

CONECTAR PRODUCTOS BOSE

Conectar una barra de sonido Bose Smart Soundbar o un altavoz
 Bose Smart Speaker 31
 Ventajas 31
 Productos compatibles 31
 Conectar usando la aplicación Bose Music 31
 Reconectar a un altavoz Bose Smart Speaker o a una barra de
 sonido Bose Smart Soundbar 32

CUIDADO Y MANTENIMIENTO

Guardar los auriculares..... 33
 Limpiar los auriculares..... 34
 Repuestos y accesorios..... 34
 Garantía limitada..... 34
 Ubicación del número de serie..... 35

SOLUCIÓN DE PROBLEMAS

Intente primero con estas soluciones 36

Otras soluciones 36

Restablecer los auriculares a la configuración de fábrica 39

CONTENIDO

Confirme que estén incluidas las siguientes partes:



Bose QuietComfort 45 headphones

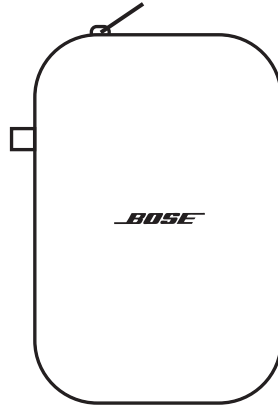

Estuche blando de transporte

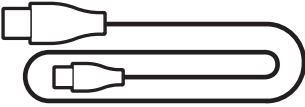

Cable USB Type-C®

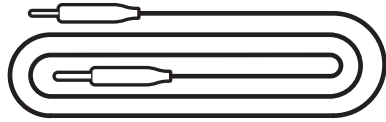

Cable de audio de 3,5 a 2,5 mm

NOTA: Si cualquier parte del producto está dañada, no lo use. Comuníquese con un representante autorizado de Bose o al Servicio al cliente de Bose.

Visite: support.Bose.com/QCSE

La aplicación Bose Music permite configurar y controlar los auriculares desde cualquier dispositivo móvil, como un teléfono inteligente o tableta.

Con la aplicación, puede controlar las conexiones *Bluetooth*, la configuración de los auriculares, elegir el idioma de las indicaciones de voz y acceder a nuevas funciones mediante las actualizaciones.

NOTA: Si ya creó una cuenta Bose Music para otro producto Bose, agregue los auriculares a su cuenta existente (vea la parte inferior de la página 14).

DESCARGAR LA APLICACIÓN BOSE MUSIC

1. En el dispositivo móvil, descargue la aplicación Bose Music.

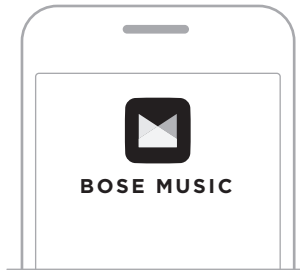

2. Siga las instrucciones de la aplicación.

AGREGAR LOS AURICULARES A UNA CUENTA EXISTENTE

Para agregar los auriculares Bose QuietComfort 45, abra la aplicación Bose Music y agregue los auriculares.

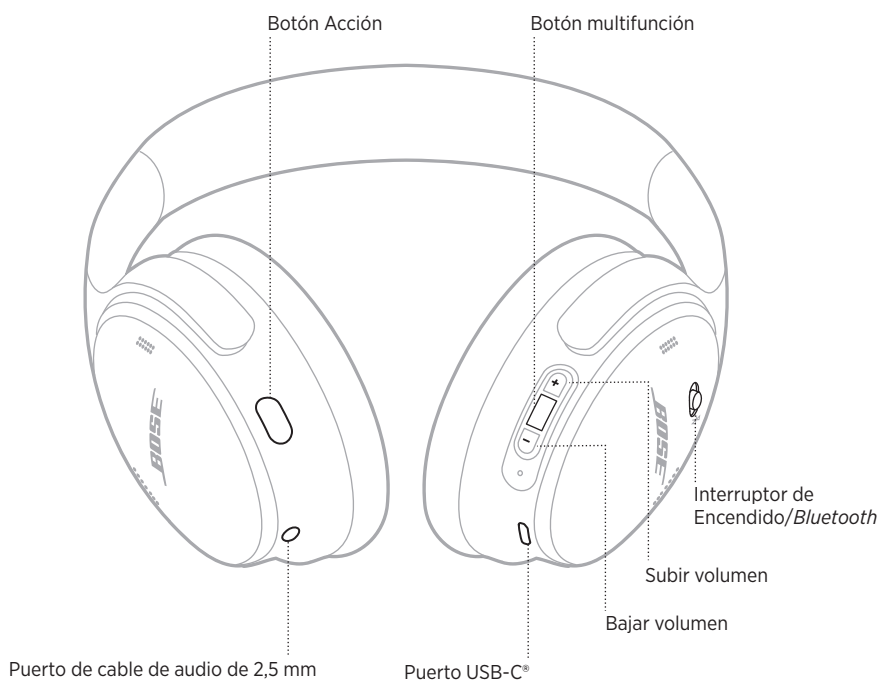

ENCENDER

En el audífono derecho, deslice el interruptor de encendido/*Bluetooth* hacia la derecha.

Una indicación de voz informa sobre el nivel de la batería y la luz de estado se ilumina según el nivel de carga actual (vea la página 29).



Temporizador en espera

El temporizador en espera ahorra la batería cuando no se están usando los auriculares.

Para configurar y personalizar el temporizador en espera, use la aplicación Bose Music.

APAGAR

Deslice el interruptor de encendido/*Bluetooth* hacia la izquierda.



NOTA: Cuando los auriculares se apagan, se desactiva la función de cancelación de ruido.

FUNCIONES DE LOS AURICULARES

Los controles de los auriculares se encuentran en la parte posterior del audífono derecho.

Reproducción multimedia y volumen

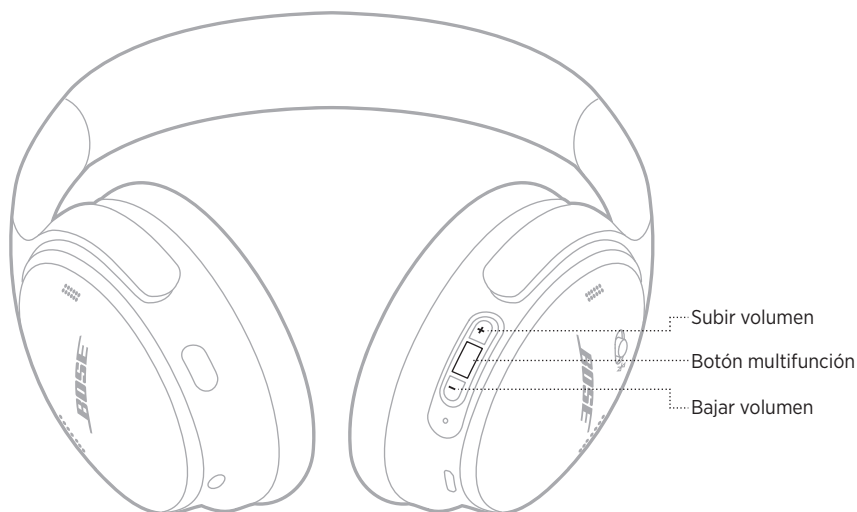

FUNCIÓN	QUÉ HACER
Reproducir/Pausa	Presione el botón multifunción.
Saltar a la pista siguiente	Presione dos veces el botón multifunción.
Salto atrás	Presione el botón multifunción tres veces.
Subir volumen	Presione +.
Bajar volumen	Presione —.

NOTAS:

- Para subir el volumen rápidamente, mantenga presionado +.
- Para bajar el volumen rápidamente, mantenga presionado —.

Llamadas telefónicas

El botón multifunción se encuentra en la parte posterior del audífono derecho.
El micrófono se encuentra cerca de la parte delantera del audífono derecho.

El botón Acción se encuentra en la parte posterior del Audífono izquierdo.

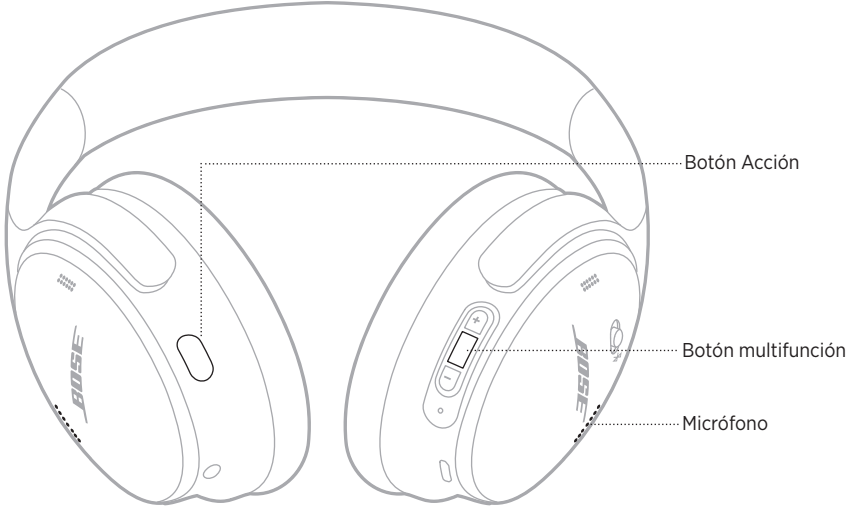

FUNCIÓN	QUÉ HACER
Contestar/terminar una llamada	Presione el botón multifunción.
Rechazar una llamada entrante	Mantenga presionado el botón multifunción por 1 segundo.
Contestar una segunda llamada entrante y poner la llamada en curso en espera	Mientras está en una llamada y hay una segunda llamada entrante, presione el botón multifunción.
Rechazar la segunda llamada entrante y continuar con la llamada en curso	Mientras está en una llamada y hay una segunda llamada entrante, presione el botón multifunción por 1 segundo.
Cambiar entre dos llamadas	Cuando hay dos llamadas activas, presione dos veces el botón multifunción.
Crear una llamada conferencia	Cuando hay dos llamadas activas, mantenga presionado el botón multifunción por 3 segundos.
Silenciar/restaurar el audio de una llamada	Durante una llamada, presione dos veces el botón Acción.

Botón Acción

El botón Acción permite de forma rápida y fácil cambiar de modo de cancelación de ruido.

El botón Acción se encuentra en la parte posterior del Audífono izquierdo.

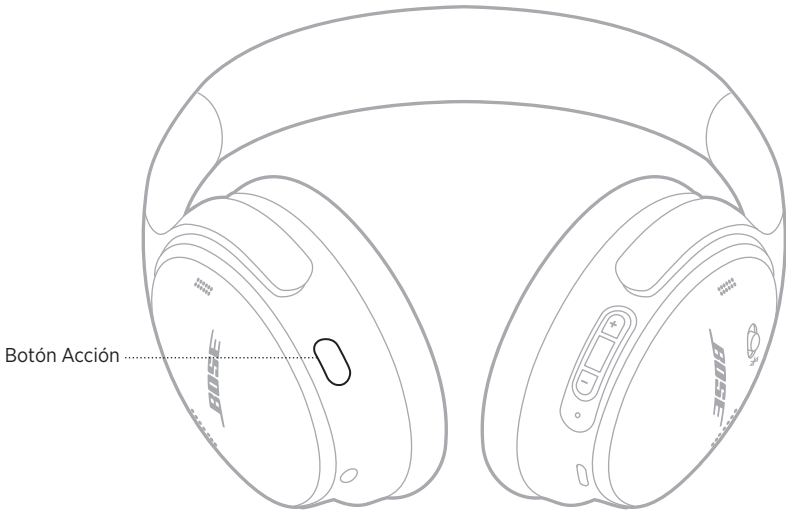

Para cambiar entre el modo Silencioso y el modo Atento, presione el botón Acción.

Para más información sobre los modos de cancelación de ruido, vea la página 21.

La cancelación de ruido reduce los ruidos no deseados, brindando un desempeño de audio más nítido y real. Puede elegir entre dos modos de cancelación de ruido: Silencioso y Atento.

El modo Silencioso permite bloquear las distracciones usando el nivel más alto de cancelación de ruido.

El modo Atento brinda una transparencia total y permite oír el entorno mientras disfruta del audio.

Elija el modo de cancelación de ruido según sus preferencias de audio y del entorno.

MODOS DE CANCELACIÓN DE RUIDO

MODO	DESCRIPCIÓN
Silencioso	Cancelación de ruido de primera clase con el audio optimizado de Bose.
Atento	Esté atento al entorno mientras disfruta del audio.

NOTA: Cuando se encienden, los auriculares usan como valor predeterminado el último modo que usó.

CAMBIAR EL MODO DE CANCELACIÓN DE RUIDO

Para cambiar el modo de cancelación de ruido, presione el botón Acción.

Una indicación de voz anuncia el modo de cancelación de ruido seleccionado.

SUGERENCIA: También puede cambiar el modo de cancelación de ruido usando la aplicación Bose Music.

ACCEDER AL CONTROL DE VOZ

Puede usar los auriculares para acceder al control de voz en el dispositivo móvil. Para acceder al control de voz, mantenga presionado el botón multifunción por 1 segundo.

El botón multifunción se encuentra en la parte posterior del audífono derecho.

NOTA: No puede acceder al control de voz mientras esté en una llamada.

CONECTAR USANDO LA FUNCIÓN *BLUETOOTH* EN EL DISPOSITIVO MÓVIL

Se pueden almacenar hasta ocho dispositivos en la lista de dispositivos de los auriculares y los auriculares pueden estar conectados a dos dispositivos al mismo tiempo. Puede reproducir audio solo de un dispositivo a la vez.

NOTA: Para una mejor funcionalidad, use la aplicación Bose Music para configurar y conectar el dispositivo móvil (vea la página 14).

1. Deslice el interruptor de encendido/*Bluetooth* ➔ hacia la derecha y mantenga presionado por 3 segundos.

Se oye “Listo para conectar” y la luz de estado parpadea de color azul.



2. En su dispositivo, active la función *Bluetooth*.

NOTA: Generalmente, la función *Bluetooth* se encuentra en el menú de configuración.

3. Seleccione sus auriculares de la lista de dispositivos.

SUGERENCIA: Busque el nombre que le asignó a los auriculares en la aplicación Bose Music. Si no les asignó un nombre, aparece el nombre predefinido.



Una vez conectado, se oye "Conectado a <nombre del dispositivo>" y la luz de estado se ilumina de color azul por 10 segundos.

DESCONECTAR UN DISPOSITIVO MÓVIL

Use la aplicación Bose Music para desconectar el dispositivo móvil.

SUGERENCIA: También puede usar la configuración de *Bluetooth* para desconectar su dispositivo. Al desactivar la función *Bluetooth* se desconectan todos los demás dispositivos.

VOLVER A CONECTAR UN DISPOSITIVO MÓVIL

Cuando se encienden, los auriculares intentan reconectarse a los dos dispositivos conectados más recientemente.

NOTAS:

- El dispositivo debe estar dentro del rango de alcance (9 m) y encendido.
- Asegúrese de que la función *Bluetooth* esté activada en el dispositivo móvil.

CONECTAR OTRO DISPOSITIVO MÓVIL

Para conectar otro dispositivo, descargue la aplicación Bose Music (vea la página 14) o use el menú *Bluetooth* del dispositivo móvil (vea la página 23).

NOTA: Solo puede reproducir audio desde un dispositivo a la vez.

IDENTIFICAR DISPOSITIVOS MÓVILES CONECTADOS

Deslice el interruptor de encendido/*Bluetooth*  hacia la derecha y suéltelo para oír qué dispositivo está actualmente conectado.

CAMBIAR ENTRE DOS DISPOSITIVOS MÓVILES CONECTADOS

1. Ponga el audio en pausa en el primer dispositivo móvil.
2. Reproduzca el audio en el segundo dispositivo móvil.

NOTA: Los auriculares reciben llamadas de ambos dispositivos, independientemente del dispositivo que esté reproduciendo audio.

VOLVER A CONECTAR UN DISPOSITIVO PREVIAMENTE CONECTADO

1. Deslice el interruptor de encendido/*Bluetooth* ☒ hacia la derecha y suéltelo para oír qué dispositivo está conectado.
2. En los siguientes 2 segundos, deslice el interruptor de encendido/*Bluetooth* ☒ hacia la derecha y vuelva a soltarlo para conectar el próximo dispositivo en la lista de dispositivos de los auriculares.
3. Repita hasta que oiga el nombre del dispositivo correcto.
Se oye un tono que indica cuándo el dispositivo está conectado.
4. Reproduzca audio en el dispositivo móvil conectado.

NOTA: Si ya hay dos dispositivos conectados a los auriculares, el dispositivo conectado más recientemente reemplaza al segundo dispositivo que estaba conectado anteriormente.

BORRAR LA LISTA DE DISPOSITIVOS DE LOS AURICULARES

1. Deslice el interruptor de encendido/*Bluetooth* ☒ hacia la derecha y mantenga presionado por 15 segundos, hasta que oiga "Se eliminó dispositivo *Bluetooth*. Listo para conectar."
2. Elimine los auriculares de la lista *Bluetooth* en su dispositivo móvil.
Se borran todos los dispositivos y los auriculares están listos para conectar.

CONECTAR EL CABLE DE AUDIO

Use el cable de 2,5 mm a 3,5 mm para conectar un dispositivo con cable o para continuar usando los auriculares si la batería está descargada.

1. Conecte el cable al puerto de 2,5 mm en el audífono izquierdo.



2. Conecte otro extremo del cable al puerto de 3,5 mm en el dispositivo.

NOTA: Puede usar los auriculares encendidos o apagados cuando el cable de audio está conectado.

CARGAR LOS AURICULARES

1. Conecte el extremo pequeño del cable USB al puerto USB-C del audífono derecho.
2. Conecte el otro extremo a un cargador de pared tipo USB.



NOTAS:

- Cuando los auriculares se están cargando, la luz de estado parpadea de color blanco por 10 segundos. Cuando están totalmente cargados, la luz de estado se ilumina de color blanco.
- Los auriculares no reproducen sonido mientras se están cargando.

Tiempo de carga

Espere hasta 2,5 horas para cargar completamente los auriculares.

Escuchar el nivel de carga de la batería

Cada vez que enciende los auriculares, las indicaciones de voz anuncian el nivel de carga de la batería. Cuando la batería de los auriculares está baja, se oye "Batería baja, cargar ahora".

NOTA: Para comprobar visualmente la batería, vea la luz de estado que se encuentra en el audífono derecho. Para obtener más información, vea "Estado de la batería" en la página 29.

La luz de estado se encuentra en el audífono derecho.



ESTADO DE *BLUETOOTH*

Muestra el estado de la conexión *Bluetooth*.

ACTIVIDAD DE LAS LUCES	ESTADO DEL SISTEMA
Azul intermitente	Listo para conectar
Color azul (10 segundos)	Conectado

ESTADO DE LA BATERÍA

Muestra el nivel de carga de la batería.

ACTIVIDAD DE LAS LUCES	ESTADO DEL SISTEMA
Color blanco	Carga media a completa
Color ámbar	Carga baja

SUGERENCIA: También puede verificar el nivel de la batería usando la aplicación Bose Music.

ESTADO DE LA CARGA

Muestra el estado de la carga.

ACTIVIDAD DE LAS LUCES	ESTADO DEL SISTEMA
Parpadea 2 veces de color blanco	Comienza la carga
Color ámbar	Cargando
Color blanco	Carga completa

ESTADO DE ACTUALIZACIÓN Y ERRORES

Muestra el estado de actualización o de error.

ACTIVIDAD DE LAS LUCES	ESTADO DEL SISTEMA
Blanco intermitente rápido (10 segundos)	Actualizando el software (por USB)
Blanco intermitente lento (30 a 60 segundos)	Actualizando el software (de forma inalámbrica)
Parpadea de color ámbar y blanco	Error - contactar al servicio técnico de Bose

CONECTAR UNA BARRA DE SONIDO BOSE SMART SOUNDBAR O UN ALTAVOZ BOSE SMART SPEAKER

Con la tecnología SimpleSync™, puede conectar los auriculares a una barra de sonido Bose Smart Soundbar o altavoz Bose Smart Speaker para disfrutar de una experiencia personal de audio.

Ventajas

- Use los controles de volumen independientes en cada producto para bajar el volumen o silenciar la barra de sonido Bose Smart Soundbar mientras mantiene el volumen de los auriculares tan alto como desee.
- Escuche la música desde la habitación de al lado conectando los auriculares al altavoz Smart Speaker.

NOTA: La tecnología SimpleSync™ tiene un alcance *Bluetooth* de hasta 9 metros. Las paredes y los materiales de construcción pueden afectar la recepción.

Productos compatibles

Puede conectar los auriculares a cualquier altavoz Bose Smart Speaker o barra de sonido Bose Smart Soundbar.

Los productos populares compatibles incluyen:

- Barra de sonido Bose Smart Soundbar 700/Bose Soundbar 700
- Bose Soundbar 500
- Altavoz Bose Smart Speaker 500/Bose Home Speaker 500
- Altavoz Bose Home Speaker 300
- Altavoz Bose Portable Smart Speaker/Bose Portable Home Speaker

Se agregan nuevos productos periódicamente. Para obtener una lista completa y más información, visite: worldwide.Bose.com/Support/Groups

Conectar usando la aplicación Bose Music

1. En los auriculares, deslice el interruptor de encendido/*Bluetooth* ⌘ hacia la derecha y mantenga presionado por 3 segundos.

Se oye “Listo para conectar otro dispositivo” y la luz de estado parpadea en color azul.

2. Use la aplicación Bose Music para conectar los auriculares a un producto Bose compatible. Para obtener más información, visite: worldwide.Bose.com/Support/Groups

NOTAS:

- Asegúrese de que los auriculares están a menos de 9 m de la barra de sonido o del altavoz.
- Puede conectar los auriculares solo a un producto a la vez.

RECONECTAR A UN ALTAVOZ BOSE SMART SPEAKER O A UNA BARRA DE SONIDO BOSE SMART SOUNDBAR

Encienda los auriculares (vea la “Encender” en la página 16).

Los auriculares intentan conectarse con los dos dispositivos *Bluetooth* más recientemente conectados, incluyendo la barra de sonido o el altavoz.

NOTAS:

- La barra de sonido o el altavoz debe estar dentro del rango de alcance (9 m) y encendido.
- Si los auriculares no se vuelven a conectar, vea “Los auriculares no se reconectan a una barra de sonido Bose Smart Soundbar o altavoz Bose Smart Speaker anteriormente conectado” en la página 38.

GUARDAR LOS AURICULARES

Los audífonos se pueden girar para guardarlos fácilmente. Coloque los auriculares planos en el estuche.

1. Gire ambos audífonos hacia adentro para que queden planos.



2. Pliegue el aurifono izquierdo hacia la banda de ajuste.

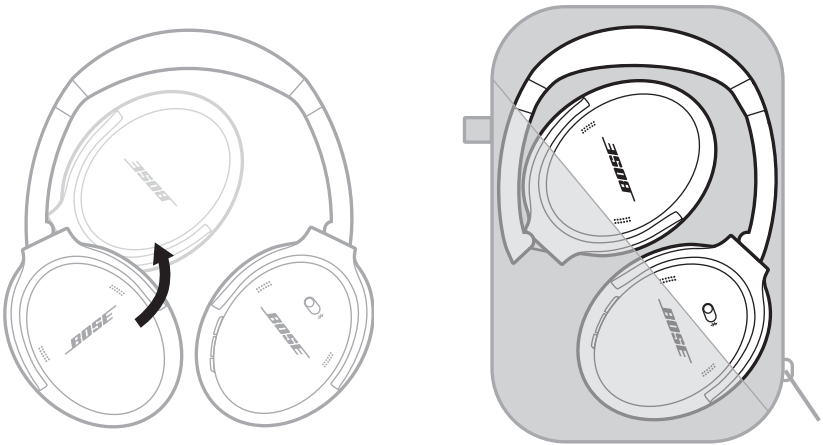

NOTAS:

- Asegúrese de apagar los auriculares cuando no se estén usando.
- Antes de guardar los auriculares por más de unos meses, verifique que la batería esté completamente cargada.

LIMPIAR LOS AURICULARES

Limpie la superficie externa con un paño suave y seco.

Evite que penetre humedad en los audífonos.

REPUESTOS Y ACCESORIOS

Los repuestos y accesorios se pueden pedir al Servicio de atención al cliente de Bose. Visite: support.Bose.com/QCSE

GARANTÍA LIMITADA

Los auriculares están cubiertos por una garantía limitada. Visite nuestro sitio Web en worldwide.Bose.com/Warranty para obtener más detalles sobre la garantía limitada.

Para registrar el producto, visite worldwide.Bose.com/ProductRegistration para obtener instrucciones. Si no lo registra, no afectará sus derechos de garantía limitada.

UBICACIÓN DEL NÚMERO DE SERIE

El número de serie se encuentra en el interior del audífono derecho debajo del entelado. El entelado es el protector interior que cubre y protege los componentes dentro del audífono.

Para ver el número de serie, sujete el entelado por el borde superior y despéguelo suavemente.

PRECAUCIÓN: Tenga cuidado de no ejercer presión ni quitar ningún otro componente del interior del Audífono ya que esto podría dañar los auriculares.

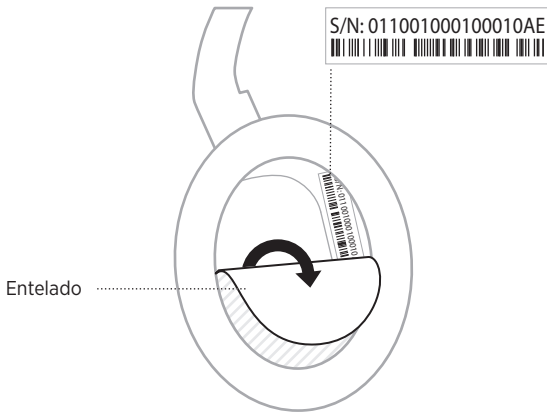

INTENTE PRIMERO CON ESTAS SOLUCIONES

Si tiene problemas con los auriculares:

- Compruebe el estado de la luz de estado (vea la página 29).
- Cargue la batería (vea la página 28).
- Suba el volumen de los auriculares, dispositivo móvil y de la aplicación de música.
- Descargue la aplicación Bose Music y ejecute las actualizaciones de software disponibles (vea la página 14).
- Pruebe conectar otro dispositivo móvil (vea la página 25).

Si no pudo resolver el problema, consulte la siguiente tabla para identificar síntomas y soluciones a problemas frecuentes. Si no puede resolver el problema, póngase en contacto con el servicio de atención al cliente de Bose.

Visite: worldwide.Bose.com/contact

OTRAS SOLUCIONES

SÍNTOMA	SOLUCIÓN
Los auriculares no se encienden	Cargue la batería.
Los auriculares no se conectan al dispositivo móvil	<p>Desconecte el cable de audio de reserva.</p> <p>Desconecte el cable de carga USB.</p> <p>En su dispositivo móvil:</p> <p>Desactive la función de <i>Bluetooth</i> y vuelva a activarla.</p> <p>Elimine los auriculares Bose QuietComfort 45 de la lista <i>Bluetooth</i> en el dispositivo, incluyendo los listados duplicados marcados como LE (Low Energy). Vuelva a conectarlos.</p> <p>Acerque el dispositivo móvil a los auriculares, y aléjelo de interferencias u obstrucciones.</p> <p>Visite: worldwide.Bose.com/Support/QCSE para ver videos instructivos.</p> <p>Borre la lista de dispositivos conectados (vea la página 26) y vuelva a conectarlos.</p>
La batería no se carga	<p>Asegure los extremos del cable de carga USB.</p> <p>Pruebe otra fuente de carga.</p> <p>Si los auriculares han estado expuestos a altas o bajas temperaturas, espere a que los auriculares regresen a la temperatura ambiente y vuelva a intentar cargarlos.</p>

SÍNTOMA	SOLUCIÓN
No hay sonido	<p>Encienda los auriculares y cargue la batería.</p> <p>Compruebe el estado de la luz de estado (vea la página 29).</p> <p>Deslice el interruptor de encendido/<i>Bluetooth</i> hacia la derecha y suelte para oír el dispositivo conectado. Verifique que esté usando el dispositivo correcto.</p> <p>Acerque el dispositivo móvil a los auriculares, y aléjelo de interferencias u obstrucciones.</p> <p>Use una fuente de música diferente.</p> <p>Si hay dos dispositivos móviles conectados, ponga en pausa primero el otro dispositivo.</p> <p>Si hay dos dispositivos móviles conectados, mueva los dispositivos dentro del rango de alcance de los auriculares (9 m).</p> <p>Pruebe con un archivo de video o música almacenado en el dispositivo móvil.</p>
Calidad de sonido deficiente	<p>Use una fuente de música diferente.</p> <p>Conecte otro dispositivo móvil (vea la página 25).</p> <p>Desconecte el segundo dispositivo.</p> <p>Acerque el dispositivo móvil a los auriculares, y aléjelo de interferencias u obstrucciones.</p> <p>Pruebe con un archivo de video o música almacenado en el dispositivo móvil.</p>
No hay sonido desde un dispositivo conectado por el cable de audio de reserva	<p>Asegure los extremos del cable de audio de reserva.</p> <p>Suba el volumen de los auriculares, del dispositivo móvil y de la fuente de música.</p> <p>Conecte otro dispositivo (vea la página 25).</p>
Calidad de audio deficiente de un dispositivo conectado por cable de audio	<p>Asegure los extremos del cable de audio de reserva.</p> <p>Conecte otro dispositivo (vea la página 25).</p>
El botón Acción no cambia el modo de cancelación de ruido	<p>Asegúrese de que los auriculares están encendidos.</p> <p>Use la aplicación Bose Music para cambiar el modo de la cancelación de ruido.</p>

SÍNTOMA	SOLUCIÓN
Los auriculares no se conectan a una barra de sonido Bose Smart Soundbar o altavoz Bose Smart Speaker	<p>Deslice y mantenga presionado el botón de encendido/<i>Bluetooth</i> hasta que oiga “Listo para conectar a otro dispositivo” y la luz de <i>Bluetooth</i> parpadea de color azul.</p> <p>Asegúrese de que los auriculares están a menos de 9 m de la barra de sonido o del altavoz.</p>
Los auriculares no se reconectan a una barra de sonido Bose Smart Soundbar o altavoz Bose Smart Speaker anteriormente conectado	<p>Vuelva a conectar un dispositivo móvil anteriormente conectado (vea la página 26).</p>
Audio retrasado cuando están conectados a una barra de sonido Bose Smart Soundbar o altavoz Bose Smart Speaker	<p>Descargue la aplicación Bose Music y ejecute las actualizaciones de software disponibles.</p>

Si se restablece a la configuración de fábrica puede borrar toda la configuración y volver los auriculares a su estado original de fábrica. Después, los auriculares se pueden configurar como si se estuvieran configurando por primera vez.

Solo se recomienda restablecer a la configuración de fábrica si tiene problemas con los auriculares o el servicio de atención al cliente de Bose le indicó que lo haga.

RESTABLECER LOS AURICULARES A LA CONFIGURACIÓN DE FÁBRICA

1. Elimine los auriculares de la lista *Bluetooth* del dispositivo.
2. Elimine los auriculares de su cuenta de Bose usando la aplicación Bose Music.

NOTA: Para más información sobre cómo eliminar los auriculares de su cuenta de Bose usando la aplicación Bose Music, visite: support.Bose.com/QCSE

3. Deslice el interruptor de encendido/*Bluetooth* ⌘ hacia la derecha y mantenga presionado. Al mismo tiempo, mantenga presionado el botón Acción por 30 segundos.

La luz de estado parpadea de color blanco. Después de 30 segundos, la luz de estado parpadea de color ámbar para indicar que se está restableciendo la configuración de fábrica (de 2 a 3 segundos).

4. Cuando se termina de restablecer, la luz de estado parpadea lentamente de color azul. Los auriculares ahora están en el estado de la configuración de fábrica original.

Lue ja säilytä kaikki turvallisuus- ja käyttöohjeet.

CE Bose Corporation vakuuttaa täten, että tämä tuote täyttää direktiivin 2014/53/EU sekä muiden sovellettavien EU-direktiivien vaatimukset. Täydellinen vaatimustenmukaisuusvakuutus on osoitteessa www.Bose.com/compliance.

UK CA Tämä tuote täyttää kaikki vuoden 2016 sähkömagneettista yhteensopivuutta koskevat vaatimukset ja muut sovellettavat Yhdistyneen kuningaskunnan vaatimukset. Täydellinen vaatimustenmukaisuusvakuutus on osoitteessa www.Bose.com/compliance.

Bose Corporation vakuuttaa täten, että tämä tuote noudattaa vuoden 2017 radiolaitesäännösten olennaisia vaatimuksia ja muita sovellettavia Yhdistyneen kuningaskunnan määräyksiä. Täydellinen vaatimustenmukaisuusvakuutus on osoitteessa www.Bose.com/compliance.

Tärkeitä turvallisuusohjeita

Älä käytä laitetta veden lähettyvillä.

Puhdista ainoastaan kuivalla liinalla.

Vain koulutettu huoltohenkilöstö saa tehdä huoltotyöt. Laite on huollettava, jos se vaurioituu millään tavalla. Huoltotarpeen aiheuttavia asioita ovat mm. seuraavat: virtajohto tai -pistoke on vaurioitunut, laitteen päälle on läikkyntä nestettä tai pudonnut esine, laite on kastunut tai kostunut, laite ei toimi normaalisti tai laite on pudonnut.

VAROITUKSET JA HUOMAUTUKSET

- ÄLÄ käytä kuulokkeita pitkään suurella äänenvoimakkuudella.
 - Säädä äänenvoimakkuus mukavaksi ja kohtuulliseksi, jotta vältät kuulovaurion.
 - Säädä äänenvoimakkuus pieneksi ennen kuin asetat kuulokkeet korviisi tai korvillesi. Lisää äänenvoimakkuutta vähitellen, kunnes löydät mukavan kuunteluvoimakkuuden.
- ÄLÄ käytä kuulokkeita ajaessasi puhelimessa puhumiseen tai muihin tarkoituksiin.
- ÄLÄ käytä kuulokkeita taustääänen poistotilassa, jos ulkopuolisten äänien kuulumattomuus voi vaarantaa sinut tai muut ihmiset. Tällaisia tilanteita ovat esimerkiksi pyöriminen tai käveleminen liikenteessä tai esimerkiksi liikenteen, rakennustyömaan tai rautatien lähellä. Noudata kuulokkeiden käyttöä koskevia lakeja.
 - Katkaise kuulokkeiden virta tai poista taustääänen poisto käytöstä ja säädä äänenvoimakkuus riittävän hiljaiseksi, jotta kuulet taustäänen, kuten hälytykset ja varoitukset.
 - Tutut muistutus- tai varoitusäänet voivat kuulostaa vierailta käyttäessäsi kuulokkeita, myös tietoisuustilassa.
- ÄLÄ käytä kuulokkeita, jos niistä kuuluu epätavallista, kovaa ääntä. Jos näin tapahtuu, katkaise kuulokkeista virta ja ota yhteyttä Bosen asiakaspalveluun.
- Ota kuulokkeet heti pois, jos tunnet niiden lämpenevän tai ääntä ei kuulu.
- ÄLÄ yhdistä kuulokkeita lentokoneen istuimen matkapuhelinlatausliitäntään. Ylikuumentuminen voi muutoin aiheuttaa palovamman tai muun henkilövahingon tai vaurioittaa kuulokkeita.
- ÄLÄ käytä kuulokkeita ilmailun viestintäkuulokkeina.



Laitteessa on pieniä osia. Ne voivat aiheuttaa tukehtumisvaaran. Ei sovellu alle 3-vuotiaiden lasten käytettäväksi.



Tuote sisältää magneettista materiaalia. Kysy lääkäriltä, voiko se vaikuttaa lääketieteellisen implantin toimintaan.

- ÄLÄ sijoita vuotavia, roiskuvia tai nesteitä sisältäviä esineitä, kuten maljakoita, laitteen päälle tai lähelle tulipalo- tai sähköiskuvaaran välttämiseksi.
- Pidä tuote etäällä avotulesta ja lämmönlähteistä. ÄLÄ laita laitteen päälle tai lähelle avotulta, esimerkiksi palavaa kynttilää.
- Käytä tuotetta vain hyväksytyllä LPS-virtalähteellä, joka vastaa paikallisia määräyksiä (esim. UL, CSA, VDE, CCC).
- ÄLÄ tee tuotteeseen muutoksia ilman lupaa.
- Jos akku vuotaa, älä päästä nestettä kosketuksiin ihon tai silmien kanssa. Jos näin kuitenkin tapahtuu, hakeudu lääkärin hoitoon.
- Älä altista akkua tai paristoja sisältäviä tuotteita liialliselle lämmölle (esim. suorasta auringonvalosta, avotulesta tms. aiheutuvalle lämmölle).
- ÄLÄ käytä kuulokkeita latauksen aikana.

HUOMAUTUS: Laite on testattu ja todettu luokan B digitaalilaitetta koskevien FCC:n sääntöjen osan 15 rajoitusten mukaiseksi. Nämä rajoitukset on tarkoitettu antamaan kohtuullinen suoja haitallisia häiriöitä vastaan kotiloissa. Laite tuottaa, käyttää ja voi säteillä energiaa radiotaajuudella, ja jos sitä ei ole asennettu tai käytetä ohjeiden mukaan, se voi aiheuttaa haitallista häiriötä radioliikenteelle. Kuitenkaan ei voida taata, ettei missään yksittäisessä asennuksessa aiheutuisi häiriöitä. Jos laite aiheuttaa radio- tai televisiovastaanotossa häiriöitä, jotka ovat helposti todettavissa kytkemällä laitteeseen virta ja sammuttamalla se, käyttäjän tulisi yrittää poistaa häiriöt seuraavilla toimenpiteillä:

- Suuntaa vastaanottava tuote tai antenni toisin tai siirrä se toiseen paikkaan.
- Siirrä laite ja vastaanotin kauemmas toisistaan.
- Kytke laite ja vastaanotin eri virtapiireissä oleviin pistorasioihin.
- Kysy neuvoa jälleenmyyjältä tai kokoneelta radio- tai tv-asentajalta.

Laitteeseen tehtävät Bose Corporationin hyväksymättömät muutokset voivat mitätöidä käyttäjälle annetun luvan käyttää tätä laitetta.

Laite täyttää FCC:n sääntöjen kohdan 15 ja ISED Canadan luvanvaraisuutta koskevat RSS-standardit. Käytön edellytyksenä on kaksi ehtoa: (1) Tämä laite ei saa aiheuttaa haitallisia häiriöitä. (2) Tämän laitteen täytyy ottaa vastaan kaikki häiriöt, mukaan lukien häiriöt, jotka saattavat aiheuttaa ei-toivottua toimintaa.

Laite täyttää yleiselle käytölle laaditut FCC- ja ISED Canada -säteilyrajoitusohjeet. Lähetintä ei saa sijoittaa toisen antennin tai lähettimen lähelle.

Täyttää IMDA-vaatimukset.

FCC ID: A94437310

IC: 3232A-437310

CAN ICES-3(B) / NMB-3(B)

Eurooppa:

Käytön taajuusalue 2 400–2 483,5 MHz.

Enimmäislähetysteho alle 20 dBm EIRP.

Enimmäislähetysteho on säännönmukaisia rajoja alhaisempi, joten SAR-testaus ei ole tarpeen ja siitä on vapautus sovellettavien säännösten mukaisesti.



Tämä symboli merkitsee, että tuotetta ei saa hävittää kotitalousjätteen mukana, vaan se on toimitettava kierrätykseen. Kierrättäminen auttaa estämään vahingollisia seurauksia ympäristölle, luonnolle ja ihmisten terveydelle. Saat lisätietoja kierrättämisestä paikallisilta viranomaisilta, kotitalousjätteen kierrätyspalvelusta tai liikkeestä, josta tuote ostettiin.

Pientehoisten radiotaajuuslaitteiden tekniset säännökset

Mikään yritys, yhtiö tai henkilö ei saa ilman NCC:n myöntämää lupaa muuttaa hyväksytyjen pientehoisten radiotaajuuslaitteiden taajuutta, parantaa niiden lähetystehoa tai muuttaa niiden alkuperäisiä ominaisuuksia tai suorituskykyä. Pientehoiset radiotaajuuslaitteet eivät saa vaikuttaa lentokoneiden turvallisuuteen eivätkä häiritä lakisääteistä viestiliikennettä. Jos tällaista todetaan, käyttäjän on lopetettava käyttö välittömästi, kunnes häiriötä ei enää ilmene. Mainitulla lakisääteisellä viestiliikenteellä tarkoitetaan televiestinnän hallinta-asetuksen mukaista radioviestiliikennettä. Pientehoisten radiotaajuuslaitteiden on otettava vastaan lakisääteisen viestiliikenteen tai ISM-radioaaltoja säteilevien laitteiden aiheuttamia häiriöitä.

ÄLÄ yritä poistaa ladattavaa litiumioniakku laitteesta. Jos akku on poistettava, ota yhteyttä lähimpään Bose-jälleenmyyjään tai muuhun pätevään ammattilaiseen.

Vain pätevä ammattilainen saa irrottaa ladattavan litiumioniakun tästä laitteesta. Lisätietoja saat paikalliselta Bose-jälleenmyyjältä tai osoitteesta products.bose.com/static/compliance/index.html.



Hävitä käytetyt akut ja paristot paikallisten viranomaisten ohjeiden mukaisesti. Ei saa polttaa.



Myrkyllisten tai vaarallisten aineiden tai alkuaineiden nimet ja sisältö						
Myrkylliset tai vaaralliset aineiden tai alkuaineet						
Osan nimi	Lyijy (Pb)	Elohopea (Hg)	Kadmium (Cd)	Kuusiarvoinen (CR(VI))	Polybrominoitu bifenyyl (PBB)	Polybrominoitu difenyylietteri (PBDE)
PCB-yhdisteet	X	0	0	0	0	0
Metalliosat	X	0	0	0	0	0
Muoviosat	0	0	0	0	0	0
Kaiutin	X	0	0	0	0	0
Johdot	X	0	0	0	0	0
Tämä taulukko on laadittu SJ/T 11364 -määräysten mukaisesti. O: Ilmaisee, että tätä myrkyllistä tai vaarallista ainetta on kaikissa tästä materiaalista valmistetuissa osissa alle GB/T 26572 -raja-arvon. X: Ilmaisee, että tätä myrkyllistä tai vaarallista ainetta on vähintään yhdessä tästä materiaalista valmistetussa osassa yli GB/T 26572 -raja-arvon.						

Valmistuspäivä: Sarjanumeron kahdeksas numero kertoo valmistusvuoden; 2 merkitsee vuotta 2012 tai 2022.

Maahantuoja Kiinassa: Bose Electronics (Shanghai) Company Limited, Level 6, Tower D, No. 2337 Gudai Rd. Minhong District, Shanghai 201100

Maahantuoja EU:ssa: Bose Products B.V., Gorslaan 60, 1441 RG Purmerend, The Netherlands

Maahantuoja Meksikossa: Bose de México S. de R.L. de C.V., Avenida Prado Sur #150, Piso 2, Interior 222 y 223, Colonia Lomas de Chapultepec V Sección, Miguel Hidalgo, Ciudad de México, C.P. 11000 Puhelinnumero: +5255 (5202) 3545

Maahantuoja Taiwanissa: Bose Limited Taiwan Branch (H.K.), 9F., No. 10, Sec. 3, Minsheng E. Road, Zhongshan Dist. Taipei City 10480, Taiwan Puhelinnumero: +886-2-2514 7676

Maahantuoja Yhdistyneessä kuningaskunnassa: Bose Limited, Bose House, Quayside Chatham Maritime, Chatham, Kent, ME4 4QZ, United Kingdom

Tuloarvot: 5 V --- 0,5 A

Latauslämpötila-alue: 0–45 °C

Purkauslämpötila-alue: -20–60 °C

Malli 437310. CMIIT-tunnus on korvakuvun sisäpuolella verkkokankaan alla.

Säilytä tiedot.

Sarja- ja mallinumerot ovat korvakuvun sisäpuolella verkkokankaan alla.

Sarjanumero: _____

Mallinumero: _____

Säilytä ostokuitti tämän käyttöohjeen välissä. Nyt on oikea aika rekisteröidä Bose-tuotteesi. Voit tehdä sen helposti osoitteessa worldwide.bose.com/ProductRegistration.

Turvallisuustiedot

Tämä tuote voi vastaanottaa Boselta turvallisuuspäivityksiä, kun se on yhdistetty Bose Music -sovellukseen. Jotta turvallisuuspäivitysten vastaanotto on mahdollista, tuotteen asennus Bose Music -sovelluksessa on suoritettava loppuun. **Jos määritystä ei suoriteta loppuun, käyttäjä on vastuussa Bosen tarjoamien turvallisuuspäivitysten asentamisesta osoitteesta btu.bose.com.**

Apple, Apple-logo, iPad, iPhone ja iPod ovat Apple Inc:n rekisteröityjä tavaramerkkejä Yhdysvalloissa ja muissa maissa. App Store on Apple Inc:n palvelumerkki. iPhone-tavaramerkkiä käytetään Japanissa Aiphone K.K:n lisenssillä.

Made for Apple -merkki tarkoittaa, että lisävaruste on suunniteltu liitettäväksi erityisesti merkissä kuvattuihin Apple-tuotteisiin ja että kehittäjä on sertifioinut sen täyttävän Applen vaatimukset. Apple ei vastaa tällaisen laitteen toiminnasta tai siitä, että se täyttää turvallisuusvaatimukset ja on määräysten mukainen.

Bluetooth[®]-sanamerkki ja -logot ovat Bluetooth SIG, Inc:n omistamia rekisteröityjä tavaramerkkejä, ja Bose Corporation käyttää niitä lisenssin nojalla.

Google Play on Google LLC:n tavaramerkki.

USB Type-C[®] ja USB-C[®] ovat USB Implementers Forumin rekisteröityjä tavaramerkkejä.

Bose, Bose Home Speaker, Bose Music, Bose Music -logo, Bose Smart Soundbar, Bose Smart Speaker, Bose Soundbar, QuietComfort ja SimpleSync ovat Bose Corporationin tavaramerkkejä.

Bose Corporationin pääkonttori: 1-877-230-5639

©2022 Bose Corporation. Mitään osaa tästä julkaisusta ei saa kopioida, muokata, jaella tai käyttää ilman julkaisijan etukäteen antamaa kirjallista lupaa.

The following license disclosures apply to certain third-party software packages used as components in the product.

Package: FreeRTOS

Copyright © Amazon Web Services, Inc. or its affiliates. All rights reserved.

The FreeRTOS package is subject to the license terms reprinted below:

MIT License

Permission is hereby granted, free of charge, to any person obtaining a copy of this software and associated documentation files (the "Software"), to deal in the Software without restriction, including without limitation the rights to use, copy, modify, merge, publish, distribute, sublicense, and/or sell copies of the Software, and to permit persons to whom the Software is furnished to do so, subject to the following conditions:

The above copyright notice and this permission notice shall be included in all copies or substantial portions of the Software.

THE SOFTWARE IS PROVIDED "AS IS", WITHOUT WARRANTY OF ANY KIND, EXPRESS OR IMPLIED, INCLUDING BUT NOT LIMITED TO THE WARRANTIES OF MERCHANTABILITY, FITNESS FOR A PARTICULAR PURPOSE AND NONINFRINGEMENT. IN NO EVENT SHALL THE AUTHORS OR COPYRIGHT HOLDERS BE LIABLE FOR ANY CLAIM, DAMAGES OR OTHER LIABILITY, WHETHER IN AN ACTION OF CONTRACT, TORT OR OTHERWISE, ARISING FROM, OUT OF OR IN CONNECTION WITH THE SOFTWARE OR THE USE OR OTHER DEALINGS IN THE SOFTWARE.

Package: Nanopb

Copyright © 2011 Petteri Aimonen <jpa at nanopb.mail.kapsi.fi>.

The Nanopb package is subject to the license terms reprinted below:

Zlib License

© 2011 Petteri Aimonen <jpa at nanopb.mail.kapsi.fi>

This software is provided 'as-is', without any express or implied warranty. In no event will the authors be held liable for any damages arising from the use of this software.

Permission is granted to anyone to use this software for any purpose, including commercial applications, and to alter it and redistribute it freely, subject to the following restrictions:

1. The origin of this software must not be misrepresented; you must not claim that you wrote the original software. If you use this software in a product, an acknowledgment in the product documentation would be appreciated but is not required.
2. Altered source versions must be plainly marked as such, and must not be misrepresented as being the original software.
3. This notice may not be removed or altered from any source distribution.

Package: Mbed TLS 2.16.1

© ARM Limited. All rights reserved.

The Mbed TLS package is subject to the license terms reprinted below:

Apache License

Version 2.0, January 2004

<http://www.apache.org/licenses/>

TERMS AND CONDITIONS FOR USE, REPRODUCTION, AND DISTRIBUTION

1. Definitions.
"License" shall mean the terms and conditions for use, reproduction, and distribution as defined by Sections 1 through 9 of this document.

“Licensor” shall mean the copyright owner or entity authorized by the copyright owner that is granting the License.

“Legal Entity” shall mean the union of the acting entity and all other entities that control, are controlled by, or are under common control with that entity. For the purposes of this definition, “control” means (i) the power, direct or indirect, to cause the direction or management of such entity, whether by contract or otherwise, or (ii) ownership of fifty percent (50%) or more of the outstanding shares, or (iii) beneficial ownership of such entity.

“You” (or “Your”) shall mean an individual or Legal Entity exercising permissions granted by this License.

“Source” form shall mean the preferred form for making modifications, including but not limited to software source code, documentation source, and configuration files.

“Object” form shall mean any form resulting from mechanical transformation or translation of a Source form, including but not limited to compiled object code, generated documentation, and conversions to other media types.

“Work” shall mean the work of authorship, whether in Source or Object form, made available under the License, as indicated by a copyright notice that is included in or attached to the work (an example is provided in the Appendix below).

“Derivative Works” shall mean any work, whether in Source or Object form, that is based on (or derived from) the Work and for which the editorial revisions, annotations, elaborations, or other modifications represent, as a whole, an original work of authorship. For the purposes of this License, Derivative Works shall not include works that remain separable from, or merely link (or bind by name) to the interfaces of, the Work and Derivative Works thereof.

“Contribution” shall mean any work of authorship, including the original version of the Work and any modifications or additions to that Work or Derivative Works thereof, that is intentionally submitted to Licensor for inclusion in the Work by the copyright owner or by an individual or Legal Entity authorized to submit on behalf of the copyright owner. For the purposes of this definition, “submitted” means any form of electronic, verbal, or written communication sent to the Licensor or its representatives, including but not limited to communication on electronic mailing lists, source code control systems, and issue tracking systems that are managed by, or on behalf of, the Licensor for the purpose of discussing and improving the Work, but excluding communication that is conspicuously marked or otherwise designated in writing by the copyright owner as “Not a Contribution.”

“Contributor” shall mean Licensor and any individual or Legal Entity on behalf of whom a Contribution has been received by Licensor and subsequently incorporated within the Work.

2. Grant of Copyright License. Subject to the terms and conditions of this License, each Contributor hereby grants to You a perpetual, worldwide, non-exclusive, no-charge, royalty-free, irrevocable copyright license to reproduce, prepare Derivative Works of, publicly display, publicly perform, sublicense, and distribute the Work and such Derivative Works in Source or Object form.
3. Grant of Patent License. Subject to the terms and conditions of this License, each Contributor hereby grants to You a perpetual, worldwide, non-exclusive, no-charge, royalty-free, irrevocable (except as stated in this section) patent license to make, have made, use, offer to sell, sell, import, and otherwise transfer the Work, where such license applies only to those patent claims licensable by such Contributor that are necessarily infringed by their Contribution(s) alone or by combination of their Contribution(s) with the Work to which such Contribution(s) was submitted. If You institute patent litigation against any entity (including a cross-claim or counterclaim in a lawsuit) alleging that the Work or a Contribution incorporated within the Work constitutes direct or contributory patent infringement, then any patent licenses granted to You under this License for that Work shall terminate as of the date such litigation is filed.
4. Redistribution. You may reproduce and distribute copies of the Work or Derivative Works thereof in any medium, with or without modifications, and in Source or Object form, provided that You meet the following conditions:
 - a. You must give any other recipients of the Work or Derivative Works a copy of this License; and
 - b. You must cause any modified files to carry prominent notices stating that You changed the files; and
 - c. You must retain, in the Source form of any Derivative Works that You distribute, all copyright, patent, trademark, and attribution notices from the Source form of the Work, excluding those notices that do not pertain to any part of the Derivative Works; and

d. If the Work includes a “NOTICE” text file as part of its distribution, then any Derivative Works that You distribute must include a readable copy of the attribution notices contained within such NOTICE file, excluding those notices that do not pertain to any part of the Derivative Works, in at least one of the following places: within a NOTICE text file distributed as part of the Derivative Works; within the Source form or documentation, if provided along with the Derivative Works; or, within a display generated by the Derivative Works, if and wherever such third-party notices normally appear. The contents of the NOTICE file are for informational purposes only and do not modify the License. You may add Your own attribution notices within Derivative Works that You distribute, alongside or as an addendum to the NOTICE text from the Work, provided that such additional attribution notices cannot be construed as modifying the License.

You may add Your own copyright statement to Your modifications and may provide additional or different license terms and conditions for use, reproduction, or distribution of Your modifications, or for any such Derivative Works as a whole, provided Your use, reproduction, and distribution of the Work otherwise complies with the conditions stated in this License.

5. Submission of Contributions. Unless You explicitly state otherwise, any Contribution intentionally submitted for inclusion in the Work by You to the Licensor shall be under the terms and conditions of this License, without any additional terms or conditions. Notwithstanding the above, nothing herein shall supersede or modify the terms of any separate license agreement you may have executed with Licensor regarding such Contributions.
6. Trademarks. This License does not grant permission to use the trade names, trademarks, service marks, or product names of the Licensor, except as required for reasonable and customary use in describing the origin of the Work and reproducing the content of the NOTICE file.
7. Disclaimer of Warranty. Unless required by applicable law or agreed to in writing, Licensor provides the Work (and each Contributor provides its Contributions) on an “AS IS” BASIS, WITHOUT WARRANTIES OR CONDITIONS OF ANY KIND, either express or implied, including, without limitation, any warranties or conditions of TITLE, NON-INFRINGEMENT, MERCHANTABILITY, or FITNESS FOR A PARTICULAR PURPOSE. You are solely responsible for determining the appropriateness of using or redistributing the Work and assume any risks associated with Your exercise of permissions under this License.
8. Limitation of Liability. In no event and under no legal theory, whether in tort (including negligence), contract, or otherwise, unless required by applicable law (such as deliberate and grossly negligent acts) or agreed to in writing, shall any Contributor be liable to You for damages, including any direct, indirect, special, incidental, or consequential damages of any character arising as a result of this License or out of the use or inability to use the Work (including but not limited to damages for loss of goodwill, work stoppage, computer failure or malfunction, or any and all other commercial damages or losses), even if such Contributor has been advised of the possibility of such damages.
9. Accepting Warranty or Additional Liability. While redistributing the Work or Derivative Works thereof, You may choose to offer, and charge a fee for, acceptance of support, warranty, indemnity, or other liability obligations and/or rights consistent with this License. However, in accepting such obligations, You may act only on Your own behalf and on Your sole responsibility, not on behalf of any other Contributor, and only if You agree to indemnify, defend, and hold each Contributor harmless for any liability incurred by, or claims asserted against, such Contributor by reason of your accepting any such warranty or additional liability.

END OF TERMS AND CONDITIONS

©2022 Bose Corporation

Licensed under the Apache License, Version 2.0 (the “License”); you may not use this file except in compliance with the License.

You may obtain a copy of the License at: <http://www.apache.org/licenses/LICENSE-2.0>

Unless required by applicable law or agreed to in writing, software distributed under the License is distributed on an “AS IS” BASIS, WITHOUT WARRANTIES OR CONDITIONS OF ANY KIND, either express or implied.

See the License for the specific language governing permissions and limitations under the License.

PAKKAUKSEN SISÄLTÖ

Sisältö	13
---------------	----

BOSE MUSIC -SOVELLUS

Bose Music -sovelluksen lataaminen	14
Kuulokkeiden lisääminen aiemmin luotuun tiliin.....	14

KUULOKKEIDEN SÄÄTIMET

Virran kytkeminen.....	16
Valmiustila-ajastin.....	16
Virran katkaiseminen	17
Kuulokkeiden toiminnot	18
Mediatoisto ja äänenvoimakkuus.....	18
Puhelut.....	19
Toimintopainike	20

TAUSTAÄÄNIEN POISTO

Taustaäänien poistotilat	21
Taustaäänien poistotilan vaihtaminen.....	21

ÄÄNIKOMENNOT

Äänikomentojen käyttäminen.....	22
---------------------------------	----

BLUETOOTH®-YHTEYDET

Yhdistäminen mobiililaitteen <i>Bluetooth</i> -valikosta	23
Mobiililaitteen yhteyden katkaiseminen.....	25
Mobiililaitteen yhdistäminen uudelleen.....	25
Toisen mobiililaitteen yhdistäminen	25
Yhdistettyjen mobiililaitteiden tunnistaminen.....	25
Kahden yhdistetyn mobiililaitteen välillä vaihtaminen.....	25
Yhdistäminen aiemmin yhdistettyyn laitteeseen	26
Kuulokkeiden laiteluettelon tyhjentäminen.....	26

JOHTOYHTEYDET

Yhdistäminen äänijohdolla	27
---------------------------------	----

AKKU

Kuulokkeiden akun lataaminen.....	28
Latausaika.....	28
Akun varaustason kuunteleminen	28

KUULOKKEIDEN TILA

<i>Bluetooth</i> -tila	29
Akun tila	29
Lataustila	30
Päivitys- ja virhetila	30

BOSE-TUOTTEIDEN YHDISTÄMINEN

Bose Smart Speakerin tai Soundbarin yhdistäminen	31
Edut.....	31
Yhteensopivat tuotteet	31
Yhteyden muodostaminen Bose Music -sovelluksella.....	31
Bose Smart Speakerin tai Soundbarin yhdistäminen uudelleen	32

HOITO JA KUNNOSSAPITO

Kuulokkeiden säilyttäminen.....	33
Kuulokkeiden puhdistaminen.....	34
Varaosat ja tarvikkeet.....	34
Rajoitettu takuu	34
Sarjanumeron sijainti	35

VIANMÄÄRITYS

Kokeile ensin näitä ratkaisuja	36
Muut ratkaisut.....	36
Kuulokkeiden tehdasetusten palauttaminen	39

SISÄLTÖ

Tarkista, että pakkaus sisältää seuraavat osat:



Bose QuietComfort 45 -kuulokkeet

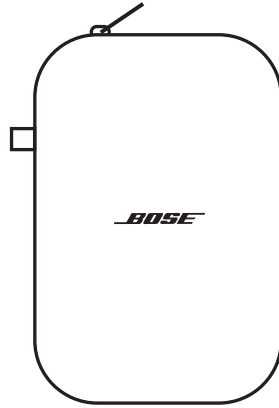

Pehmeä suojakotelo

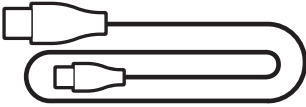

USB Type-C® -johto

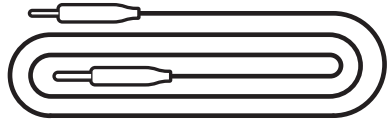

3,5 mm – 2,5 mm -äänijohto

HUOMAUTUS: Jos jokin tuotteen osa on vaurioitunut, älä käytä sitä. Ota yhteyttä valtuutettuun Bose-jälleenmyyjään tai Bosen asiakaspalveluun.

Käy osoitteessa support.bose.com/QCSE.

Bose Music -sovelluksen avulla voit määrittää kuulokkeiden asetukset ja ohjata niitä mobiililaitteella, kuten älypuhelimella tai taulutietokoneella.

Sovelluksessa voit esimerkiksi hallita *Bluetooth*-yhteyksiä ja kuulokkeiden asetuksia, valita äänikehoteen kielen ja saada uusia toimintoja päivitysten kautta.

HUOMAUTUS: Jos olet jo luonut Bose Music -tilin toista Bose-tuotetta varten, lisää kuulokkeet aiemmin luotuun tiliin (ks. sivu 14 alaosaa).

BOSE MUSIC -SOVELLUKSEN LATAAMINEN

1. Lataa Bose Music -sovellus mobiililaitteellesi.

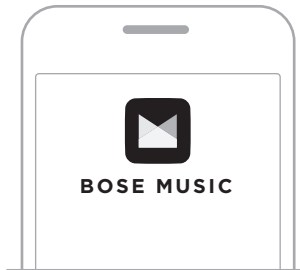

2. Noudata sovelluksen ohjeita.

KUULOKKEIDEN LISÄÄMINEN AIEMMIN LUOTUUN TILIIN

Lisää Bose QuietComfort 45 -kuulokkeet Bose Music -sovelluksessa.

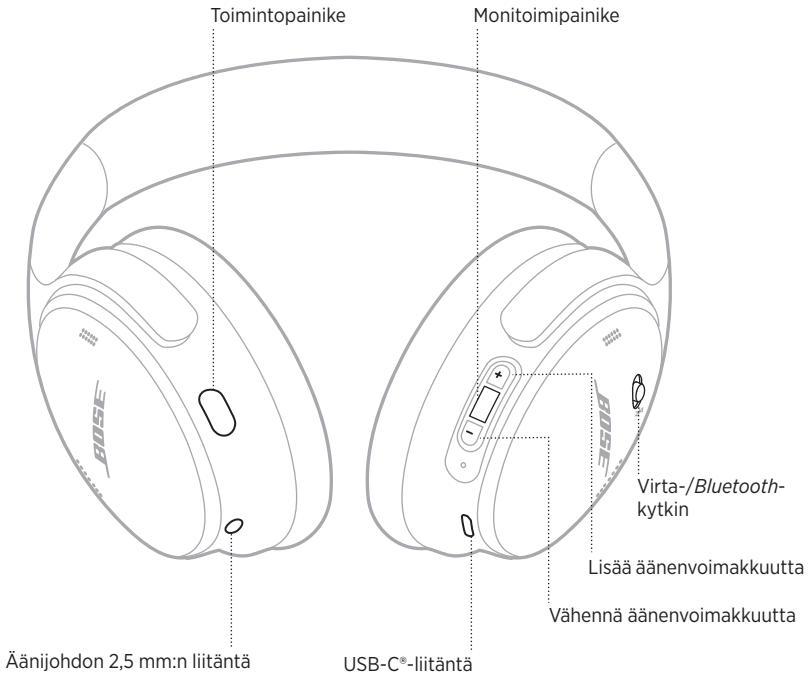

VIRRAN KYTKEMINEN

Vedä oikeassa korvakuvussa oleva virta-/Bluetooth-kytkin oikealle.

Kuulet akun varaustason, ja tilamerkkivalo palaa varaustason mukaan (ks. sivu 29).



Valmiustila-ajastin

Valmiustila-ajastin säästää akkua silloin kun kuulokkeita ei käytetä.

Voit määrittää ja muuttaa valmiustila-ajastimen asetuksia Bose Music -sovelluksessa.

VIRRRAN KATKAISEMINEN

Vedä virta-/Bluetooth-kytkin vasemmalle.



HUOMAUTUS: Kun kuulokkeiden virta on katkaistu, taustäänien poisto ei ole käytössä.

KUULOKKEIDEN TOIMINNOT

Kuulokkeiden säätimet sijaitsevat oikean korvakuvun takaosassa.

Mediatoisto ja äänenvoimakkuus

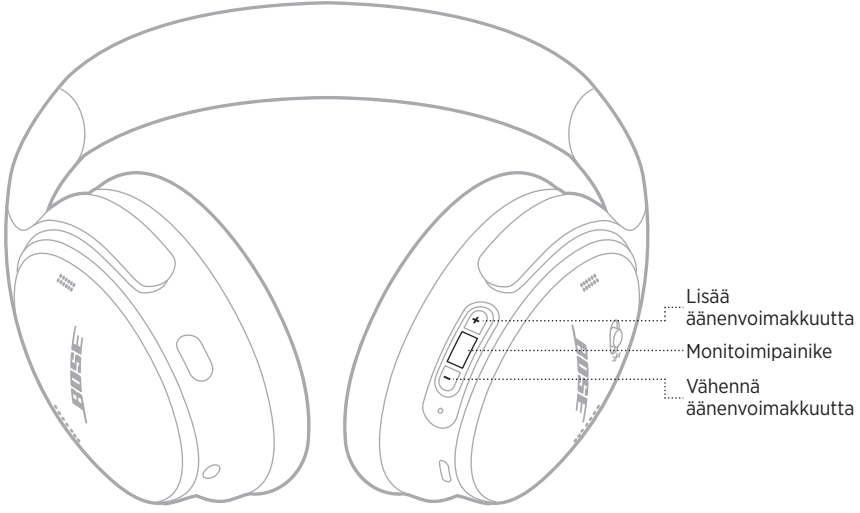

TOIMINTO	TOIMINTAOHJEET
Toisto/tauko	Paina monitoimipainiketta.
Siirtyminen eteenpäin	Paina monitoimipainiketta kahdesti.
Siirtyminen taaksepäin	Paina monitoimipainiketta kolme kertaa.
Lisää äänenvoimakkuutta	Paina +.
Vähennä äänenvoimakkuutta	Paina —.

HUOMAUTUKSIA:

- Voit lisätä äänenvoimakkuutta nopeasti pitämällä + painettuna.
- Voit vähentää äänenvoimakkuutta nopeasti pitämällä — painettuna.

Puhelut

Monitoimipainike sijaitsee oikean korvakuvun takaosassa. Mikrofoni on oikean korvakuvun etuosassa.

Toimintopainike sijaitsee vasemman korvakuvun takaosassa.

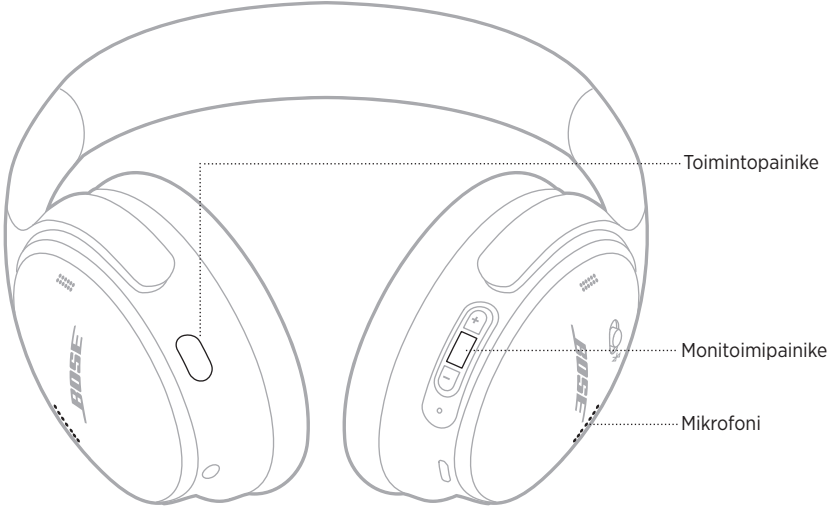

TOIMINTO	TOIMINTAOHJEET
Puheluun vastaaminen / puhelun päättäminen	Paina monitoimipainiketta.
Saapuvan puhelun hylkääminen	Pidä monitoimipainiketta painettuna yhden sekunnin ajan.
Toiseen puheluun vastaaminen ja ensimmäisen puhelun asettaminen pitoon	Kun toinen saapuva puhelu hälyttää puhelun aikana, paina monitoimipainiketta.
Toisen puhelun hylkääminen ja meneillään olevan puhelun jatkaminen	Kun toinen saapuva puhelu hälyttää puhelun aikana, pidä monitoimipainiketta painettuna yhden sekunnin ajan.
Vaihtaminen kahden puhelun välillä	Paina monitoimipainiketta kaksi kertaa, kun käynnissä on kaksi puhelua.
Puhelinneuvottelun aloittaminen	Kun käynnissä on kaksi puhelua, pidä monitoimipainiketta painettuna kolmen sekunnin ajan.
Puhelun mykistäminen ja mykistykseen poistaminen	Paina toimintopainiketta kaksi kertaa puhelun aikana.

Toimintopainike

Toimintopainikkeella voit vaihtaa taustäänien poistotilaa nopeasti ja helposti.

Toimintopainike sijaitsee vasemman korvakuvun takaosassa.



Voit vaihtaa hiljaisen tilan ja tietoisuustilan välillä painamalla toimintopainiketta.

Lisätietoja taustäänien poistotiloista, ks. sivu 21.

Taustaäänien poisto vaimentaa häiritseviä taustaääniä ja saa äänen kuulumaan selkeämpänä ja todenmukaisempana. Valittavaksi on kaksi taustaäänien poistotilaa: hiljainen tila ja tietoisuustila.

Hiljainen tila vaimentaa häiriöäänet tehokkaimmalla taustaäänien poistotasolla.

Tietoisuustilassa voit kuulla ympäristön äänet samalla, kun kuuntelet musiikkia.

Valitse taustaäänien poistotila omien kuuntelumieltyymystesi ja ympäristön mukaan.

TAUSTAÄÄNIEN POISTOTILAT

TILA	KUVAUS
Hiljainen tila	Huippuluokan taustaäänien poisto Bosen optimoimalla äänellä.
Tietoisuustila	Kuulet ympäristön äänet samalla, kun nautit musiikistasi.

HUOMAUTUS: Kun kuulokkeet käynnistyvät, käyttöön tulee viimeksi käytetty tila.

TAUSTAÄÄNIEN POISTOTILAN VAIHTAMINEN

Voit vaihtaa taustaäänien poistotilaa painamalla toimintopainiketta.

Kuulet äänikehotteen, joka kertoo valitun taustaäänien poistotilan.

VIHJE: Taustaäänien poistotilaa voi vaihtaa myös Bose Music -sovelluksella.

ÄÄNIKOMENTOJEN KÄYTTÄMINEN

Voit määrittää kuulokkeet käyttämään mobiililaitteen ääniohjausta. Ota äänikomennot käyttöön pitämällä monitoimipainiketta painettuna yhden sekunnin ajan.

Monitoimipainike sijaitsee oikean korvakuvun takaosassa.

HUOMAUTUS: Äänikomentoja ei voi käyttää puhelun aikana.

YHDISTÄMINEN MOBIILILAITTEEN *BLUETOOTH*-VALIKOSTA

Voit tallentaa enintään kahdeksan laitetta kuulokkeiden laiteluetteloon, ja kuulokkeet voivat olla aktiivisesti yhteydessä kahteen laitteeseen kerrallaan. Ääntä voi kuunnella vain yhdestä laitteesta kerrallaan.

HUOMAUTUS: Mobiililaitte kannattaa määrittää ja yhdistää Bose Music -sovelluksella (ks. sivu 14).

1. Vedä virta-/Bluetooth-kytkin oikealle ☞ ja pidä paikallaan kolme sekuntia.

Kuulet ilmoituksen "Valmis yhdistämään", ja tilamerkkivalo vilkkuu sinisenä.



2. Ota *Bluetooth*-ominaisuus käyttöön laitteessa.

HUOMAUTUS: *Bluetooth*-valikko sijaitsee yleensä Asetukset-valikossa.

3. Valitse kuulokkeet laiteluettelosta.

VIHJE: Etsi kuulokkeille antamasi nimi Bose Music -sovelluksesta. Jos et ole nimennyt kuulokkeita, näkyviin tulee oletusnimi.



Kun yhteys on muodostettu, kuulet ilmoituksen ”Yhdistetty laitteeseen <X>” ja tilamerkkivalo palaa sinisenä 10 sekuntia.

MOBIILILAITTEEN YHTEYDEN KATKAISEMINEN

Voit katkaista yhteyden mobiililaitteeseen Bose Music -sovelluksella.

VIHJE: Yhteyden voi katkaista myös *Bluetooth*-asetuksista. Kun poistat *Bluetooth*-ominaisuuden käytöstä, yhteys kaikkiin muihin laitteisiin katkaistaan.

MOBIILILAITTEEN YHDISTÄMINEN UUDELLEEN

Kun kuulokkeisiin kytketään virta, ne yrittävät muodostaa yhteyden kahteen viimeksi yhdistettynä olleeseen laitteeseen.

HUOMAUTUKSIA:

- Laitteiden on oltava enintään 9 metrin etäisyydellä, ja niiden virran tulee olla kytketty.
- Varmista, että *Bluetooth*-ominaisuus on otettu käyttöön mobiililaitteessa.

TOISEN MOBIILILAITTEEN YHDISTÄMINEN

Kun haluat yhdistää toisen laitteen, lataa Bose Music -sovellus (ks. sivu 14) tai käytä mobiililaitteen *Bluetooth*-valikkoa (ks. sivu 23).

HUOMAUTUS: Ääntä voi kuunnella vain yhdestä laitteesta kerrallaan.

YHDISTETTYJEN MOBIILILAITTEIDEN TUNNISTAMINEN

Voit kuunnella parhaillaan yhdistettynä olevan laitteen vetämällä virta-/*Bluetooth*-kytkimen ☒ oikealle ja vapauttamalla sen.

KAHDEN YHDISTETYN MOBIILILAITTEEN VÄLILLÄ VAIHTAMINEN

1. Pysäytä äänentoisto ensimmäisessä mobiililaitteessa.
2. Aloita äänentoisto toisessa mobiililaitteessa.

HUOMAUTUS: Kuulokkeet voivat vastaanottaa puheluja molemmista laitteista riippumatta siitä, kummasta laitteesta ääntä toistetaan.

YHDISTÄMINEN AIEMMIN YHDISTETTYYN LAITTEESEEN

1. Voit kuunnella yhdistettynä olevan laitteen vetämällä virta-/Bluetooth-kytkimen oikealle ☒ ja vapauttamalla sen.
2. Vetämällä virta-/Bluetooth-kytkimen kahden sekunnin kuluessa uudelleen oikealle ☒ ja vapauttamalla sen voit yhdistää kuulokkeiden laitepariluettelossa seuraavana olevaan laitteeseen.
3. Toista, kunnes kuulet oikean laitteen nimen.
Kuulet äänimerkin, kun laite on yhdistetty.
4. Aloita äänentoisto yhdistetyssä mobiililaitteessa.

HUOMAUTUS: Jos kuulokkeisiin on jo yhdistetty kaksi laitetta, uusi laite korvaa toisen aiemmin yhdistetyistä laitteista.

KUULOKKEIDEN LAITELUETTELON TYHJENTÄMINEN

1. Vedä virta-/Bluetooth-kytkin oikealle ☒ ja pidä paikallaan 15 sekuntia, kunnes kuulet ilmoituksen "Bluetooth-laiteluettelo tyhjennetty. Valmis yhdistämään."
2. Poista kuulokkeet mobiililaitteen Bluetooth-luettelosta.

Kaikkien laitteiden tiedot poistetaan kuulokkeiden muistista, ja kuulokkeet voidaan yhdistää.

YHDISTÄMINEN ÄÄNIJOHDOLLA

Toimitukseen sisältyvällä 2,5 mm – 3,5 mm -johdolla voit yhdistää kuulokkeet laitteeseen, jossa ei ole langatonta yhteyttä, tai käyttää kuulokkeita, kun niiden akku on tyhjä.

1. Liitä johto vasemman korvakuvun 2,5 mm:n liitäntään.



2. Liitä johdon toinen pää laitteen 3,5 mm:n liitäntään.

HUOMAUTUS: Äänijohdolla voit käyttää kuulokkeita niiden virran ollessa kytketty tai katkaistu.

KUULOKKEIDEN AKUN LATAAMINEN

1. Liitä USB-johdon pieni pää oikean korvakuvun USB-C-liitäntään.
2. Liitä toinen pää USB-seinälaturiin.



HUOMAUTUKSIA:

- Kun kuulokkeet alkavat latautua, tilamerkkivalo vilkkuu valkoisena 10 sekuntia. Kun akku on ladattu täyteen, tilamerkkivalo palaa valkoisena.
- Kuulokkeista ei kuulu ääntä, kun niitä ladataan.

Latausaika

Anna kuulokkeiden latautua täyteen kahden ja puolen tunnin ajan.

Akun varaustason kuunteleminen

Kun kytket kuulokkeisiin virran, kuuluu ilmoitus akun varaustasosta. Jos akun virta on vähissä, kuulet ilmoituksen "Akun varaustaso alhainen, lataa nyt".

HUOMAUTUS: Akun varaustason voi tarkistaa myös oikean korvakuvun merkkivalosta. Lisätietoja, ks. "Akun tila" sivulla 29.

Tilamerkkivalo on oikeassa korvakuvussa.



BLUETOOTH-TILA

Osoittaa *Bluetooth*-yhteyden tilan.

MERKKIVALON TOIMINTA	JÄRJESTELMÄN TILA
Vilkkuu sinisenä	Valmis yhdistämään
Palaa sinisenä (10 sekuntia)	Yhdistetty

AKUN TILA

Osoittaa akun varaustason.

MERKKIVALON TOIMINTA	JÄRJESTELMÄN TILA
Palaa valkoisena	Akku on ladattu puoliväliin tai täyteen.
Palaa oranssina	Akku on lähes tyhjä.

VIHJE: Voit tarkastaa akun varaustason myös Bose Music -sovelluksella.

LATAUSTILA

Osoittaa lataustilan.

MERKKIVALON TOIMINTA	JÄRJESTELMÄN TILA
Vilkkuu valkoisena kaksi kertaa	Lataus alkaa.
Palaa oranssina	Akku latautuu.
Palaa valkoisena	Akku ladattu täyteen.

PÄIVITYS- JA VIRHETILA

Osoittaa päivitys- tai virhetilan.

MERKKIVALON TOIMINTA	JÄRJESTELMÄN TILA
Vilkkuu nopeasti valkoisena (10 sekuntia)	Ohjelmistoa päivitetään (USB:n kautta).
Vilkkuu hitaasti valkoisena (30–60 sekuntia)	Ohjelmistoa päivitetään (langattomasti).
Vilkkuu oranssina ja valkoisena	Virhe. Ota yhteyttä Bosen asiakaspalveluun.

BOSE SMART SPEAKERIN TAI SOUNDBARIN YHDISTÄMINEN

SimpleSync™-tekniikan avulla voit yhdistää kuulokkeet Bose Smart Soundbariin tai Bose Smart Speakeriin ja saada yksilöllisiä kuuntelukokemuksia.

Edut

- Voit säätää kunkin tuotteen äänenvoimakkuutta erikseen tai mykistää Bose Smart Soundbarin ja pitää kuulokkeiden äänen niin lujalla kuin haluat.
- Voit kuunnella musiikkia selkeästi seuraavassa huoneessa, kun yhdistät kuulokkeet Bose Smart Speaker -kaiuttimeen.

HUOMAUTUS: SimpleSync™-tekniikan kantama on sama kuin *Bluetooth*-yhteyden, eli enintään 9 metriä. Seinät ja rakennusmateriaalit voivat vaikuttaa signaalinvälitykseen.

Yhteensopivat tuotteet

Kuulokkeet voi yhdistää mihin tahansa Bose Smart Speakeriin tai Bose Smart Soundbariin.

Suosittuja yhteensopivia tuotteita:

- Bose Smart Soundbar 700 / Bose Soundbar 700
- Bose Soundbar 500
- Bose Smart Speaker 500 / Bose Home Speaker 500
- Bose Home Speaker 300
- Bose Portable Smart Speaker / Bose Portable Home Speaker

Uusia tuotteita lisätään aika ajoin. Täydellinen lista ja lisätietoja on osoitteessa worldwide.Bose.com/Support/Groups.

Yhteyden muodostaminen Bose Music -sovelluksella

1. Vedä kuulokkeiden virta-/Bluetooth-kytkin oikealle ☒ ja pidä paikallaan kolme sekuntia.

Kuulet ilmoituksen "Valmis yhdistämään toiseen laitteeseen" ja tilamerkkivalo vilkkuu sinisenä.

2. Yhdistä kuulokkeet yhteensopivaan Bose-laitteeseen Bose Music -sovelluksella. Lisätietoja on osoitteessa worldwide.Bose.com/Support/Groups.

HUOMAUTUKSIA:

- Varmista, että kuulokkeet ovat enintään 9 metrin etäisyydellä soundbarista tai kaiuttimesta.
- Kuulokkeet voidaan yhdistää vain yhteen laitteeseen kerrallaan.

BOSE SMART SPEAKERIN TAI SOUNDBARIN YHDISTÄMINEN UUELLEEN

Kytke kuulokkeisiin virta (ks. ”Virran kytkeminen” sivulla 16).

Kuulokkeet yrittävät muodostaa yhteyden kahteen viimeksi yhdistettynä olleeseen *Bluetooth*-laitteeseen, kuten soundbariin tai kaiuttimeen.

HUOMAUTUKSIA:

- Soundbarin tai kaiuttimen on oltava enintään 9 metrin etäisyydellä, ja sen virran tulee olla kytketty.
- Jos yhteyden muodostaminen kuulokkeilla ei onnistu, katso ”Kuulokkeet eivät muodosta yhteyttä aiemmin yhdistettyyn Bose Smart Soundbariin tai Speakeriin.” sivulla 38.

KUULOKKEIDEN SÄILYTTÄMINEN

Korvakuvut voidaan kääntää, joten säilyttäminen on helppoa ja kätevää. Aseta kuulokkeet litteinä koteloon.

1. Käännä korvakuvut sisään siten, että ne ovat litteät.



2. Taita vasen korvakupu sankaa kohti.

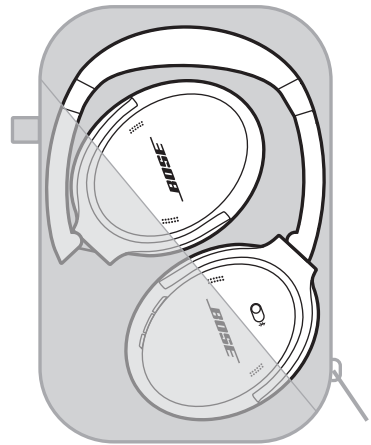
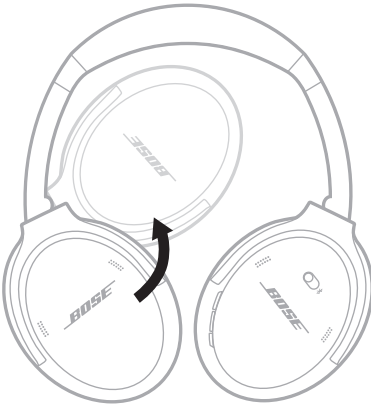

HUOMAUTUKSIA:

- Muista katkaista kuulokkeista virta, kun niitä ei käytetä.
- Jos kuulokkeet asetetaan säilytykseen muutamaa kuukautta pidemmäksi ajaksi, varmista, että niiden akku on ladattu täyteen.

KUULOKKEIDEN PUHDISTAMINEN

Pyyhi ulkopinnat pehmeällä, kuivalla liinalla.

Älä päästä kosteutta korvakupujen sisään.

VARAOSAT JA TARVIKKEET

Varaosia ja tarvikkeita voi tilata Bose-asiakaspalvelusta.

Käy osoitteessa support.Bose.com/QCSE.

RAJOITETTU TAKUU

Kuulokkeilla on rajoitettu takuu. Rajoitetusta takuusta on lisätietoja osoitteessa worldwide.Bose.com/Warranty.

Tuotteen rekisteröimisohjeet ovat osoitteessa worldwide.Bose.com/ProductRegistration. Rekisteröinnin laiminlyöminen ei vaikuta rajoitettuun takuuseen.

SARJANUMERON SIJAINTI

Sarjanumero on oikean korvakuvun sisäpuolella verkkokankaan alla. Verkkokangas on se sisäkangas, joka suojaa korvakuvun sisällä olevia osia.

Saat sarjanumeron näkyviin tarttumalla verkkokankaan yläreunaan ja irrottamalla kangasta varovasti.

HUOMIO: Varo painamasta tai irrottamasta korvakuvun sisällä olevia osia, jotta kuulokkeet eivät vaurioidu.

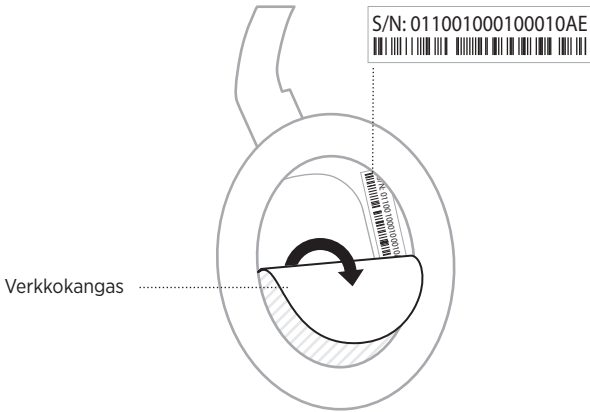

KOKEILE ENSIN NÄITÄ RATKAISUJA

Jos kuulokkeiden kanssa ilmenee ongelmia:

- Tarkasta tilamerkkivalo (ks. sivu 29).
- Lataa akku (ks. sivu 28).
- Lisää kuulokkeiden, mobiililaitteen ja musiikkisovelluksen äänenvoimakkuutta.
- Lataa Bose Music -sovellus ja suorita saatavilla olevat ohjelmistopäivitykset (ks. sivu 14).
- Kokeile yhdistää toinen mobiililaite (ks. sivu 25).

Jos ongelma ei ratkea, katso alla olevasta taulukosta tavallisimpien ongelmien oireet ja ratkaisut. Jos et löydä ratkaisua ongelmaan, ota yhteyttä Bosen asiakaspalveluun.

Käy osoitteessa worldwide.bose.com/contact.

MUUT RATKAISUT

OIRE	RATKAISU
Kuulokkeet eivät käynnisty.	Lataa akku.
Kuulokkeet eivät yhdistä mobiililaitteeseen.	<p>Irrota varaäänijohto.</p> <p>Irrota USB-latausjohto.</p> <p>Mobiililaitteessa:</p> <p>Poista <i>Bluetooth</i>-toiminto käytöstä ja ota se käyttöön uudelleen.</p> <p>Poista Bose QuietComfort 45 -kuulokkeet laitteen <i>Bluetooth</i>-luettelosta, myös kaksoiskappaleet, joissa on merkintä LE (Low Energy). Muodosta yhteys uudelleen.</p> <p>Siirrä mobiililaite lähemmäs kuulokkeita ja kauemmas häiriölähteestä tai esteestä.</p> <p>Opetusvideoita on osoitteessa support.bose.com/QCSE.</p> <p>Tyhjennä yhdistetyt laitteet (ks. sivu 26) ja muodosta yhteys uudelleen.</p>
Akku ei lataudu.	<p>Kytke USB-latausjohdon molemmat päät tukevasti.</p> <p>Kokeile toista latauslähdettä.</p> <p>Jos kuulokkeet ovat altistuneet korkealle tai matalalle lämpötilalle, anna niiden palautua huonelämpötilaan ja yritä sitten ladata ne uudelleen.</p>

OIRE	RATKAISU
Ääntä ei kuulu.	<p>Kytke kuulokkeisiin virta ja lataa akku.</p> <p>Tarkasta tilamerkkivalo (ks. sivu 29).</p> <p>Vedä virta-/Bluetooth-kytkin oikealle ja vapauta se, niin kuulet liitetyn laitteen nimen. Varmista, että käytät oikeaa laitetta.</p> <p>Siirrä mobiililaitte lähemmäs kuulokkeita ja kauemmas häiriölähteestä tai esteestä.</p> <p>Käytä toista musiikkilähdettä.</p> <p>Jos kuulokkeisiin on yhdistetty kaksi mobiililaitetta, aseta ensin toinen niistä taukotilaan.</p> <p>Jos kuulokkeisiin on yhdistetty kaksi mobiililaitetta, siirrä laitteen kuulokkeiden kantoalueelle (9 m).</p> <p>Kokeile mobiililaitteeseen tallennettua musiikkia tai videotiedostoa.</p>
Äänenlaatu on huono.	<p>Käytä toista musiikkilähdettä.</p> <p>Yhdistä toinen mobiililaitte (ks. sivu 25).</p> <p>Katkaise yhteys toiseen laitteeseen.</p> <p>Siirrä mobiililaitte lähemmäs kuulokkeita ja kauemmas häiriölähteestä tai esteestä.</p> <p>Kokeile mobiililaitteeseen tallennettua musiikkia tai videotiedostoa.</p>
Äänijohdolla yhdistetystä laitteesta ei kuulu ääntä.	<p>Kytke varaäänijohdon molemmat päät tukevasti.</p> <p>Lisää kuulokkeiden, mobiililaitteen ja musiikkilähteen äänenvoimakkuutta.</p> <p>Yhdistä toinen laite (ks. sivu 25).</p>
Äänijohdolla yhdistetystä laitteesta kuuluva ääni on huono.	<p>Kytke varaäänijohdon molemmat päät tukevasti.</p> <p>Yhdistä toinen laite (ks. sivu 25).</p>
Toimintopainike ei muuta taustaäänien poistotilaa.	<p>Varmista, että kuulokkeisiin on kytketty virta.</p> <p>Vaihda taustaäänien poistotilaa Bose Music -sovelluksella.</p>

OIRE	RATKAISU
Kuulokkeet eivät muodosta yhteyttä Bose Smart Soundbariin tai Speakeriin.	Vedä virta-/ <i>Bluetooth</i> -painiketta ja pidä se paikallaan, kunnes kuulet ilmoituksen ”Valmis yhdistämään toisen laitteen” ja <i>Bluetooth</i> -merkkivalo vilkkuu sinisenä. Varmista, että kuulokkeet ovat enintään 9 metrin etäisyydellä soundbarista tai kaiuttimesta.
Kuulokkeet eivät muodosta yhteyttä aiemmin yhdistettyyn Bose Smart Soundbariin tai Speakeriin.	Yhdistä aiemmin yhdistettyyn laitteeseen (ks. sivu 26).
Äänessä on viivettä, kun kuulokkeet on yhdistetty Bose Smart Soundbariin tai Speakeriin.	Lataa Bose Music -sovellus ja suorita käytettävissä olevat ohjelmistopäivitykset.

Tehdasasetusten palautuksella voit tyhjentää kaikki asetukset ja palauttaa kuulokkeet niiden alkuperäiseen tilaan. Sen jälkeen kuulokkeet voi määrittää uudelleen samalla tavalla kuin ensimmäisellä kerralla.

Tehdasasetusten palauttaminen on suositeltavaa vain silloin kun kuulokkeiden kanssa on ongelmia tai Bosen asiakaspalvelu kehottaa tekemään niin.

KUULOKKEIDEN TEHDASASETUSTEN PALAUTTAMINEN

1. Poista kuulokkeet laitteen *Bluetooth*-luettelosta.
2. Poista kuulokkeet Bose-tililtäsi Bose Music -sovelluksella.

HUOMAUTUS: Lisätietoja kuulokkeiden poistamisesta Bose-tililtä Bose Music -sovelluksella on osoitteessa support.bose.com/QCSE.

3. Vedä virta-/*Bluetooth*-kytkin oikealle ☒ ja pidä paikallaan. Paina samalla toimintopainiketta ja pidä se painettuna 30 sekunnin ajan.

Tilamerkkivalo vilkkuu valkoisena. Kun 30 sekuntia on kulunut, tilamerkkivalo alkaa vilkkua oranssina merkiksi siitä, että tehdasasetuksia palautetaan (2-3 sekuntia).

4. Kun palautus on valmis, tilamerkkivalo vilkkuu hitaasti sinisenä. Kuulokkeet ovat nyt alkuperäisessä tilassa.

Lisez et conservez à portée de main toutes les consignes de sécurité et le mode d'emploi.

CE Bose Corporation déclare que ce produit est conforme aux critères essentiels et autres dispositions de la directive 2014/53/UE et des autres directives européennes applicables. L'attestation complète de conformité est disponible à l'adresse www.Bose.com/compliance

**UK
CA** Ce produit est conforme à toutes les réglementations de 2016 en matière de compatibilité électromagnétique et à toutes les autres réglementations britanniques applicables. L'attestation complète de conformité est disponible à l'adresse www.Bose.com/compliance

Bose Corporation déclare que ce produit est conforme aux critères essentiels et autres dispositions des réglementations de 2017 sur les équipements radio et des autres réglementations britanniques applicables. L'attestation complète de conformité est disponible à l'adresse www.Bose.com/compliance

Instructions importantes relatives à la sécurité

N'utilisez pas cet appareil à proximité de l'eau ou d'une source d'humidité.

Utilisez uniquement un chiffon sec pour le nettoyage.

Confiez toute réparation à du personnel qualifié. Une réparation est nécessaire lorsque l'appareil a été endommagé de quelque façon que ce soit (endommagement du câble d'alimentation ou de la fiche électrique, renversement d'un liquide ou de tout objet sur l'appareil, exposition de l'appareil à la pluie ou à l'humidité, dysfonctionnement, chute de l'appareil, etc.).

AVERTISSEMENTS/PRÉCAUTIONS

- Veillez à NE PAS utiliser le casque/les écouteurs à un volume élevé pendant une période prolongée.
 - Pour éviter des dommages auditifs, utilisez votre casque/vos écouteurs à un volume confortable, mais modéré.
 - Baissez le volume de l'appareil avant de placer le casque sur les oreilles, puis augmentez le volume progressivement jusqu'à ce que le niveau d'écoute vous convienne.
- Veillez à NE PAS utiliser le casque pendant que vous conduisez un véhicule pour passer ou recevoir des appels.
- Veillez à NE PAS utiliser le casque avec le mode de réduction des bruits ambiants activé si le fait de ne pas entendre les bruits environnants peut vous mettre en danger ou mettre en danger d'autres personnes, notamment lorsque vous faites de la bicyclette, vous promenez près d'une route fréquentée, d'un chantier, d'une ligne de chemin de fer, etc., et veillez à toujours respecter les lois applicables relatives à l'utilisation d'un casque.
 - Éteignez le casque ou utilisez-le après avoir désactivé la fonction de réduction des bruits, puis réglez le volume de façon à pouvoir entendre les bruits environnants, notamment les alarmes et les signaux d'avertissement.
 - Rappel important : les sons que vous identifiez normalement comme rappels ou avertissements peuvent varier lorsque vous utilisez le casque, même lorsque le mode Attentif est activé.
- Veillez à NE PAS utiliser le casque/les écouteurs s'ils émettent un son anormalement élevé. Le cas échéant, éteignez le casque/les écouteurs et contactez le service client de Bose.
- Si vous ressentez de la chaleur ou une perte de signal audio, retirez immédiatement le casque/les écouteurs.
- Veillez à NE PAS utiliser les adaptateurs pour téléphone portable pour connecter le casque/les écouteurs au système audio des cabines d'avion. Le dégagement de chaleur qui en résulterait est susceptible de provoquer des brûlures ou d'endommager le casque/les écouteurs.
- Veillez à NE PAS utiliser le casque comme dispositif de communication d'aviation.



Certaines pièces présentent un risque de suffocation. Ne les laissez pas à la portée des enfants de moins de 3 ans.



Ce produit contient des composants magnétiques. Consultez votre médecin afin de savoir si ces composants peuvent avoir une incidence sur un dispositif médical implantable.

- Pour réduire le risque d'incendie ou de secousse électrique, veillez à ne PAS exposer ce produit à la pluie, au ruissellement, aux éclaboussures ou à l'humidité, et à ne jamais placer d'objets contenant des liquides, notamment des vases, sur l'appareil ou à proximité.
- Tenez le produit à l'écart du feu et des sources de chaleur. Veillez à NE PAS placer d'objets enflammés, tels que des bougies allumées, sur l'appareil ou à proximité.
- Utilisez ce produit uniquement avec un adaptateur secteur LPS certifié conforme aux réglementations en vigueur (p. ex., UL, CSA, VDE, CCC).
- Veillez à NE PAS effectuer de modifications non autorisées sur ce produit.
- En cas de fuite, évitez tout contact du liquide avec la peau ou les yeux. En cas de contact, consultez immédiatement un médecin.
- N'exposez pas les produits contenant des piles ou des batteries à une chaleur excessive (ne les placez pas à la lumière directe du soleil, près d'un feu ou de toute autre source de chaleur).
- Veillez à NE PAS porter le casque pendant la charge.

REMARQUE : cet appareil a fait l'objet de tests prouvant sa conformité aux limites imposées aux appareils numériques de classe B, conformément à la partie 15 de la réglementation de la FCC. Ces limites sont conçues pour offrir une protection raisonnable contre les interférences nuisibles dans une installation résidentielle. Cet appareil génère, utilise et est susceptible d'émettre de l'énergie radioélectrique. À ce titre, s'il n'est pas installé ou utilisé conformément aux instructions, il est susceptible de perturber les communications radio. Cependant, il n'est nullement garanti que de telles perturbations ne se produisent pas dans une installation donnée. Si cet appareil perturbe effectivement la réception de la radio ou de la télévision (ce qui peut être vérifié en allumant et en éteignant l'appareil), vous êtes invité à tenter de remédier au problème en prenant une ou plusieurs des mesures suivantes :

- Réorientez ou déplacez le produit récepteur ou l'antenne.
- Augmentez la distance séparant le matériel du récepteur.
- Connectez l'appareil à une prise reliée à un circuit différent de celui auquel est branché l'amplificateur.
- Consultez votre revendeur ou un technicien radio/TV expérimenté pour obtenir de l'aide.

Toute modification non autorisée expressément par Bose Corporation est susceptible d'annuler le droit de l'utilisateur d'utiliser cet appareil.

Cet appareil est conforme à la partie 15 de la réglementation de la FCC et à ou aux standards RSS exemptés de licence du ministère de l'Innovation, des Sciences et du Développement économique (ISDE) du Canada. L'utilisation de cet appareil est soumise aux conditions suivantes : (1) cet appareil ne doit pas provoquer d'interférences et (2) il doit tolérer les interférences externes, y compris celles susceptibles de provoquer un dysfonctionnement.

Cet appareil est conforme aux réglementations de la FCC et d'ISDE Canada relatives aux limites d'exposition aux rayonnements électromagnétiques pour le grand public. Il ne doit pas être installé ni utilisé avec un autre émetteur radio ou son antenne.

Cet appareil est conforme aux normes IMDA.

ID FCC : A94437310

IC : 3232A-437310

CAN ICES-3(B)/NMB-3(B)

Pour l'Europe,

Bande de fréquences comprise entre 2 400 et 2 483,5 MHz.

Puissance de transmission maximale inférieure à 20 dBm P.I.R.E.

La puissance de transmission maximale est inférieure aux limites réglementaires. Par conséquent, le test du DAS n'est pas nécessaire et on en est dispensé conformément aux réglementations en vigueur.



Ce symbole signifie que le produit ne doit pas être jeté avec les déchets ménagers, mais déposé dans un centre de collecte approprié pour recyclage. Une mise au rebut et un recyclage adéquats permettent de protéger les ressources naturelles, la santé humaine et l'environnement. Pour plus d'informations sur la mise au rebut et le recyclage de ce produit, contactez votre mairie, votre service de ramassage des ordures ou le magasin où vous l'avez acheté.

Règles techniques relatives aux appareils à radiofréquences de faible puissance

En l'absence d'autorisation de la NCC, les organisations, entreprises ou utilisateurs ne sont pas autorisés à modifier la fréquence, à améliorer la puissance de transmission ou à altérer les caractéristiques d'origine et les performances d'un appareil à radiofréquences de faible puissance approuvé. Les appareils à radiofréquences de faible puissance ne doivent avoir aucune incidence sur la sécurité des avions ni provoquer d'interférences avec les communications légales ; dans le cas contraire, l'utilisateur devra immédiatement cesser d'utiliser l'appareil jusqu'à l'absence complète d'interférences. Par communications légales, nous entendons les communications radio établies conformément au Telecommunications Management Act. Les appareils à radiofréquences de faible puissance peuvent être sensibles aux interférences des communications légales ou aux appareils émettant des ondes radio ISM.

N'essayez PAS d'extraire la batterie rechargeable lithium-ion de ce produit. Pour la retirer, contactez votre revendeur Bose local ou un technicien qualifié.

Le retrait de la batterie lithium-ion rechargeable de cet appareil doit être confié à un technicien qualifié. Contactez votre revendeur Bose local ou consultez le site products.bose.com/static/compliance/index.html pour en savoir plus.



Mettez au rebut les piles usagées conformément aux réglementations locales. Ne les incinérez pas.



Noms et quantités des substances ou éléments toxiques ou dangereux						
Nom	Substances ou éléments toxiques ou dangereux					
	Plomb (Pb)	Mercure (Hg)	Cadmium (Cd)	Chrome hexavalent (CR(VI))	Biphényle polybromé (PBB)	Éther de diphenyle polybromé (PBDE)
Cartes de circuits imprimés	X	0	0	0	0	0
Pièces métalliques	X	0	0	0	0	0
Pièces en plastique	0	0	0	0	0	0
Enceinte	X	0	0	0	0	0
Câbles	X	0	0	0	0	0
Les données de ce tableau sont conformes aux dispositions de la norme SJ/T 11364. 0 : indique que la quantité de cette substance toxique ou dangereuse contenue dans tous les composants homogènes de cette pièce est inférieure à la limite définie dans GB/T 26572. X : indique que la quantité de cette substance toxique ou dangereuse contenue dans au moins un des composants homogènes de cette pièce est supérieure à la limite définie dans GB/T 26572.						

Date de fabrication : le huitième chiffre du numéro de série indique l'année de fabrication ; par exemple, « 2 » correspond à 2012 ou à 2022.

Importateur pour la Chine : Bose Electronics (Shanghai) Company Limited, Level 6, Tower D, No. 2337 Gudai Rd. Minhang District, Shanghai 201100

Importateur pour l'UE : Bose Products B.V., Gorslaan 60, 1441 RG Purmerend, Pays-Bas

Importateur pour le Mexique : Bose de México S. de R.L. de C.V., Avenida Prado Sur #150, Piso 2, Interior 222 y 223, Colonia Lomas de Chapultepec V Sección, Miguel Hidalgo, Ciudad de México, C.P. 11000
 Numéro de téléphone : +5255 (5202) 3545

Importateur pour Taïwan : Bose Limited Taiwan Branch (H.K.), 9F., No. 10, Sec. 3, Minsheng E. Road, Zhongshan Dist. Taipei City 10480, Taïwan Numéro de téléphone : +886-2-2514 7676

Importateur pour le Royaume-Uni : Bose Limited, Bose House, Quayside Chatham Maritime, Chatham, Kent, ME4 4QZ, Royaume-Uni

Puissance en entrée : 5 V --- 0,5 A

Plage de températures lors de la charge : 0 °C à 45 °C

Plage de températures lors de la décharge : -20 °C à 60 °C

Modèle 437310. L'ID CMIIT se trouve à l'intérieur de l'écouteur, sous le canevas.

Renseignements à noter et conserver

Le numéro de série et le numéro de modèle se trouvent à l'intérieur de l'écouteur, sous le canevas.

Numéro de série : _____

Numéro de modèle : _____

Conservez votre facture avec la notice d'utilisation. Enregistrez dès maintenant votre produit Bose. Pour ce faire, rendez-vous sur worldwide.bose.com/ProductRegistration

Informations relatives à la sécurité

Ce produit peut recevoir des mises à jour automatiques de Bose lorsqu'il est connecté à l'application Bose Music. Pour recevoir des mises à jour de sécurité via l'application mobile, vous devez terminer le processus de configuration du produit dans l'application Bose Music. **Si vous ne procédez pas ainsi, il vous incombe d'installer les mises à jour de sécurité que Bose met à votre disposition via btu.Bose.com**

Apple, le logo Apple, iPad, iPhone et iPod sont des marques de commerce d'Apple Inc., déposées aux États-Unis et dans d'autres pays. App Store est une marque de service d'Apple Inc. La marque de commerce « iPhone » est utilisée au Japon sous licence d'Aiphone K.K.

L'utilisation de la mention « Made for Apple » signifie qu'un accessoire a été conçu pour se connecter spécifiquement à un ou plusieurs produits Apple identifiés, et que son fabricant certifie la conformité avec les standards de performances d'Apple. La société Apple décline toute responsabilité relative au fonctionnement de cet appareil ou à sa conformité aux normes de sécurité.

L'appellation et les logos *Bluetooth*[®] sont des marques déposées de Bluetooth SIG, Inc., utilisées sous licence par Bose Corporation.

Google Play est une marque commerciale de Google LLC.

USB Type-C[®] et USB-C[®] sont des marques déposées de USB Implementers Forum.

Bose, Bose Home Speaker, Bose Music, le logo Bose Music, Bose Smart Soundbar, Bose Smart Speaker, Bose Soundbar, QuietComfort et SimpleSync sont des marques de commerce de Bose Corporation.

Siège de Bose Corporation : 1-877-230-5639

©2022 Bose Corporation. Toute reproduction, modification, distribution ou autre utilisation, même partielle, de ce document est interdite sans autorisation écrite préalable.

The following license disclosures apply to certain third-party software packages used as components in the product.

Package: FreeRTOS

Copyright © Amazon Web Services, Inc. or its affiliates. All rights reserved.

The FreeRTOS package is subject to the license terms reprinted below:

MIT License

Permission is hereby granted, free of charge, to any person obtaining a copy of this software and associated documentation files (the “Software”), to deal in the Software without restriction, including without limitation the rights to use, copy, modify, merge, publish, distribute, sublicense, and/or sell copies of the Software, and to permit persons to whom the Software is furnished to do so, subject to the following conditions:

The above copyright notice and this permission notice shall be included in all copies or substantial portions of the Software.

THE SOFTWARE IS PROVIDED “AS IS”, WITHOUT WARRANTY OF ANY KIND, EXPRESS OR IMPLIED, INCLUDING BUT NOT LIMITED TO THE WARRANTIES OF MERCHANTABILITY, FITNESS FOR A PARTICULAR PURPOSE AND NONINFRINGEMENT. IN NO EVENT SHALL THE AUTHORS OR COPYRIGHT HOLDERS BE LIABLE FOR ANY CLAIM, DAMAGES OR OTHER LIABILITY, WHETHER IN AN ACTION OF CONTRACT, TORT OR OTHERWISE, ARISING FROM, OUT OF OR IN CONNECTION WITH THE SOFTWARE OR THE USE OR OTHER DEALINGS IN THE SOFTWARE.

Package: Nanopb

Copyright © 2011 Petteri Aimonen <jpa at nanopb.mail.kapsi.fi>.

The Nanopb package is subject to the license terms reprinted below:

Zlib License

© 2011 Petteri Aimonen <jpa at nanopb.mail.kapsi.fi>

This software is provided ‘as-is’, without any express or implied warranty. In no event will the authors be held liable for any damages arising from the use of this software.

Permission is granted to anyone to use this software for any purpose, including commercial applications, and to alter it and redistribute it freely, subject to the following restrictions:

1. The origin of this software must not be misrepresented; you must not claim that you wrote the original software. If you use this software in a product, an acknowledgment in the product documentation would be appreciated but is not required.
2. Altered source versions must be plainly marked as such, and must not be misrepresented as being the original software.
3. This notice may not be removed or altered from any source distribution.

Package: Mbed TLS 2.16.1

© ARM Limited. All rights reserved.

The Mbed TLS package is subject to the license terms reprinted below:

Apache License

Version 2.0, January 2004

<http://www.apache.org/licenses/>

TERMS AND CONDITIONS FOR USE, REPRODUCTION, AND DISTRIBUTION

1. Definitions.
“License” shall mean the terms and conditions for use, reproduction, and distribution as defined by Sections 1 through 9 of this document.

“Licensor” shall mean the copyright owner or entity authorized by the copyright owner that is granting the License.

“Legal Entity” shall mean the union of the acting entity and all other entities that control, are controlled by, or are under common control with that entity. For the purposes of this definition, “control” means (i) the power, direct or indirect, to cause the direction or management of such entity, whether by contract or otherwise, or (ii) ownership of fifty percent (50%) or more of the outstanding shares, or (iii) beneficial ownership of such entity.

“You” (or “Your”) shall mean an individual or Legal Entity exercising permissions granted by this License.

“Source” form shall mean the preferred form for making modifications, including but not limited to software source code, documentation source, and configuration files.

“Object” form shall mean any form resulting from mechanical transformation or translation of a Source form, including but not limited to compiled object code, generated documentation, and conversions to other media types.

“Work” shall mean the work of authorship, whether in Source or Object form, made available under the License, as indicated by a copyright notice that is included in or attached to the work (an example is provided in the Appendix below).

“Derivative Works” shall mean any work, whether in Source or Object form, that is based on (or derived from) the Work and for which the editorial revisions, annotations, elaborations, or other modifications represent, as a whole, an original work of authorship. For the purposes of this License, Derivative Works shall not include works that remain separable from, or merely link (or bind by name) to the interfaces of, the Work and Derivative Works thereof.

“Contribution” shall mean any work of authorship, including the original version of the Work and any modifications or additions to that Work or Derivative Works thereof, that is intentionally submitted to Licensor for inclusion in the Work by the copyright owner or by an individual or Legal Entity authorized to submit on behalf of the copyright owner. For the purposes of this definition, “submitted” means any form of electronic, verbal, or written communication sent to the Licensor or its representatives, including but not limited to communication on electronic mailing lists, source code control systems, and issue tracking systems that are managed by, or on behalf of, the Licensor for the purpose of discussing and improving the Work, but excluding communication that is conspicuously marked or otherwise designated in writing by the copyright owner as “Not a Contribution.”

“Contributor” shall mean Licensor and any individual or Legal Entity on behalf of whom a Contribution has been received by Licensor and subsequently incorporated within the Work.

2. Grant of Copyright License. Subject to the terms and conditions of this License, each Contributor hereby grants to You a perpetual, worldwide, non-exclusive, no-charge, royalty-free, irrevocable copyright license to reproduce, prepare Derivative Works of, publicly display, publicly perform, sublicense, and distribute the Work and such Derivative Works in Source or Object form.
3. Grant of Patent License. Subject to the terms and conditions of this License, each Contributor hereby grants to You a perpetual, worldwide, non-exclusive, no-charge, royalty-free, irrevocable (except as stated in this section) patent license to make, have made, use, offer to sell, sell, import, and otherwise transfer the Work, where such license applies only to those patent claims licensable by such Contributor that are necessarily infringed by their Contribution(s) alone or by combination of their Contribution(s) with the Work to which such Contribution(s) was submitted. If You institute patent litigation against any entity (including a cross-claim or counterclaim in a lawsuit) alleging that the Work or a Contribution incorporated within the Work constitutes direct or contributory patent infringement, then any patent licenses granted to You under this License for that Work shall terminate as of the date such litigation is filed.
4. Redistribution. You may reproduce and distribute copies of the Work or Derivative Works thereof in any medium, with or without modifications, and in Source or Object form, provided that You meet the following conditions:
 - a. You must give any other recipients of the Work or Derivative Works a copy of this License; and
 - b. You must cause any modified files to carry prominent notices stating that You changed the files; and
 - c. You must retain, in the Source form of any Derivative Works that You distribute, all copyright, patent, trademark, and attribution notices from the Source form of the Work, excluding those notices that do not pertain to any part of the Derivative Works; and

d. If the Work includes a “NOTICE” text file as part of its distribution, then any Derivative Works that You distribute must include a readable copy of the attribution notices contained within such NOTICE file, excluding those notices that do not pertain to any part of the Derivative Works, in at least one of the following places: within a NOTICE text file distributed as part of the Derivative Works; within the Source form or documentation, if provided along with the Derivative Works; or, within a display generated by the Derivative Works, if and wherever such third-party notices normally appear. The contents of the NOTICE file are for informational purposes only and do not modify the License. You may add Your own attribution notices within Derivative Works that You distribute, alongside or as an addendum to the NOTICE text from the Work, provided that such additional attribution notices cannot be construed as modifying the License.

You may add Your own copyright statement to Your modifications and may provide additional or different license terms and conditions for use, reproduction, or distribution of Your modifications, or for any such Derivative Works as a whole, provided Your use, reproduction, and distribution of the Work otherwise complies with the conditions stated in this License.

5. Submission of Contributions. Unless You explicitly state otherwise, any Contribution intentionally submitted for inclusion in the Work by You to the Licensor shall be under the terms and conditions of this License, without any additional terms or conditions. Notwithstanding the above, nothing herein shall supersede or modify the terms of any separate license agreement you may have executed with Licensor regarding such Contributions.
6. Trademarks. This License does not grant permission to use the trade names, trademarks, service marks, or product names of the Licensor, except as required for reasonable and customary use in describing the origin of the Work and reproducing the content of the NOTICE file.
7. Disclaimer of Warranty. Unless required by applicable law or agreed to in writing, Licensor provides the Work (and each Contributor provides its Contributions) on an “AS IS” BASIS, WITHOUT WARRANTIES OR CONDITIONS OF ANY KIND, either express or implied, including, without limitation, any warranties or conditions of TITLE, NON-INFRINGEMENT, MERCHANTABILITY, or FITNESS FOR A PARTICULAR PURPOSE. You are solely responsible for determining the appropriateness of using or redistributing the Work and assume any risks associated with Your exercise of permissions under this License.
8. Limitation of Liability. In no event and under no legal theory, whether in tort (including negligence), contract, or otherwise, unless required by applicable law (such as deliberate and grossly negligent acts) or agreed to in writing, shall any Contributor be liable to You for damages, including any direct, indirect, special, incidental, or consequential damages of any character arising as a result of this License or out of the use or inability to use the Work (including but not limited to damages for loss of goodwill, work stoppage, computer failure or malfunction, or any and all other commercial damages or losses), even if such Contributor has been advised of the possibility of such damages.
9. Accepting Warranty or Additional Liability. While redistributing the Work or Derivative Works thereof, You may choose to offer, and charge a fee for, acceptance of support, warranty, indemnity, or other liability obligations and/or rights consistent with this License. However, in accepting such obligations, You may act only on Your own behalf and on Your sole responsibility, not on behalf of any other Contributor, and only if You agree to indemnify, defend, and hold each Contributor harmless for any liability incurred by, or claims asserted against, such Contributor by reason of your accepting any such warranty or additional liability.

END OF TERMS AND CONDITIONS

©2022 Bose Corporation

Licensed under the Apache License, Version 2.0 (the “License”); you may not use this file except in compliance with the License.

You may obtain a copy of the License at: <http://www.apache.org/licenses/LICENSE-2.0>

Unless required by applicable law or agreed to in writing, software distributed under the License is distributed on an “AS IS” BASIS, WITHOUT WARRANTIES OR CONDITIONS OF ANY KIND, either express or implied.

See the License for the specific language governing permissions and limitations under the License.

CONTENU DE L'EMBALLAGE

Composants livrés	13
-------------------------	----

APPLICATION BOSE MUSIC

Téléchargement de l'application Bose Music.....	14
Ajout du casque à un compte existant	14

COMMANDES DU CASQUE

Mise sous tension.....	16
Minuterie de mise en veille.....	16
Mise hors tension	17
Fonctions du casque	18
Lecture multimédia et volume.....	18
Appels téléphoniques	19
Touche Action	20

RÉDUCTION DES BRUITS AMBIANTS

Modes de réduction des bruits ambiants.....	21
Modification du mode de réduction des bruits ambiants.....	21

COMMANDES VOCALES

Accès aux commandes vocales	22
-----------------------------------	----

CONNEXIONS *BLUETOOTH*[®]

Connexion via le menu <i>Bluetooth</i> de votre périphérique mobile.....	23
Déconnexion d'un périphérique mobile.....	25
Reconnexion d'un périphérique mobile	25
Connexion d'un autre périphérique mobile.....	25
Identification des périphériques mobiles connectés	25
Commutation entre deux périphériques mobiles connectés	25
Reconnexion d'un périphérique précédemment connecté.....	26
Suppression de la liste des périphériques du casque	26

CONNEXIONS CÂBLÉES

Raccordement du câble audio.....	27
----------------------------------	----

BATTERIE

Chargement du casque	28
Temps de charge.....	28
Annonce du niveau de la batterie	28

ÉTAT DU CASQUE

État <i>Bluetooth</i>	29
État de la batterie	29
État de charge	30
État de la mise à jour et des erreurs	30

CONNEXION DES PRODUITS BOSE

Connexion d'une enceinte Bose Smart Speaker ou d'une barre de son Bose Smart Soundbar	31
Avantages.....	31
Produits compatibles	31
Connexion à l'aide de l'application Bose Music	31
Reconnexion d'une enceinte Bose Smart Speaker ou d'une barre de son Bose Smart Soundbar.....	32

ENTRETIEN

Rangement du casque.....	33
Nettoyage du casque.....	34
Pièces de rechange et accessoires	34
Garantie limitée.....	34
Emplacement du numéro de série.....	35

RÉSOLUTION DES PROBLÈMES

Solutions de base..... 36

Autres solutions..... 36

Restauration des paramètres d'usine du casque 39

COMPOSANTS LIVRÉS

Vérifiez la présence des composants suivants :



Casque Bose QuietComfort 45

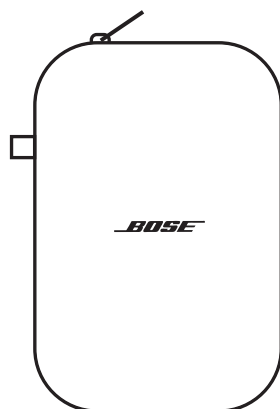

Étui de transport souple



Câble USB Type-C®

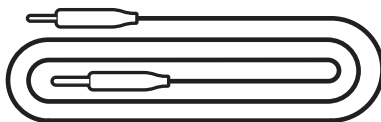

Câble audio 3,5 mm à 2,5 mm

REMARQUE : si l'un de ces éléments est endommagé, ne l'utilisez pas. Contactez immédiatement votre revendeur Bose agréé ou le service client de Bose.

Rendez-vous sur support.bose.com/QCSE

L'application Bose Music permet de configurer et de contrôler le casque à partir de votre périphérique mobile, notamment votre smartphone ou tablette.

Grâce à cette application, vous pouvez gérer les connexions *Bluetooth*, gérer les paramètres du casque, sélectionner la langue du guide vocal et accéder à de nouvelles fonctions par le biais de mises à jour.

REMARQUE : si vous avez déjà créé un compte Bose Music pour un autre produit Bose, ajoutez le casque à votre compte existant (consultez le bas de la page 14).

TÉLÉCHARGEMENT DE L'APPLICATION BOSE MUSIC

1. Téléchargez l'application Bose Music sur votre périphérique mobile.

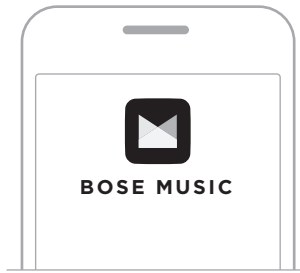

2. Suivez les instructions de l'application.

AJOUT DU CASQUE À UN COMPTE EXISTANT

Pour ajouter votre casque Bose QuietComfort 45, ouvrez l'application Bose Music et ajoutez-le.

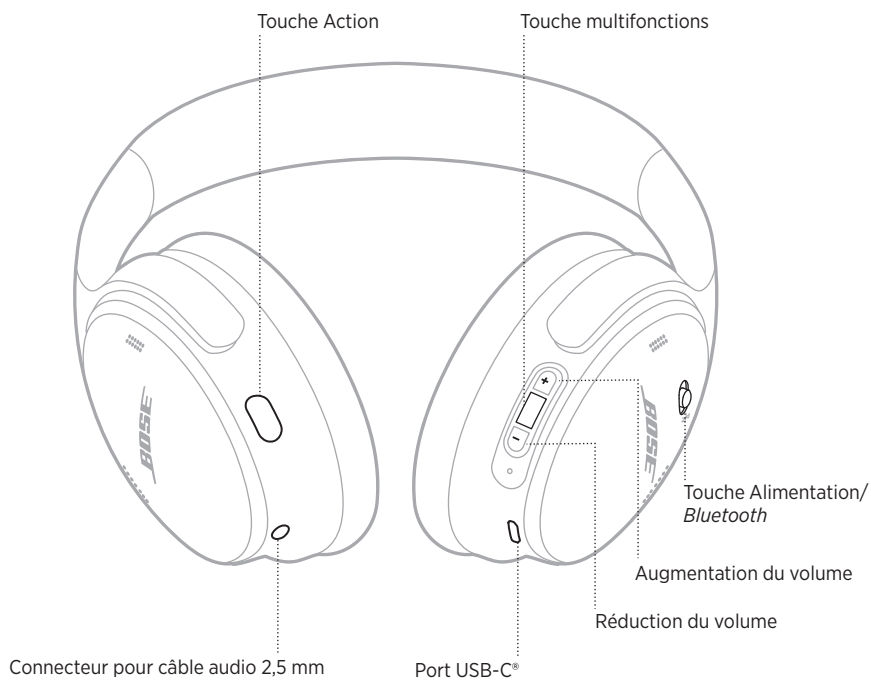

MISE SOUS TENSION

Sur l'écouteur droit, déplacez la touche Alimentation/*Bluetooth* vers la droite.

Un message vocal annonce le niveau de la batterie et le voyant d'état s'allume en fonction du niveau de charge actuel (consultez la page 29).



Minuterie de mise en veille

La minuterie de mise en veille permet d'économiser la batterie lorsque vous n'utilisez pas le casque.

Pour configurer et personnaliser la minuterie de mise en veille, utilisez l'application Bose Music.

MISE HORS TENSION

Déplacez la touche Alimentation/*Bluetooth* vers la gauche.



REMARQUE : lorsque le casque est hors tension, la fonction de réduction des bruits ambiants est désactivée.

FONCTIONS DU CASQUE

Les commandes du casque se trouvent derrière l'écouteur droit.

Lecture multimédia et volume

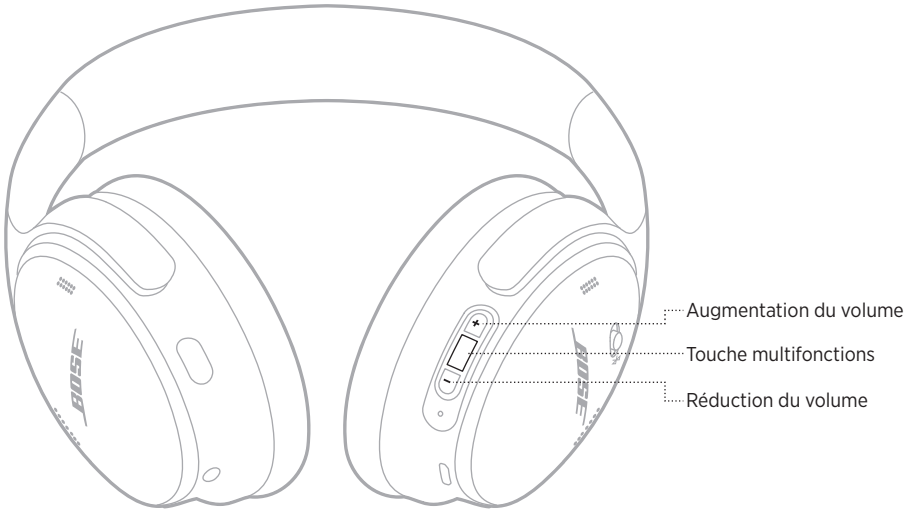

Augmentation du volume
Touche multifonctions
Réduction du volume

FONCTION	PROCÉDURE À SUIVRE
Lecture/Pause	Appuyez sur la touche multifonctions.
Saut avant	Appuyez deux fois sur la touche multifonctions.
Saut arrière	Appuyez trois fois sur la touche multifonctions.
Augmentation du volume	Appuyez sur la touche +.
Réduction du volume	Appuyez sur la touche —.

REMARQUES :

- Pour augmenter rapidement le volume, maintenez la touche + enfoncée.
- Pour réduire rapidement le volume, maintenez la touche — enfoncée.

Appels téléphoniques

La touche multifonctions se trouve derrière l'écouteur droit. Le microphone se trouve à proximité de la partie avant de l'écouteur droit.

La touche Action se trouve derrière l'écouteur gauche.

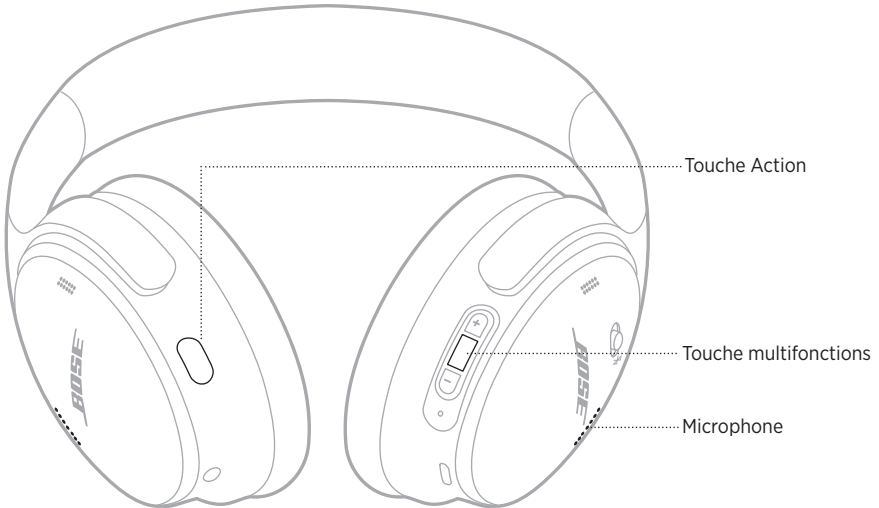

FONCTION	PROCÉDURE À SUIVRE
Répondre/mettre fin à un appel	Appuyez sur la touche multifonctions.
Refuser un appel	Appuyez sur la touche multifonctions pendant 1 seconde.
Répondre à un deuxième appel entrant et mettre le premier appel en attente	Si vous êtes en communication et recevez un deuxième appel, appuyez sur la touche multifonctions.
Refuser un deuxième appel entrant et conserver l'appel en cours	Si vous êtes en communication et recevez un deuxième appel, appuyez sur la touche multifonctions pendant 1 seconde.
Passer d'un appel à l'autre	Lorsque deux appels sont en cours, appuyez deux fois sur la touche multifonctions.
Créer une conférence	Lorsque deux appels sont en cours, appuyez sur la touche multifonctions pendant 3 secondes.
Couper/restaurer le son lors d'un appel	Pendant une communication, appuyez deux fois sur la touche Action.

Touche Action

La touche Action permet de changer rapidement et facilement de mode de réduction des bruits ambiants.

La touche Action se trouve derrière l'écouteur gauche.

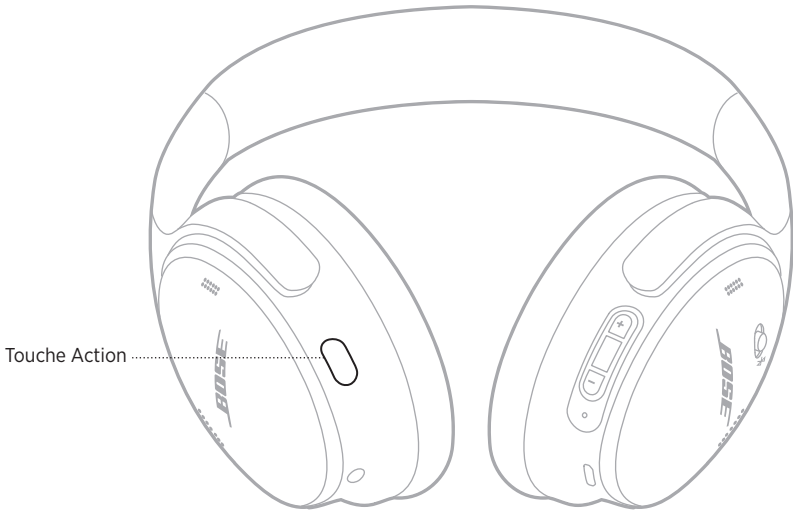

Pour commuter les modes Silence et Attentif, appuyez sur la touche Action.

Pour en savoir plus sur les modes de réduction des bruits ambiants, reportez-vous à la page 21.

La fonction de réduction des bruits ambiants permet de réduire les bruits indésirables pour vous offrir une reproduction réaliste du son. Vous avez le choix entre deux modes de réduction des bruits ambiants : le mode Silence et le mode Attentif.

Le mode Silence vous permet de vous isoler de toute distraction en utilisant le niveau de réduction des bruits ambiants le plus élevé.

Le mode Attentif vous offre une transparence totale en vous permettant d'entendre tous les bruits environnants.

Choisissez le mode de réduction des bruits ambiants en fonction de vos préférences d'écoute et de votre environnement.

MODES DE RÉDUCTION DES BRUITS AMBIANTS

MODE	DESCRIPTION
Silence	Réduction des bruits ambiants optimale grâce au son Bose optimisé.
Attentif	Vous entendez les bruits environnants tout en profitant de votre musique.

REMARQUE : une fois le casque sous tension, le dernier mode que vous avez sélectionné est automatiquement activé.

MODIFICATION DU MODE DE RÉDUCTION DES BRUITS AMBIANTS

Pour modifier le mode de réduction des bruits ambiants, appuyez sur la touche Action.

Une invite vocale annonce le mode de réduction des bruits ambiants sélectionné.

CONSEIL : vous pouvez également modifier le mode de réduction des bruits ambiants à l'aide de l'application Bose Music.

ACCÈS AUX COMMANDES VOCALES

Vous pouvez utiliser le casque de façon à accéder aux commandes vocales de votre périphérique mobile. Pour accéder aux commandes vocales, appuyez sur la touche multifonctions pendant 1 seconde.

La touche multifonctions se trouve derrière l'écouteur droit.

REMARQUE : vous ne pouvez pas accéder aux commandes vocales lorsque vous êtes en communication.

CONNEXION VIA LE MENU *BLUETOOTH* DE VOTRE PÉRIPHÉRIQUE MOBILE

Vous pouvez mémoriser jusqu'à huit périphériques dans la liste des périphériques du casque, et connecter activement jusqu'à deux périphériques simultanément. Vous ne pouvez pas écouter de la musique sur plusieurs périphériques mobiles en même temps.

REMARQUE : pour une meilleure expérience, utilisez l'application Bose Music pour configurer et connecter votre périphérique mobile (consultez la page 14).

1. Déplacez la touche Alimentation/*Bluetooth* \rightarrow vers la droite et maintenez-la dans cette position pendant 3 secondes.

Vous entendez l'indication « Prêt pour la connexion » et le voyant d'état clignote en bleu.



2. Activez la fonction *Bluetooth* sur votre périphérique.

REMARQUE : la fonction *Bluetooth* se trouve généralement dans le menu Réglages.

3. Sélectionnez votre casque dans la liste des périphériques.

CONSEIL : recherchez le nom que vous avez indiqué pour le casque dans l'application Bose Music. Si vous n'avez pas donné un nom à votre casque, le nom par défaut apparaît.



Une fois la connexion terminée, vous entendez le message « Connecté à <nom du périphérique> », et le voyant d'état reste allumé en bleu pendant 10 secondes.

DÉCONNEXION D'UN PÉRIPHÉRIQUE MOBILE

Utilisez l'application Bose Music pour déconnecter votre périphérique mobile.

CONSEIL : vous pouvez également utiliser les réglages *Bluetooth* pour déconnecter votre périphérique. La désactivation de la fonction *Bluetooth* déconnecte tous les autres périphériques.

RECONNEXION D'UN PÉRIPHÉRIQUE MOBILE

Lorsqu'il est sous tension, le casque tente de se reconnecter automatiquement aux deux périphériques les plus récemment connectés.

REMARQUES :

- Le périphérique doit se trouver dans le champ de portée (9 m) et être activé.
- Assurez-vous que la fonction *Bluetooth* est activée sur votre périphérique mobile.

CONNEXION D'UN AUTRE PÉRIPHÉRIQUE MOBILE

Pour connecter un périphérique supplémentaire, téléchargez l'application Bose Music (reportez-vous à la page 14) ou utilisez le menu *Bluetooth* de votre périphérique mobile (reportez-vous à la page 23).

REMARQUE : il est toutefois impossible d'écouter de la musique sur plusieurs périphériques en même temps.

IDENTIFICATION DES PÉRIPHÉRIQUES MOBILES CONNECTÉS

Déplacez la touche Alimentation/*Bluetooth* ✕ vers la droite et relâchez-la pour entendre le périphérique actuellement connecté.

COMMUTATION ENTRE DEUX PÉRIPHÉRIQUES MOBILES CONNECTÉS

1. Arrêtez la lecture sur votre premier périphérique mobile.
2. Démarrez la lecture sur votre deuxième périphérique mobile.

REMARQUE : votre casque peut recevoir des appels téléphoniques des deux périphériques, quel que soit celui sur lequel la lecture est en cours.

RECONNEXION D'UN PÉRIPHÉRIQUE PRÉCÉDEMMENT CONNECTÉ

1. Déplacez la touche Alimentation/*Bluetooth* ⌘ vers la droite et relâchez-la pour entendre le périphérique connecté.
2. Attendez 2 secondes, puis déplacez la touche Alimentation/*Bluetooth* ⌘ vers la droite et relâchez-la à nouveau pour vous connecter au périphérique suivant dans la liste des périphériques du casque.
3. Répétez cette procédure jusqu'à ce que vous entendiez le nom du périphérique correct.

Vous entendez une tonalité qui indique que l'appareil est connecté.

4. Démarrez la lecture sur le périphérique mobile connecté.

REMARQUE : si deux périphériques sont déjà connectés au casque, le périphérique nouvellement connecté remplace le périphérique préalablement connecté.

SUPPRESSION DE LA LISTE DES PÉRIPHÉRIQUES DU CASQUE

1. Déplacez le bouton Alimentation/*Bluetooth* ⌘ vers la droite et maintenez-le dans cette position pendant 15 secondes jusqu'à ce que vous entendiez l'indication « Liste des périphériques *Bluetooth* effacée. Prêt pour la connexion. »
 2. Supprimez les écouteurs de la liste *Bluetooth* de votre périphérique mobile.
- Tous les périphériques sont effacés de la liste et le casque est prêt pour la connexion.

RACCORDEMENT DU CÂBLE AUDIO

Utilisez le câble de 2,5 mm à 3,5 mm pour raccorder un périphérique câblé ou pour continuer d'utiliser le casque lorsque la batterie est épuisée.

1. Branchez le câble au connecteur 2,5 mm de l'écouteur gauche.



2. Insérez l'autre extrémité du câble dans le connecteur 3,5 mm de votre périphérique.

REMARQUE : lorsque vous connectez le câble audio, vous pouvez utiliser le casque, qu'il soit allumé ou éteint.

CHARGEMENT DU CASQUE

1. Raccordez le petit connecteur du câble USB à la prise USB-C de l'écouteur droit du casque.
2. Raccordez l'autre extrémité à un chargeur mural USB.



REMARQUES :

- Lorsque le casque commence à se charger, le voyant d'état clignote en blanc pendant 10 secondes. Lorsque le casque est complètement chargé, le voyant d'état cesse de clignoter et s'allume en blanc.
- Le casque ne fonctionne pas pendant la charge.

Temps de charge

Une charge complète du casque prend environ deux heures et trente minutes.

Annnonce du niveau de la batterie

Chaque fois que vous mettez le casque sous tension, un message vocal annonce le niveau de la batterie. Si la batterie est faible, vous entendez le message « Batterie faible, chargez le casque ».

REMARQUE : pour vérifier le niveau de la batterie, consultez le voyant d'état situé sur l'écouteur droit. Pour plus d'informations, reportez-vous à la section « État de la batterie » à la page 29.

Le voyant d'état se trouve sur l'écouteur droit.



ÉTAT *BLUETOOTH*

Indique l'état de la connexion *Bluetooth*.

ACTIVITÉ DU VOYANT	ÉTAT DU SYSTÈME
Clignote en bleu	Prêt pour la connexion
Allumé en bleu (10 secondes)	Connecté

ÉTAT DE LA BATTERIE

Ce voyant indique le niveau de la batterie.

ACTIVITÉ DU VOYANT	ÉTAT DU SYSTÈME
Reste allumé en blanc	Charge moyenne ou complète
Reste allumé en orange	Charge faible

CONSEIL : vous pouvez également consulter le niveau de la batterie à l'aide de l'application Bose Music.

ÉTAT DE CHARGE

Indique l'état de charge.

ACTIVITÉ DU VOYANT	ÉTAT DU SYSTÈME
Clignote en blanc à 2 reprises	La charge commence
Reste allumé en orange	Charge en cours
Reste allumé en blanc	Charge complète

ÉTAT DE LA MISE À JOUR ET DES ERREURS

Indique l'état de la mise à jour ou des erreurs.

ACTIVITÉ DU VOYANT	ÉTAT DU SYSTÈME
Clignote rapidement en blanc (10 secondes)	Mise à jour logicielle (via USB)
Clignote lentement en blanc (30 à 60 secondes)	Mise à jour logicielle (sans fil)
Clignote en orange et en blanc	Erreur. Contactez le service client de Bose.

CONNEXION D'UNE ENCEINTE BOSE SMART SPEAKER OU D'UNE BARRE DE SON BOSE SMART SOUNDBAR

La technologie Bose SimpleSync™ vous permet de connecter certains casques à une barre de son Bose Smart Soundbar ou à une enceinte Bose Smart Speaker pour une expérience d'écoute personnalisée.

Avantages

- Utilisez les commandes de réglage du volume indépendantes sur chaque produit pour baisser ou couper le son de votre barre de son Bose Smart Soundbar tout en maintenant votre casque au volume souhaité.
- Écoutez clairement votre musique dans la pièce d'à côté en connectant le casque à votre enceinte Bose Smart Speaker.

REMARQUE : la technologie SimpleSync™ offre une portée sans fil *Bluetooth* allant jusqu'à 9 mètres. Certains murs et matériaux de construction peuvent avoir une incidence sur la réception.

Produits compatibles

Vous pouvez connecter le casque à une enceinte Bose Smart Speaker ou à une barre de son Bose Smart Soundbar.

Les produits compatibles les plus connus sont les suivants :

- Bose Smart Soundbar 700/Bose Soundbar 700
- Bose Soundbar 500
- Bose Smart Speaker 500/Bose Home Speaker 500
- Enceinte Bose Home Speaker 300
- Bose Portable Smart Speaker/Bose Portable Home Speaker

De nouvelles fonctionnalités sont ajoutées périodiquement. Pour obtenir une liste complète, consultez la page worldwide.Bose.com/Support/Groups

Connexion à l'aide de l'application Bose Music

1. Sur le casque, déplacez la touche Alimentation/*Bluetooth* ⌘ vers la droite et maintenez-la dans cette position pendant 3 secondes.

Vous entendez le message « Prêt pour le jumelage d'un autre périphérique » et le voyant d'état clignote en bleu.

2. Utilisez l'application Bose Music pour connecter le casque à un produit Bose compatible. Pour de plus amples informations, rendez-vous sur worldwide.Bose.com/Support/Groups

REMARQUES :

- Vérifiez que le casque se trouve à portée (9 m) de la barre de son ou de l'enceinte.
- Vous pouvez vous connecter le casque à un seul produit à la fois.

RECONNEXION D'UNE ENCEINTE BOSE SMART SPEAKER OU D'UNE BARRE DE SON BOSE SMART SOUNDBAR

Mettez le casque sous tension (consultez la « Mise sous tension » à la page 16).

Le casque tente de se connecter automatiquement à l'appareil *Bluetooth* le plus récemment connecté, notamment à votre barre de son ou enceinte.

REMARQUES :

- La barre de son ou l'enceinte doit se trouver à moins de 9 m et être sous tension.
- Si le casque ne se reconnecte pas, consultez la section « Impossible de reconnecter le casque à une barre de son Bose Smart Soundbar ou à une enceinte Bose Smart Speaker connectée précédemment » à la page 38.

RANGEMENT DU CASQUE

Les écouteurs pivotent pour permettre un rangement à la fois simple et pratique. Placez le casque dans l'étui.

1. Faites pivoter les deux écouteurs vers l'intérieur pour les mettre à plat.

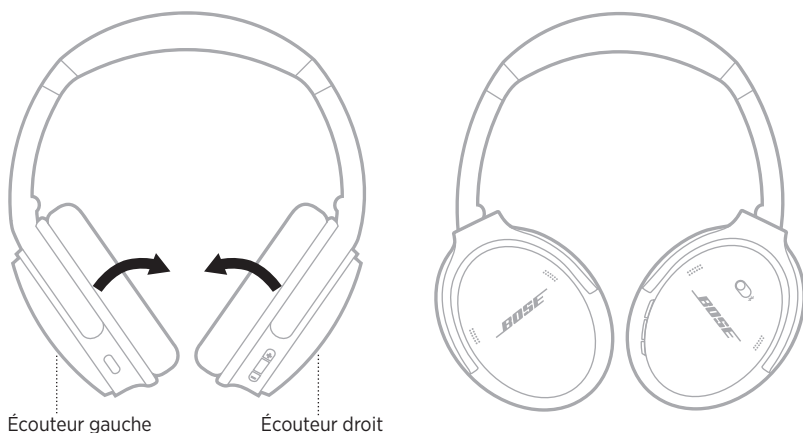

2. Pliez l'écouteur gauche vers le serre-tête.

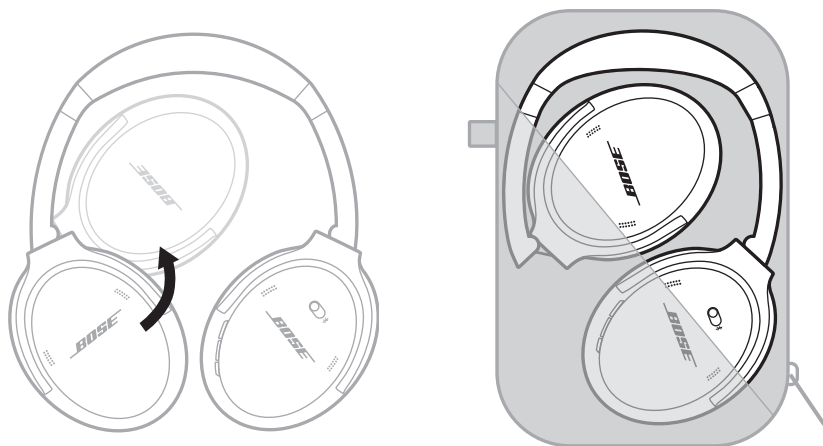

REMARQUES :

- Veillez à éteindre le casque lorsque vous ne l'utilisez pas.
- Avant de ranger le casque pour plusieurs mois, vérifiez que la batterie est complètement chargée.

NETTOYAGE DU CASQUE

Essayez les surfaces extérieures avec un chiffon doux et sec.

Veillez à protéger l'intérieur du casque contre l'humidité.

PIÈCES DE RECHANGE ET ACCESSOIRES

Vous pouvez commander des accessoires ou des pièces de rechange en vous adressant au service client de Bose. Consultez le site [support.Bose.com/QCSE](https://support.bose.com/QCSE)

GARANTIE LIMITÉE

Votre casque est couvert par une garantie limitée. Consultez notre site Web à l'adresse [worldwide.Bose.com/Warranty](https://worldwide.bose.com/Warranty) pour en savoir plus sur la garantie limitée.

Pour enregistrer votre produit, accédez à la page [worldwide.Bose.com/ProductRegistration](https://worldwide.bose.com/ProductRegistration). En cas d'oubli, les droits que vous confère cette garantie limitée ne s'en trouveront pas affectés.

EMPLACEMENT DU NUMÉRO DE SÉRIE

Le numéro de série se trouve à l'intérieur de l'écouteur droit, sous le canevas.
Le canevas est l'écran interne qui recouvre et protège les composants à l'intérieur de l'écouteur.

Pour connaître le numéro de série, saisissez la grille par le bord supérieur et retirez-la délicatement.

ATTENTION : veillez à n'exercer aucune pression et à ne retirer aucun autre composant à l'intérieur de l'écouteur, car vous risquez d'endommager le casque.

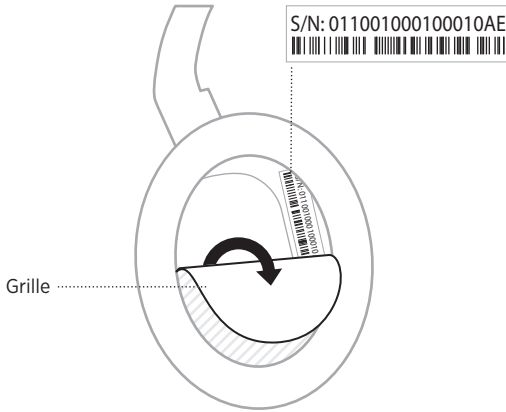

SOLUTIONS DE BASE

En cas de problèmes avec votre casque :

- Vérifiez les voyants d'état (reportez-vous à la page 29).
- Chargez la batterie (consultez la page 28).
- Augmentez le volume du casque, de votre périphérique mobile et de la source musicale.
- Téléchargez l'application Bose Music, puis exécutez les mises à jour logicielles disponibles (consultez la page 14).
- Essayez de connecter un autre périphérique mobile (reportez-vous à la page 25).

Si vous ne parvenez pas à résoudre votre problème, consultez le tableau ci-dessous pour identifier les symptômes et trouver des solutions aux problèmes courants. Si vous ne parvenez toujours pas à résoudre le problème, contactez le service client de Bose.

Rendez-vous sur worldwide.Bose.com/contact

AUTRES SOLUTIONS

SYMPTÔME	SOLUTION
Le casque ne se met pas sous tension	Chargez la batterie.
Impossible de connecter le casque au périphérique mobile	<p>Déconnectez le câble audio de secours.</p> <p>Déconnectez le câble de charge USB.</p> <p>Sur votre périphérique mobile :</p> <p>Désactivez la fonction <i>Bluetooth</i> et réactivez-la.</p> <p>Supprimez le casque Bose QuietComfort 45 de la liste <i>Bluetooth</i> de votre appareil, y compris toute liste dupliquée portant l'étiquette LE (Low Energy). Renouvelez la connexion.</p> <p>Rapprochez le périphérique mobile du casque et éloignez-le des sources d'interférences ou des obstructions.</p> <p>Consultez les didacticiels disponibles sur la page support.Bose.com/QCSE.</p> <p>Effacez la liste des périphériques connectés (reportez-vous à la page 26) et recommencez la procédure de connexion.</p>
La batterie ne se charge pas	<p>Vérifiez que le câble de charge USB est correctement connecté aux deux extrémités.</p> <p>Essayez d'utiliser une autre source de charge.</p> <p>Si votre casque a été exposé à des températures extrêmes, laissez-le revenir à température ambiante et essayez de le recharger.</p>

SYMPTÔME	SOLUTION
Absence de son	<p>Mettez le casque sous tension et chargez la batterie.</p> <p>Vérifiez les voyants d'état (reportez-vous à la page 29).</p> <p>Déplacez la touche Alimentation/<i>Bluetooth</i> vers la droite, puis relâchez-la pour entendre le périphérique connecté. Vérifiez que vous utilisez le périphérique correct.</p> <p>Rapprochez le périphérique mobile du casque et éloignez-le des sources d'interférences ou des obstructions.</p> <p>Utilisez une autre source musicale.</p> <p>Si deux périphériques mobiles sont connectés, veuillez tout d'abord à interrompre la lecture sur votre premier périphérique.</p> <p>Si deux périphériques mobiles sont connectés, placez-les dans le champ de portée du casque (9 m).</p> <p>Essayez d'utiliser un fichier audio ou vidéo enregistré localement sur votre périphérique mobile.</p>
Son de qualité médiocre	<p>Utilisez une autre source musicale.</p> <p>Connectez un autre périphérique mobile (reportez-vous à la page 25).</p> <p>Déconnectez le deuxième périphérique.</p> <p>Rapprochez le périphérique mobile du casque et éloignez-le des sources d'interférences ou des obstructions.</p> <p>Essayez d'utiliser un fichier audio ou vidéo enregistré localement sur votre périphérique mobile.</p>
Absence de son provenant d'un périphérique connecté à l'aide du câble audio de secours	<p>Vérifiez que le câble audio de secours est correctement connecté aux deux extrémités.</p> <p>Augmentez le volume sur votre casque, votre périphérique mobile et la source musicale.</p> <p>Connectez un autre périphérique (reportez-vous à la page 25).</p>
Absence de son provenant d'un périphérique connecté via le câble audio	<p>Vérifiez que le câble audio de secours est correctement connecté aux deux extrémités.</p> <p>Connectez un autre périphérique (reportez-vous à la page 25).</p>
La touche Action ne permet pas de modifier le mode de réduction des bruits ambiants	<p>Vérifiez que votre casque est sous tension.</p> <p>Utilisez l'application Bose Music pour modifier le mode de réduction des bruits ambiants.</p>

SYMPTÔME	SOLUTION
<p>Impossible de connecter le casque à une barre de son Bose Smart Soundbar ou à une enceinte Bose Smart Speaker</p>	<p>Faites glisser la touche Alimentation/<i>Bluetooth</i> tout en maintenant l'appui jusqu'à ce que vous entendiez l'indication « Prêt pour la connexion d'un autre périphérique » et que voyant <i>Bluetooth</i> clignote en bleu.</p> <p>Vérifiez que le casque se trouve à portée (9 m) de la barre de son ou de l'enceinte.</p>
<p>Impossible de reconnecter le casque à une barre de son Bose Smart Soundbar ou à une enceinte Bose Smart Speaker connectée précédemment</p>	<p>Reconnectez un périphérique précédemment connecté (consultez la page 26).</p>
<p>Son différé lorsque le casque est connecté à une barre de son Bose Smart Soundbar ou à une enceinte Bose Smart Speaker</p>	<p>Téléchargez l'application Bose Music et exécutez les mises à jour logicielles disponibles.</p>

Une restauration des paramètres d'usine permet d'effacer tous les paramètres afin que le casque retrouve son état d'origine. Il est ensuite possible de configurer le casque comme si vous l'utilisez pour la première fois.

La restauration des paramètres d'usine est recommandée uniquement si vous rencontrez des difficultés avec le casque ou si le service client de Bose vous a demandé de le faire.

RESTAURATION DES PARAMÈTRES D'USINE DU CASQUE

1. Supprimez le casque de la liste *Bluetooth* de votre périphérique.
2. Supprimez le casque de votre compte Bose à l'aide de l'application Bose Music.

REMARQUE : pour en savoir plus sur la suppression du casque de votre compte Bose à l'aide de l'application Bose Music, consultez le site support.bose.com/QCSE

3. Déplacez la touche Alimentation/*Bluetooth* † vers la droite et maintenez-la dans cette position. En même temps, appuyez sur la touche Action pendant 30 secondes.

Le voyant d'état clignote en blanc. Au bout de 30 secondes, le voyant d'état clignote en orange pour indiquer que les paramètres d'usine sont en cours de restauration (2 à 3 secondes).

4. Une fois la restauration terminée, le voyant d'état clignote lentement en bleu. Les paramètres d'usine du casque sont maintenant rétablis.

Leggere e conservare tutte le istruzioni per la sicurezza, la tutela delle persone e l'uso del prodotto.

CE Bose Corporation dichiara che il presente prodotto è conforme ai requisiti essenziali e ad altre disposizioni applicabili della Direttiva 2014/53/UE e di tutte le altre direttive UE applicabili. La dichiarazione di conformità completa è disponibile all'indirizzo: www.Bose.com/compliance

UK CA Il presente prodotto è conforme a tutte le normative sulla compatibilità elettromagnetica del 2016 e a tutte le altre normative del Regno Unito applicabili. La dichiarazione di conformità completa è disponibile all'indirizzo: www.Bose.com/compliance

Bose Corporation dichiara che il presente prodotto è conforme ai requisiti essenziali delle normative sulle apparecchiature radio del 2017 e a tutte le altre normative del Regno Unito applicabili. La dichiarazione di conformità completa è disponibile all'indirizzo: www.Bose.com/compliance

Importanti istruzioni di sicurezza

Non utilizzare l'apparecchio in prossimità di acqua.

Utilizzare solo un panno asciutto per la pulizia.

Affidarsi a personale qualificato per tutti gli interventi di assistenza. Gli interventi di assistenza si rendono necessari quando l'apparato ha subito danni di qualsiasi tipo, ad esempio se il cavo di alimentazione o la spina sono danneggiati, se è stato versato del liquido o sono caduti oggetti sull'apparato, se l'apparato è stato esposto a pioggia o umidità, se non funziona normalmente o è caduto.

AVVISI/AVVERTENZE

- NON usare le cuffie a un volume elevato per un lungo periodo di tempo.
 - Per evitare danni all'udito, usare le cuffie a un livello di volume confortevole e moderato.
 - Abbassare il volume del dispositivo prima di indossare le cuffie nelle/sulle orecchie, quindi alzarlo gradualmente fino a raggiungere il livello d'ascolto più confortevole.
- NON usare le cuffie quando si guida per telefonare o per qualsiasi altro scopo.
- NON usare le cuffie con la funzione di riduzione del rumore attivata nei casi in cui l'impossibilità di sentire i rumori circostanti potrebbe presentare dei rischi per l'utente o per terzi (ad esempio se si sta andando in bicicletta o si cammina nel traffico o nei pressi di un cantiere o dei binari ferroviari). Rispettare le leggi previste per l'uso delle cuffie.
 - Spegnerle le cuffie, oppure disattivare la funzione di riduzione del rumore e regolare il volume in modo da poter sentire i rumori circostanti, compresi allarmi e segnali di avviso.
 - Tenere presente come i suoni sui quali si fa normalmente affidamento come promemoria o avvisi possono cambiare caratteristiche quando si usano le cuffie, anche nella modalità Suoni esterni udibili.
- NON usare le cuffie se emettono un suono inusuale di volume elevato. Se si presenta questo problema, spegnere le cuffie e contattare l'assistenza clienti Bose.
- Se si percepisce un aumento di temperatura o si riscontra una perdita di audio, rimuovere immediatamente le cuffie.
- NON utilizzare un adattatore per telefono cellulare per collegare le cuffie ai connettori presenti sui sedili degli aerei, per evitare il rischio di lesioni o di danni dovuti al surriscaldamento.
- NON usare le cuffie per comunicazioni aeronautiche.



Contiene parti di piccole dimensioni che possono rappresentare un pericolo di soffocamento. Non adatto per bambini di età inferiore ai 3 anni.



Questo prodotto contiene materiale magnetico. Rivolgersi al proprio medico per eventuali domande sui possibili effetti del prodotto sui dispositivi medici impiantati nel corpo umano.

- Per ridurre il rischio di incendi o scosse elettriche, NON esporre il prodotto a pioggia, gocce, schizzi o umidità, e non porre oggetti colmi di liquidi, ad esempio vasi, sopra o accanto al prodotto.
- Tenere il prodotto lontano dal fuoco e da fonti di calore. NON collocare sorgenti di fiamme libere (ad esempio candele accese) sul prodotto o nelle sue vicinanze.
- Utilizzare questo prodotto esclusivamente con un alimentatore LPS approvato da un ente per la sicurezza che rispetta i requisiti normativi locali (ad esempio, UL, CSA, VDE, CCC).
- NON apportare alterazioni non autorizzate al prodotto.
- Se la batteria dovesse perdere, evitare che il liquido entri in contatto con la pelle o gli occhi. In caso di contatto, richiedere assistenza medica.
- Non esporre prodotti contenenti batterie a un calore eccessivo (ad esempio luce diretta del sole, fuoco o simili).
- NON indossare le cuffie mentre sono in carica.

NOTA: questa apparecchiatura è stata sottoposta a collaudo ed è risultata conforme ai limiti relativi ai dispositivi digitali di Classe B previsti dalla Parte 15 delle norme FCC. Tali limiti sono stati fissati allo scopo di assicurare un'adeguata protezione dalle interferenze dannose nell'ambito di un'installazione residenziale. Questa apparecchiatura genera, utilizza e può irradiare energia a radiofrequenza e, se non viene installata e utilizzata in conformità alle istruzioni fornite, può interferire negativamente con le comunicazioni radiofoniche. Non esiste tuttavia alcuna garanzia che in una particolare installazione non si verificherà alcuna interferenza. Se questo dispositivo dovesse provocare interferenze con la ricezione radiotelevisiva (determinabili spegnendo e riaccendendo l'apparecchio), si dovrà provare a eliminare tali interferenze effettuando una o più delle seguenti operazioni:

- Riorientare o riposizionare il prodotto o l'antenna ricevente.
- Aumentare la distanza tra il dispositivo che provoca interferenza e il ricevitore.
- Collegare l'apparecchiatura a una presa appartenente a un circuito diverso rispetto a quella a cui è collegato il ricevitore.
- Rivolgersi al distributore o a un tecnico radiotelevisivo specializzato per ottenere assistenza.

Eventuali modifiche o alterazioni non espressamente approvate da Bose Corporation possono rendere nulla l'autorizzazione dell'utente all'utilizzo dell'apparecchiatura stessa.

Questo dispositivo è conforme alla parte 15 delle Norme FCC e agli standard ISED (Innovation, Science and Economic Development) Canada RSS esenti da licenza. Il funzionamento è soggetto alle due seguenti condizioni: (1) il dispositivo non può causare interferenze dannose e (2) deve accettare le interferenze ricevute, incluse quelle che potrebbero causare un funzionamento indesiderato del dispositivo.

Questo apparecchio rispetta i limiti previsti dalle norme FCC e ISED Canada per la popolazione in generale in merito alle radiazioni in radiofrequenza. Il trasmettitore non deve essere collocato oppure utilizzato in prossimità di altri radiotrasmettitori o antenne.

Conforme ai requisiti IMDA.

FCC ID: A94437310

IC: 3232A-437310

CAN ICES-3(B)/NMB-3(B)

Per l'Europa:

Banda di frequenza di funzionamento: 2400-2483,5 MHz.

Potenza in uscita massima inferiore a 20 dBm EIRP.

Poiché la potenza di trasmissione massima è inferiore ai limiti previsti dalle normative, i test SAR non sono necessari in base ai regolamenti applicabili.



Questo simbolo indica che il prodotto non deve essere smaltito con i rifiuti domestici, ma deve essere consegnato a una struttura di raccolta appropriata per il riciclaggio. Uno smaltimento e un riciclaggio corretti aiutano a preservare le risorse naturali, la salute e l'ambiente. Per ulteriori informazioni sullo smaltimento e sul riciclaggio di questo prodotto, rivolgersi alle autorità locali, al servizio di smaltimento dei rifiuti o al negozio presso il quale è stato acquistato.

Regolamenti tecnici per i dispositivi a radiofrequenza a bassa potenza

Senza autorizzazione concessa dalla NCC, non si autorizza nessuna società, impresa o utente a cambiare frequenza, incrementare la potenza di trasmissione o alterare le caratteristiche originali nonché le prestazioni di un dispositivo a radiofrequenza a bassa potenza. I dispositivi a radiofrequenza a bassa potenza non devono interferire in alcun modo con la sicurezza aerea o le comunicazioni legali; qualora si riscontrasse una situazione di questo genere, l'utente dovrà interrompere immediatamente l'utilizzo fino a quando non sarà stata eliminata qualsiasi interferenza. Per "comunicazioni legali" si intendono le comunicazioni radio operate in conformità con il Telecommunications Management Act (Legge sulla gestione delle telecomunicazioni degli Stati Uniti). I dispositivi a radiofrequenza a bassa potenza devono essere suscettibili di interferenze provenienti da comunicazioni legali o dispositivi irradianti onde radio ISM.

NON tentare di rimuovere la batteria ricaricabile agli ioni di litio da questo prodotto. Per la rimozione, contattare il rivenditore Bose di zona o un professionista qualificato.

La rimozione della batteria ricaricabile agli ioni di litio di questo prodotto deve essere eseguita esclusivamente da un professionista qualificato. Per ulteriori informazioni, contattare il rivenditore Bose locale o visitare products.bose.com/static/compliance/index.html.



Le batterie usate devono essere smaltite correttamente, attenendosi alle normative locali. Non bruciarle.



Nome e contenuto delle sostanze o degli elementi tossici o pericolosi						
Nome parte	Sostanze ed elementi tossici o pericolosi					
	Piombo (Pb)	Mercurio (Hg)	Cadmio (Cd)	Cromo esavalente (CR(VI))	Bifenile polibromurato (PBB)	Difenilitere polibromurato (PBDE)
Circuiti stampati	X	0	0	0	0	0
Parti di metallo	X	0	0	0	0	0
Parti di plastica	0	0	0	0	0	0
Diffusore	X	0	0	0	0	0
Cavi	X	0	0	0	0	0
Questa tabella è stata preparata in conformità alle disposizioni SJ/T 11364. 0: indica che la quantità della sostanza tossica o pericolosa contenuta in tutti i materiali omogenei della parte è inferiore al limite previsto dallo standard GB/T 26572. X: indica che la quantità della sostanza tossica o pericolosa contenuta in almeno uno dei materiali omogenei della parte è superiore al limite previsto dallo standard GB/T 26572.						

Data di produzione: l'ottava cifra del numero di serie corrisponde all'anno di produzione; ad esempio, "2" indica 2012 o 2022.

Importatore per la Cina: Bose Electronics (Shanghai) Company Limited, Level 6, Tower D, No. 2337 Gudai Rd. Minhang District, Shanghai 201100

Importatore per l'UE: Bose Products B.V., Gorslaan 60, 1441 RG Purmerend, Paesi Bassi

Importatore per il Messico: Bose de México S. de R.L. de C.V., Avenida Prado Sur #150, Piso 2, Interior 222 y 223, Colonia Lomas de Chapultepec V Sección, Miguel Hidalgo, Ciudad de México, C.P. 11000
Numero di telefono: +5255 (5202) 3545

Importatore per Taiwan: Bose Limited Taiwan Branch (H.K.), 9F., No. 10, Sec. 3, Minsheng E. Road, Zhongshan Dist. Taipei City 10480, Taiwan Numero di telefono: +886-2-2514 7676

Importatore per il Regno Unito: Bose Limited, Bose House, Quayside Chatham Maritime, Chatham, Kent, ME4 4QZ, Regno Unito

Assorbimento in entrata: 5 V --- 0,5 A

Intervallo di temperatura di carica: da 0 °C a 45 °C

Intervallo di temperatura di scaricamento: da -20 °C a 60 °C

Modello 437310. Il codice ID CMIIT si trova all'interno del padiglione, sotto la membrana.

Compilare e conservare le seguenti informazioni

I numeri di serie e di modello sono riportati all'interno del padiglione, sotto la membrana.

Numero di serie: _____

Numero di modello: _____

È consigliabile conservare lo scontrino fiscale insieme al manuale di istruzioni. Prima di procedere, è consigliabile registrare il prodotto Bose. La registrazione può essere eseguita facilmente alla pagina worldwide.bose.com/ProductRegistration

Informazioni sulla sicurezza

Questo prodotto è in grado di ricevere automaticamente aggiornamenti di sicurezza da Bose quando è connesso all'app Bose Music. Per ricevere gli aggiornamenti di sicurezza tramite l'app per dispositivi mobili, è necessario completare il processo di configurazione del prodotto nell'app Bose Music. **Se non si esegue la procedura di configurazione, sarà necessario provvedere personalmente all'installazione degli aggiornamenti della sicurezza che Bose renderà disponibili su btu.bose.com**

Apple, il logo Apple, iPad, iPhone e iPod sono marchi di Apple, Inc. registrati negli USA e in altri paesi. App Store è un marchio di servizio di Apple Inc. Il marchio "iPhone" è utilizzato su licenza di Aiphone K.K.

L'uso del badge "Made for Apple" attesta che un accessorio è stato progettato per connettersi specificamente ai prodotti Apple indicati nel badge stesso, ed è stato certificato dallo sviluppatore come conforme agli standard di prestazioni Apple. Apple non è responsabile del funzionamento di questo dispositivo o della conformità dello stesso agli standard di sicurezza e normativi.

Il marchio in lettere e i loghi *Bluetooth*[®] sono marchi registrati di proprietà di Bluetooth SIG, Inc. e qualsiasi uso da parte di Bose Corporation è soggetto a licenza.

Google Play è un marchio commerciale di Google LLC.

USB Type-C[®] e USB-C[®] sono marchi registrati di USB Implementers Forum.

Bose, Bose Home Speaker, Bose Music, il logo Bose Music, Bose Smart Soundbar, Bose Smart Speaker, Bose Soundbar, QuietComfort e SimpleSync sono marchi commerciali di Bose Corporation.

Sede principale di Bose Corporation: 1-877-230-5639

©2022 Bose Corporation. Nessuna parte di questo documento può essere riprodotta, modificata, distribuita o usata in altro modo senza previa autorizzazione scritta.

The following license disclosures apply to certain third-party software packages used as components in the product.

Package: FreeRTOS

Copyright © Amazon Web Services, Inc. or its affiliates. All rights reserved.

The FreeRTOS package is subject to the license terms reprinted below:

MIT License

Permission is hereby granted, free of charge, to any person obtaining a copy of this software and associated documentation files (the “Software”), to deal in the Software without restriction, including without limitation the rights to use, copy, modify, merge, publish, distribute, sublicense, and/or sell copies of the Software, and to permit persons to whom the Software is furnished to do so, subject to the following conditions:

The above copyright notice and this permission notice shall be included in all copies or substantial portions of the Software.

THE SOFTWARE IS PROVIDED “AS IS”, WITHOUT WARRANTY OF ANY KIND, EXPRESS OR IMPLIED, INCLUDING BUT NOT LIMITED TO THE WARRANTIES OF MERCHANTABILITY, FITNESS FOR A PARTICULAR PURPOSE AND NONINFRINGEMENT. IN NO EVENT SHALL THE AUTHORS OR COPYRIGHT HOLDERS BE LIABLE FOR ANY CLAIM, DAMAGES OR OTHER LIABILITY, WHETHER IN AN ACTION OF CONTRACT, TORT OR OTHERWISE, ARISING FROM, OUT OF OR IN CONNECTION WITH THE SOFTWARE OR THE USE OR OTHER DEALINGS IN THE SOFTWARE.

Package: Nanopb

Copyright © 2011 Petteri Aimonen <jpa at nanopb.mail.kapsi.fi>.

The Nanopb package is subject to the license terms reprinted below:

Zlib License

© 2011 Petteri Aimonen <jpa at nanopb.mail.kapsi.fi>

This software is provided ‘as-is’, without any express or implied warranty. In no event will the authors be held liable for any damages arising from the use of this software.

Permission is granted to anyone to use this software for any purpose, including commercial applications, and to alter it and redistribute it freely, subject to the following restrictions:

1. The origin of this software must not be misrepresented; you must not claim that you wrote the original software. If you use this software in a product, an acknowledgment in the product documentation would be appreciated but is not required.
2. Altered source versions must be plainly marked as such, and must not be misrepresented as being the original software.
3. This notice may not be removed or altered from any source distribution.

Package: Mbed TLS 2.16.1

© ARM Limited. All rights reserved.

The Mbed TLS package is subject to the license terms reprinted below:

Apache License

Version 2.0, January 2004

<http://www.apache.org/licenses/>

TERMS AND CONDITIONS FOR USE, REPRODUCTION, AND DISTRIBUTION

1. Definitions.
“License” shall mean the terms and conditions for use, reproduction, and distribution as defined by Sections 1 through 9 of this document.

“Licensor” shall mean the copyright owner or entity authorized by the copyright owner that is granting the License.

“Legal Entity” shall mean the union of the acting entity and all other entities that control, are controlled by, or are under common control with that entity. For the purposes of this definition, “control” means (i) the power, direct or indirect, to cause the direction or management of such entity, whether by contract or otherwise, or (ii) ownership of fifty percent (50%) or more of the outstanding shares, or (iii) beneficial ownership of such entity.

“You” (or “Your”) shall mean an individual or Legal Entity exercising permissions granted by this License.

“Source” form shall mean the preferred form for making modifications, including but not limited to software source code, documentation source, and configuration files.

“Object” form shall mean any form resulting from mechanical transformation or translation of a Source form, including but not limited to compiled object code, generated documentation, and conversions to other media types.

“Work” shall mean the work of authorship, whether in Source or Object form, made available under the License, as indicated by a copyright notice that is included in or attached to the work (an example is provided in the Appendix below).

“Derivative Works” shall mean any work, whether in Source or Object form, that is based on (or derived from) the Work and for which the editorial revisions, annotations, elaborations, or other modifications represent, as a whole, an original work of authorship. For the purposes of this License, Derivative Works shall not include works that remain separable from, or merely link (or bind by name) to the interfaces of, the Work and Derivative Works thereof.

“Contribution” shall mean any work of authorship, including the original version of the Work and any modifications or additions to that Work or Derivative Works thereof, that is intentionally submitted to Licensor for inclusion in the Work by the copyright owner or by an individual or Legal Entity authorized to submit on behalf of the copyright owner. For the purposes of this definition, “submitted” means any form of electronic, verbal, or written communication sent to the Licensor or its representatives, including but not limited to communication on electronic mailing lists, source code control systems, and issue tracking systems that are managed by, or on behalf of, the Licensor for the purpose of discussing and improving the Work, but excluding communication that is conspicuously marked or otherwise designated in writing by the copyright owner as “Not a Contribution.”

“Contributor” shall mean Licensor and any individual or Legal Entity on behalf of whom a Contribution has been received by Licensor and subsequently incorporated within the Work.

2. Grant of Copyright License. Subject to the terms and conditions of this License, each Contributor hereby grants to You a perpetual, worldwide, non-exclusive, no-charge, royalty-free, irrevocable copyright license to reproduce, prepare Derivative Works of, publicly display, publicly perform, sublicense, and distribute the Work and such Derivative Works in Source or Object form.
3. Grant of Patent License. Subject to the terms and conditions of this License, each Contributor hereby grants to You a perpetual, worldwide, non-exclusive, no-charge, royalty-free, irrevocable (except as stated in this section) patent license to make, have made, use, offer to sell, sell, import, and otherwise transfer the Work, where such license applies only to those patent claims licensable by such Contributor that are necessarily infringed by their Contribution(s) alone or by combination of their Contribution(s) with the Work to which such Contribution(s) was submitted. If You institute patent litigation against any entity (including a cross-claim or counterclaim in a lawsuit) alleging that the Work or a Contribution incorporated within the Work constitutes direct or contributory patent infringement, then any patent licenses granted to You under this License for that Work shall terminate as of the date such litigation is filed.
4. Redistribution. You may reproduce and distribute copies of the Work or Derivative Works thereof in any medium, with or without modifications, and in Source or Object form, provided that You meet the following conditions:
 - a. You must give any other recipients of the Work or Derivative Works a copy of this License; and
 - b. You must cause any modified files to carry prominent notices stating that You changed the files; and
 - c. You must retain, in the Source form of any Derivative Works that You distribute, all copyright, patent, trademark, and attribution notices from the Source form of the Work, excluding those notices that do not pertain to any part of the Derivative Works; and

d. If the Work includes a “NOTICE” text file as part of its distribution, then any Derivative Works that You distribute must include a readable copy of the attribution notices contained within such NOTICE file, excluding those notices that do not pertain to any part of the Derivative Works, in at least one of the following places: within a NOTICE text file distributed as part of the Derivative Works; within the Source form or documentation, if provided along with the Derivative Works; or, within a display generated by the Derivative Works, if and wherever such third-party notices normally appear. The contents of the NOTICE file are for informational purposes only and do not modify the License. You may add Your own attribution notices within Derivative Works that You distribute, alongside or as an addendum to the NOTICE text from the Work, provided that such additional attribution notices cannot be construed as modifying the License.

You may add Your own copyright statement to Your modifications and may provide additional or different license terms and conditions for use, reproduction, or distribution of Your modifications, or for any such Derivative Works as a whole, provided Your use, reproduction, and distribution of the Work otherwise complies with the conditions stated in this License.

5. Submission of Contributions. Unless You explicitly state otherwise, any Contribution intentionally submitted for inclusion in the Work by You to the Licensor shall be under the terms and conditions of this License, without any additional terms or conditions. Notwithstanding the above, nothing herein shall supersede or modify the terms of any separate license agreement you may have executed with Licensor regarding such Contributions.
6. Trademarks. This License does not grant permission to use the trade names, trademarks, service marks, or product names of the Licensor, except as required for reasonable and customary use in describing the origin of the Work and reproducing the content of the NOTICE file.
7. Disclaimer of Warranty. Unless required by applicable law or agreed to in writing, Licensor provides the Work (and each Contributor provides its Contributions) on an “AS IS” BASIS, WITHOUT WARRANTIES OR CONDITIONS OF ANY KIND, either express or implied, including, without limitation, any warranties or conditions of TITLE, NON-INFRINGEMENT, MERCHANTABILITY, or FITNESS FOR A PARTICULAR PURPOSE. You are solely responsible for determining the appropriateness of using or redistributing the Work and assume any risks associated with Your exercise of permissions under this License.
8. Limitation of Liability. In no event and under no legal theory, whether in tort (including negligence), contract, or otherwise, unless required by applicable law (such as deliberate and grossly negligent acts) or agreed to in writing, shall any Contributor be liable to You for damages, including any direct, indirect, special, incidental, or consequential damages of any character arising as a result of this License or out of the use or inability to use the Work (including but not limited to damages for loss of goodwill, work stoppage, computer failure or malfunction, or any and all other commercial damages or losses), even if such Contributor has been advised of the possibility of such damages.
9. Accepting Warranty or Additional Liability. While redistributing the Work or Derivative Works thereof, You may choose to offer, and charge a fee for, acceptance of support, warranty, indemnity, or other liability obligations and/or rights consistent with this License. However, in accepting such obligations, You may act only on Your own behalf and on Your sole responsibility, not on behalf of any other Contributor, and only if You agree to indemnify, defend, and hold each Contributor harmless for any liability incurred by, or claims asserted against, such Contributor by reason of your accepting any such warranty or additional liability.

END OF TERMS AND CONDITIONS

©2022 Bose Corporation

Licensed under the Apache License, Version 2.0 (the “License”); you may not use this file except in compliance with the License.

You may obtain a copy of the License at: <http://www.apache.org/licenses/LICENSE-2.0>

Unless required by applicable law or agreed to in writing, software distributed under the License is distributed on an “AS IS” BASIS, WITHOUT WARRANTIES OR CONDITIONS OF ANY KIND, either express or implied.

See the License for the specific language governing permissions and limitations under the License.

NELLA CONFEZIONE

Contenuto	13
-----------------	----

APP BOSE MUSIC

Scaricare l'app Bose Music.....	14
Aggiungere le cuffie a un account esistente.....	14

CONTROLLI DELLE CUFFIE

Accensione	16
Timer di standby	16
Spegnimento	17
Funzioni delle cuffie.....	18
Riproduzione multimediale e controllo del volume	18
Chiamate.....	19
Pulsante Azione.....	20

RIDUZIONE DEL RUMORE

Modalità di riduzione del rumore	21
Cambiare la modalità di riduzione del rumore.....	21

CONTROLLO VOCALE

Accedere al controllo vocale.....	22
-----------------------------------	----

CONNESSIONI *BLUETOOTH*[®]

Connettere mediante il menu <i>Bluetooth</i> del dispositivo mobile.....	23
Disconnettere un dispositivo mobile.....	25
Riconnettere un dispositivo mobile.....	25
Connettere un altro dispositivo mobile.....	25
Identificare i dispositivi mobili connessi.....	25
Passare da un dispositivo mobile connesso a un altro	25
Riconnettere un dispositivo precedentemente connesso	26
Cancellare l'elenco dispositivi delle cuffie.....	26

CONNESSIONI CABLATE

Collegare il cavo audio	27
-------------------------------	----

BATTERIA

Caricare le cuffie	28
Tempo di carica	28
Ascoltare il livello della batteria.....	28

STATO DELLE CUFFIE

Stato <i>Bluetooth</i>	29
Stato batteria	29
Stato della carica	30
Aggiornamento e stato di errore	30

CONNETTERE PRODOTTI BOSE

Connettere una Bose Smart Soundbar o un Bose Smart Speaker.....	31
Vantaggi	31
Prodotti compatibili.....	31
Connettere mediante l'app Bose Music	31
Riconnettere un dispositivo Bose Smart Speaker o Soundbar.....	32

MANUTENZIONE

Conservare le cuffie	33
Pulire le cuffie.....	34
Parti di ricambio e accessori	34
Garanzia limitata	34
Posizione del numero di serie.....	35

RISOLUZIONE DEI PROBLEMI

Provare prima queste soluzioni	36
Altre soluzioni	36
Ripristinare le impostazioni di fabbrica delle cuffie.....	39

CONTENUTO

Verificare che i seguenti componenti siano inclusi:



Cuffie Bose QuietComfort 45

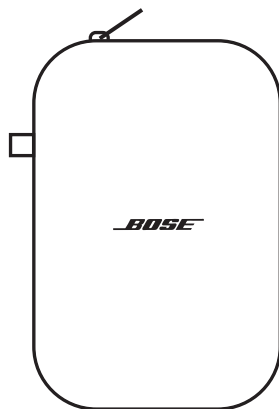

Custodia morbida per il trasporto



Cavo USB Type-C®

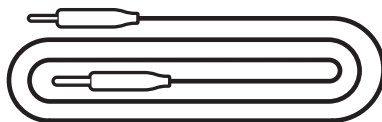

Cavo audio da 3,5 a 2,5 mm

NOTA: se il prodotto presenta parti danneggiate, non utilizzarlo. Contattare il rivenditore autorizzato Bose locale o il centro di assistenza tecnica Bose.

Visitare: support.Bose.com/QCSE

L'app Bose Music consente di impostare e controllare le cuffie da qualsiasi dispositivo mobile, ad esempio smartphone o tablet.

Utilizzando l'app è possibile gestire le connessioni *Bluetooth* e le impostazioni delle cuffie, scegliere la lingua delle istruzioni vocali e accedere alle nuove funzioni mediante gli aggiornamenti.

NOTA: se è stato già creato un account Bose Music per un altro prodotto Bose, aggiungere le cuffie a tale account (vedere in fondo a pagina 14).

SCARICARE L'APP BOSE MUSIC

1. Scaricare l'app Bose Music sul dispositivo mobile in uso.

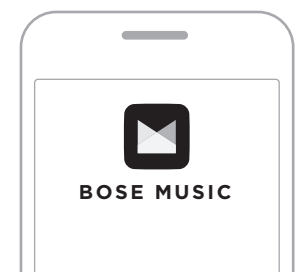

2. Seguire le istruzioni dell'app.

AGGIUNGERE LE CUFFIE A UN ACCOUNT ESISTENTE

Per aggiungere le cuffie Bose QuietComfort 45, aprire l'app Bose Music e aggiungerle.

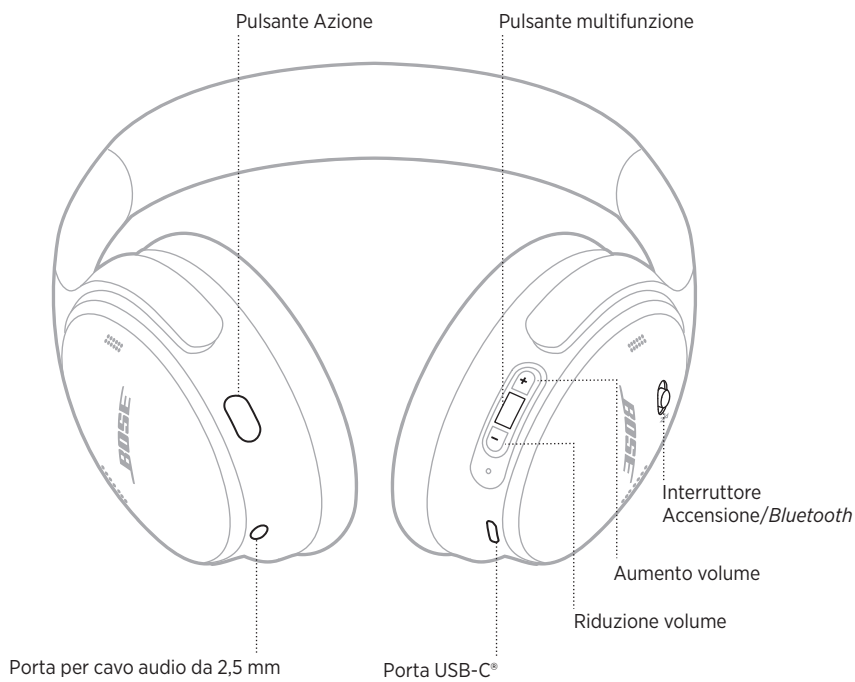

ACCENSIONE

Sul padiglione auricolare destro, fare scorrere l'interruttore di accensione/*Bluetooth* verso destra.

Un messaggio vocale segnala il livello della batteria e l'indicatore di stato si illumina in base al livello di carica corrente (vedere pagina 29).



Timer di standby

Il timer di standby conserva la carica della batteria quando le cuffie non sono in uso.

Utilizzare l'app Bose Music per impostare e personalizzare il timer di standby.

SPEGNIMENTO

Fare scorrere l'interruttore di accensione/*Bluetooth* verso sinistra.



NOTA: quando le cuffie sono spente, l'opzione di riduzione del rumore è disattivata.

FUNZIONI DELLE CUFFIE

I controlli delle cuffie si trovano sul retro del padiglione auricolare destro.

Riproduzione multimediale e controllo del volume

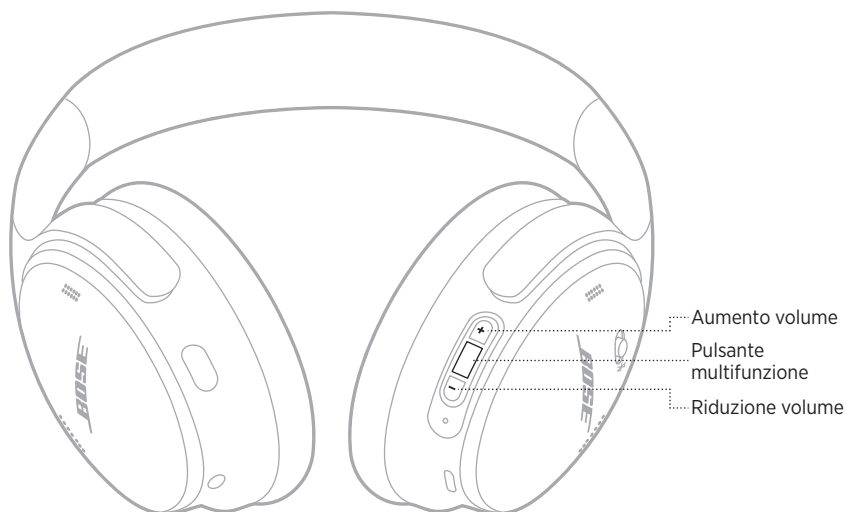

FUNZIONE	AZIONE
Riproduzione/pausa	Premere il pulsante multifunzione.
Salto in avanti	Premere due volte il pulsante multifunzione.
Salto all'indietro	Premere tre volte il pulsante multifunzione.
Aumento volume	Premere +.
Riduzione volume	Premere —.

NOTE:

- Per aumentare rapidamente il volume, premere e tenere premuto +.
- Per ridurre rapidamente il volume, premere e tenere premuto —.

Chiamate

Il pulsante multifunzione si trova sul retro del padiglione auricolare destro. Il microfono si trova presso la parte anteriore del padiglione auricolare destro.

Il pulsante Azione si trova sul retro del padiglione auricolare sinistro.

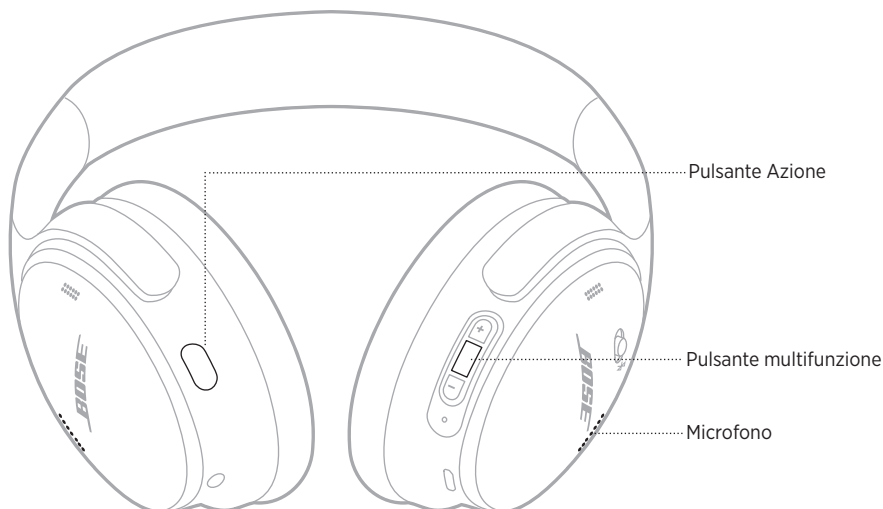

FUNZIONE	AZIONE
Rispondere/Chiudere una chiamata	Premere il pulsante multifunzione.
Rifiutare una chiamata in entrata	Tenere premuto il pulsante multifunzione per 1 secondo.
Rispondere a una seconda chiamata in entrata mettendo in attesa quella in corso	Se si riceve una seconda chiamata durante una chiamata in corso, premere il pulsante multifunzione.
Rifiutare una seconda chiamata in entrata rimanendo in quella in corso	Se si riceve una seconda chiamata durante una chiamata in corso, tenere premuto il pulsante multifunzione per 1 secondo.
Passare da una chiamata all'altra	Con due chiamate attive, premere due volte il pulsante multifunzione.
Creare una teleconferenza	Con due chiamate attive, tenere premuto il pulsante multifunzione per 3 secondi.
Azzerare/riattivare il volume di una chiamata	Durante una chiamata, premere due volte il pulsante Azione.

Pulsante Azione

Il pulsante Azione consente di passare facilmente e rapidamente tra le modalità di riduzione del rumore.

Il pulsante Azione si trova sul retro del padiglione auricolare sinistro.

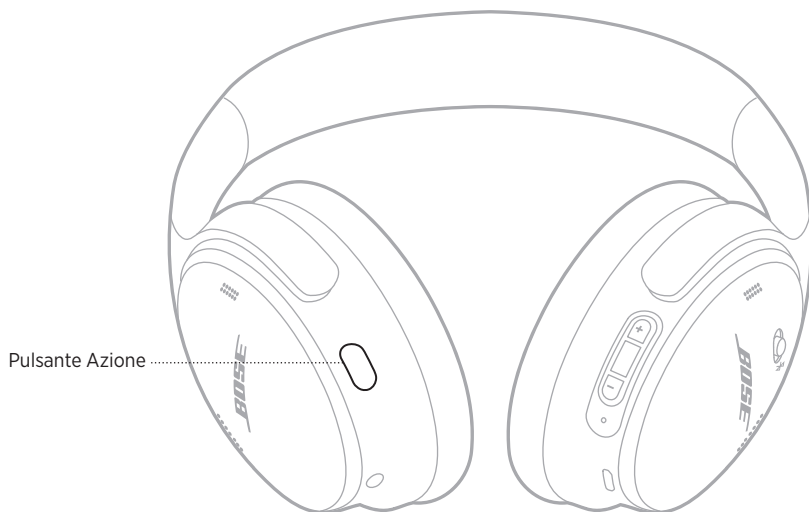

Per passare dalla modalità Silenzio alla modalità Suoni esterni udibili e viceversa, premere il pulsante Azione.

Per ulteriori informazioni sulle modalità di riduzione del rumore, vedere pagina 21.

La funzione di riduzione del rumore limita i rumori indesiderati per produrre un audio più nitido e realistico. È possibile scegliere tra due modalità di riduzione del rumore: Silenzio e Suoni esterni udibili.

La modalità Silenzio permette di eliminare qualsiasi rumore indesiderato, applicando il massimo livello di riduzione del rumore.

La modalità Suoni esterni udibili offre trasparenza totale e consente di sentire i rumori circostanti mentre l'audio è in riproduzione.

Scegliere la modalità di riduzione del rumore desiderata, in base alle proprie preferenze e all'ambiente di ascolto.

MODALITÀ DI RIDUZIONE DEL RUMORE

MODALITÀ	DESCRIZIONE
Silenzio	Eccezionale riduzione del rumore con l'audio ottimizzato Bose.
Suoni esterni udibili	Per avvertire i rumori circostanti mentre l'audio è in riproduzione.

NOTA: all'accensione, le cuffie impostano automaticamente l'ultima modalità utilizzata.

CAMBIARE LA MODALITÀ DI RIDUZIONE DEL RUMORE

Per cambiare la modalità di riduzione del rumore, premere il pulsante Azione.

Un messaggio vocale segnala la modalità di riduzione del rumore selezionata.

SUGGERIMENTO: è possibile cambiare la modalità di riduzione del rumore anche tramite l'app Bose Music.

ACCEDERE AL CONTROLLO VOCALE

È possibile utilizzare le cuffie per accedere al controllo vocale sul dispositivo mobile. Per accedere al controllo vocale, tenere premuto il pulsante multifunzione per 1 secondo.

Il pulsante multifunzione si trova sul retro del padiglione auricolare destro.

NOTA: non è possibile accedere al controllo vocale durante una chiamata.

CONNETTERE MEDIANTE IL MENU *BLUETOOTH* DEL DISPOSITIVO MOBILE

È possibile memorizzare fino a otto dispositivi nell'elenco dispositivi delle cuffie e connettere le cuffie attivamente a due dispositivi per volta. È possibile riprodurre l'audio da un solo dispositivo alla volta.

NOTA: per garantire un'esperienza ottimale, utilizzare l'app Bose Music per configurare e connettere il dispositivo mobile (vedere pagina 14).

1. Fare scorrere il pulsante di accensione/*Bluetooth* ➔ verso destra e mantenerlo in posizione per 3 secondi.

Si sentirà il messaggio "Pronto per la connessione" e l'indicatore di stato lampeggerà in blu.



2. Sul dispositivo, attivare la funzione *Bluetooth*.

NOTA: la funzione *Bluetooth* si trova in genere nel menu Impostazioni.

3. Selezionare le cuffie dall'elenco dei dispositivi.

SUGGERIMENTO: nell'app Bose Music, individuare il nome utilizzato per le cuffie. Se non è stato assegnato un nome alle cuffie, viene visualizzato il nome predefinito.



Una volta eseguita la connessione, si sentirà il messaggio vocale “Connesso a <nome dispositivo>” e l'indicatore di stato si illuminerà con luce blu fissa per 10 secondi.

DISCONNETTERE UN DISPOSITIVO MOBILE

Scollegare il dispositivo mobile tramite l'app Bose Music.

SUGGERIMENTO: si può scollegare il dispositivo anche dalle impostazioni *Bluetooth*. Se si disattiva la funzione *Bluetooth*, vengono scollegati anche tutti gli altri dispositivi.

RICONNETTERE UN DISPOSITIVO MOBILE

All'accensione, le cuffie tentano di riconnettersi agli ultimi due dispositivi connessi.

NOTE:

- Il dispositivo deve trovarsi nel raggio di portata del segnale (9 m) ed essere acceso.
- Verificare che sul dispositivo mobile sia stata attivata la funzione *Bluetooth*.

CONNETTERE UN ALTRO DISPOSITIVO MOBILE

Per connettere un altro dispositivo, scaricare l'app Bose Music (vedere pagina 14) o usare il menu *Bluetooth* del dispositivo mobile (vedere pagina 23).

NOTA: è possibile riprodurre l'audio da un solo dispositivo per volta.

IDENTIFICARE I DISPOSITIVI MOBILI CONNESSI

Fare scorrere l'interruttore di accensione/*Bluetooth* ✕ verso destra e rilasciarlo per riprodurre un'istruzione vocale che indica quale dispositivo è connesso.

PASSARE DA UN DISPOSITIVO MOBILE CONNESSO A UN ALTRO

1. Mettere in pausa l'audio sul primo dispositivo mobile.
2. Avviare la riproduzione dell'audio sul secondo dispositivo mobile.

NOTA: le cuffie possono ricevere una telefonata da entrambi i dispositivi, indipendentemente da quale dei due stia riproducendo l'audio.

RICONNETTERE UN DISPOSITIVO PRECEDENTEMENTE CONNESSO

1. Fare scorrere l'interruttore di accensione/*Bluetooth* ✂ verso destra e rilasciarlo per riprodurre un'istruzione vocale che indica quale dispositivo è connesso.
2. Entro due secondi, fare scorrere verso destra e rilasciare nuovamente l'interruttore di accensione/*Bluetooth* ✂ per connettersi al dispositivo successivo nell'elenco dispositivi delle cuffie.
3. Ripetere l'operazione fino a quando non si sente il nome del dispositivo desiderato.
Un segnale acustico indica che è in corso la connessione del dispositivo.
4. Avviare la riproduzione audio sul dispositivo mobile connesso.

NOTA: se alle cuffie sono già connessi due dispositivi, quello appena connesso si sostituisce al secondo dispositivo precedentemente connesso.

CANCELLARE L'ELENCO DISPOSITIVI DELLE CUFFIE

1. Fare scorrere il pulsante di accensione/*Bluetooth* ✂ verso destra e tenerlo premuto in questa posizione per 15 secondi, fino a quando non si sente l'istruzione "Elenco di dispositivi *Bluetooth* cancellato. Pronto per la connessione."
2. Rimuovere le cuffie dall'elenco *Bluetooth*[®] del dispositivo mobile.
Tutti i dispositivi vengono cancellati e le cuffie sono pronte per la connessione.

COLLEGARE IL CAVO AUDIO

Utilizzare il cavo da 2,5 mm a 3,5 mm per collegare un dispositivo non wireless o per continuare a usare le cuffie nel caso in cui la batteria sia scarica.

1. Collegare il cavo alla porta da 2,5 mm sul padiglione auricolare sinistro.



2. Collegare l'altra estremità del cavo alla porta da 3,5 mm del dispositivo.

NOTA: una volta collegato il cavo audio, si possono utilizzare le cuffie accese o spente.

CARICARE LE CUFFIE

1. Inserire l'estremità più piccola del cavo USB nella porta USB-C del padiglione auricolare destro.
2. Collegare l'altra estremità a un caricatore USB da parete.



NOTE:

- Quando le cuffie iniziano la fase di carica, l'indicatore di stato lampeggia in bianco per 10 secondi. Terminata la ricarica, l'indicatore di stato si illumina con luce bianca fissa.
- Durante la carica le cuffie non sono utilizzabili per la riproduzione.

Tempo di carica

Per caricare completamente le cuffie, sono necessarie fino a 2,5 ore.

Ascoltare il livello della batteria

Ogni volta che le cuffie vengono accese, un'istruzione vocale segnala il livello di carica della batteria. Se la batteria delle cuffie è scarica, si sente il messaggio "Batteria scarica, ricaricare".

NOTA: per verificare visivamente il livello di carica della batteria, osservare l'indicatore di stato posto sopra il padiglione auricolare destro. Per ulteriori informazioni, vedere "Stato batteria" a pagina 29.

L'indicatore di stato si trova sul padiglione auricolare destro.



STATO BLUETOOTH

Mostra lo stato della connessione *Bluetooth*.

ATTIVITÀ DELL'INDICATORE	STATO DEL SISTEMA
Blu lampeggiante	Pronto per la connessione
Blu fisso (10 secondi)	Connesso

STATO BATTERIA

Mostra il livello di carica della batteria.

ATTIVITÀ DELL'INDICATORE	STATO DEL SISTEMA
Bianco fisso	Batteria da mediamente a completamente carica
Arancione fisso	Batteria quasi scarica

SUGGERIMENTO: è possibile verificare il livello della batteria anche dall'app Bose Music.

STATO DELLA CARICA

Mostra lo stato di carica.

ATTIVITÀ DELL'INDICATORE	STATO DEL SISTEMA
Bianco lampeggiante per 2 volte	Inizio della carica
Arancione fisso	Carica in corso
Bianco fisso	Carica completa

AGGIORNAMENTO E STATO DI ERRORE

Mostra lo stato di aggiornamento o di errore.

ATTIVITÀ DELL'INDICATORE	STATO DEL SISTEMA
Bianco lampeggiante veloce (10 secondi)	Aggiornamento del software (tramite USB)
Bianco lampeggiante lento (da 30 a 60 secondi)	Aggiornamento del software (in modalità wireless)
Arancione e bianco lampeggianti	Errore - contattare l'assistenza clienti Bose

CONNETTERE UNA BOSE SMART SOUNDBAR O UN BOSE SMART SPEAKER

Con la tecnologia SimpleSync™ è possibile connettere le cuffie a una Bose Smart Soundbar oppure a un Bose Smart Speaker, per un'esperienza di ascolto personalizzata.

Vantaggi

- Si possono utilizzare i sistemi di controllo del volume indipendenti di ciascun prodotto per abbassare il volume o disattivare l'audio della Bose Smart Soundbar, mantenendo il volume delle cuffie al livello desiderato.
- Si può ascoltare nitidamente la musica proveniente dalla stanza accanto connettendo le cuffie al proprio Bose Smart Speaker.

NOTA: la tecnologia SimpleSync™ ha una portata *Bluetooth* massima di 9 metri. Le pareti e i materiali di costruzione possono talvolta influire negativamente sulla ricezione del segnale.

Prodotti compatibili

È possibile connettere le cuffie a qualsiasi Bose Smart Speaker o Bose Smart Soundbar.

I prodotti compatibili più diffusi sono:

- Bose Smart Soundbar 700/Bose Soundbar 700
- Bose Soundbar 500
- Bose Smart Speaker 500/Bose Home Speaker 500
- Bose Home Speaker 300
- Bose Portable Smart Speaker/Bose Portable Home Speaker

Nuovi prodotti vengono aggiunti periodicamente. Per un elenco completo e maggiori informazioni, visitare: worldwide.bose.com/Support/Groups

Connettere mediante l'app Bose Music

1. Sulle cuffie, fare scorrere il pulsante di accensione/*Bluetooth* ✕ verso destra e mantenerlo in posizione per 3 secondi.
Si sentirà il messaggio "Pronto per la connessione a un altro dispositivo" e l'indicatore di stato lampeggerà in blu.
2. Utilizzare l'app Bose Music per connettere le cuffie a un prodotto Bose compatibile. Per ulteriori informazioni, visitare: worldwide.bose.com/Support/Groups

NOTE:

- Assicurarsi che le cuffie siano entro un raggio di 9 metri dalla soundbar o dal diffusore.
- È possibile collegare le cuffie a un solo prodotto alla volta.

RICONNETTERE UN DISPOSITIVO BOSE SMART SPEAKER O SOUNDBAR

Accendere le cuffie (vedere “Accensione” a pagina 16).

Le cuffie provano a connettersi ai due dispositivi *Bluetooth* più recenti, inclusi la soundbar o il diffusore.

NOTE:

- La soundbar o il diffusore devono trovarsi nel raggio di portata del segnale (9 m) ed essere accesi.
- Se le cuffie non si riconnettono, vedere “Le cuffie non si riconnettono a una Bose Smart Soundbar o a un Bose Smart Speaker precedentemente connessi” a pagina 38.

CONSERVARE LE CUFFIE

I padiglioni si ripiegano all'interno per poter riporre le cuffie con la massima praticità. Riporre le cuffie distese nella custodia.

1. Ruotare entrambi i padiglioni verso l'interno finché non sono completamente piatti.



2. Piegare il padiglione sinistro in alto verso l'archetto.

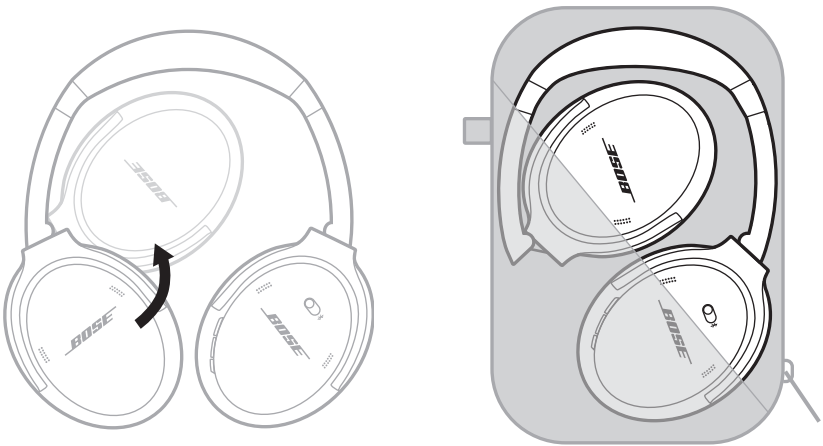

NOTE:

- Spegnere le cuffie quando non sono in uso.
- Prima di riporre le cuffie, se si prevede di non utilizzarle per vari mesi, assicurarsi che la batteria sia completamente carica.

PULIRE LE CUFFIE

Pulire la superficie esterna con un panno morbido e asciutto.

Evitare l'ingresso di umidità all'interno dei padiglioni.

PARTI DI RICAMBIO E ACCESSORI

Per ordinare parti di ricambio e accessori, rivolgersi al servizio clienti Bose.

Visitare: support.Bose.com/QCSE

GARANZIA LIMITATA

Le cuffie sono coperte da garanzia limitata. Per i dettagli della garanzia limitata, consultare il nostro sito web all'indirizzo worldwide.Bose.com/Warranty.

Per effettuare la registrazione del prodotto, seguire le istruzioni riportate alla pagina worldwide.Bose.com/ProductRegistration. La mancata registrazione non inciderà in alcun modo sui diritti previsti dalla garanzia limitata.

POSIZIONE DEL NUMERO DI SERIE

Il numero di serie si trova all'interno del padiglione auricolare destro, sotto la membrana. La membrana è la copertura interna che protegge i componenti all'interno del padiglione auricolare.

Per leggere il numero di serie, afferrare la membrana nell'angolo superiore e sollevarla delicatamente.

ATTENZIONE: prestare la massima attenzione a non toccare o rimuovere altri componenti all'interno del padiglione auricolare, poiché si potrebbero danneggiare le cuffie.

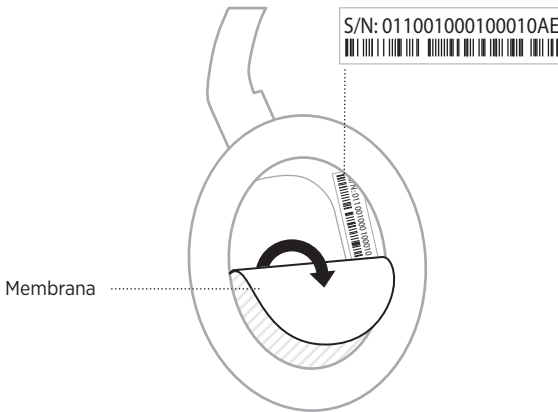

PROVARE PRIMA QUESTE SOLUZIONI

Se si dovessero riscontrare problemi con le cuffie:

- Controllare l'indicatore di stato (vedere pagina 29).
- Caricare la batteria (vedere pagina 28).
- Aumentare il volume delle cuffie, del dispositivo mobile e dell'app musicale.
- Scaricare l'app Bose Music ed eseguire gli aggiornamenti software disponibili (vedere pagina 14).
- Provare a connettere un altro dispositivo mobile (vedere pagina 25).

Se non si riesce a risolvere il problema, consultare la tabella seguente per individuare i sintomi e le possibili soluzioni dei problemi più comuni. Se non si è comunque in grado di risolvere il problema, contattare il servizio clienti Bose.

Visitare: worldwide.Bose.com/contact

ALTRE SOLUZIONI

SINTOMO	SOLUZIONE
Le cuffie non si accendono	Caricare la batteria.
Le cuffie non si connettono al dispositivo mobile	<p>Scollegare il cavo audio di backup.</p> <p>Scollegare il cavo di ricarica USB.</p> <p>Sul dispositivo mobile:</p> <p>Disattivare la funzione <i>Bluetooth</i> e riattivarla.</p> <p>Rimuovere le cuffie Bose QuietComfort 45 dall'elenco <i>Bluetooth</i> del dispositivo, comprese eventuali ripetizioni del nome con l'indicazione LE (Low Energy). Riconnettere.</p> <p>Avvicinare il dispositivo mobile alle cuffie e allontanare eventuali ostacoli o fonti di interferenza.</p> <p>Visitare support.Bose.com/QCSE per guardare i video dimostrativi.</p> <p>Cancellare l'elenco dispositivi collegati (vedere pagina 26) ed eseguire di nuovo la connessione.</p>
La batteria non si carica	<p>Verificare il corretto inserimento di entrambe le estremità del cavo di ricarica USB.</p> <p>Provare con un'altra sorgente di carica.</p> <p>Se le cuffie sono state esposte a temperature troppo basse o troppo alte, attendere che tornino a temperatura ambiente, quindi provare nuovamente a caricarle.</p>

SINTOMO	SOLUZIONE
Non si sente alcun suono	<p>Accendere le cuffie e caricare la batteria.</p> <p>Controllare l'indicatore di stato (vedere pagina 29).</p> <p>Fare scorrere l'interruttore di accensione/<i>Bluetooth</i> verso destra e rilasciarlo per riprodurre un'istruzione vocale che indica quale dispositivo è connesso. Assicurarsi che il dispositivo utilizzato sia quello corretto.</p> <p>Avvicinare il dispositivo mobile alle cuffie e allontanare eventuali ostacoli o fonti di interferenza.</p> <p>Provare a usare un'altra sorgente di riproduzione audio.</p> <p>Se sono connessi due dispositivi mobili, assicurarsi che uno dei due sia in pausa.</p> <p>Se sono connessi due dispositivi mobili, assicurarsi che entrambi si trovino entro il raggio di portata delle cuffie (9 m).</p> <p>Provare a riprodurre un brano musicale o un file video memorizzato localmente sul dispositivo mobile.</p>
Scarsa qualità del suono	<p>Provare a usare un'altra sorgente di riproduzione audio.</p> <p>Connettere un altro dispositivo mobile (vedere pagina 25).</p> <p>Scollare il secondo dispositivo.</p> <p>Avvicinare il dispositivo mobile alle cuffie e allontanare eventuali ostacoli o fonti di interferenza.</p> <p>Provare a riprodurre un brano musicale o un file video memorizzato localmente sul dispositivo mobile.</p>
Assenza di audio da un dispositivo collegato tramite il cavo audio di scorta	<p>Verificare il corretto inserimento di entrambe le estremità del cavo audio di backup.</p> <p>Aumentare il volume sulle cuffie, sul dispositivo mobile e sulla sorgente musicale.</p> <p>Connettere un altro dispositivo (vedere pagina 25).</p>
Qualità audio scadente da un dispositivo collegato mediante il cavo audio	<p>Verificare il corretto inserimento di entrambe le estremità del cavo audio di backup.</p> <p>Connettere un altro dispositivo (vedere pagina 25).</p>
Il pulsante Azione non cambia la modalità di riduzione del rumore	<p>Verificare che le cuffie siano accese.</p> <p>Utilizzare l'app Bose Music per cambiare la modalità di riduzione del rumore.</p>

SINTOMO	SOLUZIONE
Le cuffie non si connettono a una Bose Smart Soundbar o a un Bose Smart Speaker	<p>Fare scorrere e tenere premuto il pulsante di accensione/<i>Bluetooth</i> finché non si sente il messaggio "Pronto per la connessione a un altro dispositivo"; l'indicatore <i>Bluetooth</i> lampeggia in blu.</p> <p>Assicurarsi che le cuffie siano entro un raggio di 9 metri dalla soundbar o dal diffusore.</p>
Le cuffie non si riconnettono a una Bose Smart Soundbar o a un Bose Smart Speaker precedentemente connessi	<p>Ricollegarsi a un dispositivo precedentemente connesso (vedere pagina 26).</p>
Ritardo nell'audio quando si effettua la connessione a una Bose Smart Soundbar o a un Bose Smart Speaker	<p>Scaricare l'app Bose Music ed eseguire gli aggiornamenti software disponibili.</p>

Un ripristino alle impostazioni di fabbrica può cancellare tutte le impostazioni, riportando le cuffie allo stato originale, come fossero appena state rimosse dalla confezione. In seguito, è possibile configurare le cuffie come se questa procedura non fosse mai stata eseguita.

Il ripristino alle impostazioni di fabbrica va eseguito solo se si incontrano dei problemi con le cuffie, oppure se consigliato espressamente dall'assistenza clienti Bose.

RIPRISTINARE LE IMPOSTAZIONI DI FABBRICA DELLE CUFFIE

1. Rimuovere le cuffie dall'elenco *Bluetooth* del dispositivo.
2. Rimuovere le cuffie dall'account Bose mediante l'app Bose Music.

NOTA: per ulteriori informazioni sulla rimozione delle cuffie dall'account Bose mediante l'app Bose Music, visitare: support.bose.com/QCSE

3. Fare scorrere l'interruttore di accensione/*Bluetooth* verso ✕ destra e tenerlo premuto. Allo stesso tempo, tenere premuto il pulsante Azione per 30 secondi.

L'indicatore di stato lampeggia in bianco. Trascorsi 30 secondi, l'indicatore di stato lampeggia in arancione per segnalare che si stanno ripristinando le impostazioni di fabbrica (2-3 secondi).

4. Terminato il ripristino, l'indicatore di stato lampeggia lentamente in blu. Ora le cuffie sono tornate allo stato originale, come se non fossero mai state utilizzate.

Kérjük, olvassa el, és tartsa be a biztonsági és használati utasításokat.

CE A Bose Corporation ezennel kijelenti, hogy a jelen termék megfelel a rádióberendezésekre és távközlési végberendezésekre vonatkozó 2014/53/EK irányelv és minden más idevonatkozó EU-irányelv alapvető követelményeinek és egyéb rendelkezéseinek. A teljes megfelelőségi nyilatkozat a következő címen található: www.Bose.com/compliance.

**UK
CA** A jelen termék megfelel az elektromágneses kompatibilitásról szóló 2016-os szabályozás összes vonatkozó irányelvének és az összes vonatkozó egyesült királyságbeli törvény előírásának. A teljes megfelelőségi nyilatkozat a következő címen található: www.Bose.com/compliance.

A Bose Corporation ezennel kijelenti, hogy a jelen termék megfelel a rádióberendezésekre vonatkozó 2017. évi irányelv és minden más idevonatkozó egyesült királyságbeli irányelv alapvető követelményeinek. A teljes megfelelőségi nyilatkozat a következő címen található: www.Bose.com/compliance.

Fontos biztonsági utasítások

Ne használja a készüléket víz közelében.

Csak száraz ronggyal tisztítsa.

A javítási munkákat bízza szakemberre. Szervizelésre akkor van szükség, ha a készülék valamilyen módon meghibásodott, például megsérült a hálózati csatlakozószínörja vagy a csatlakozódugója, folyadék ömlött vagy nehéz tárgy esett rá, eső vagy nedvesség érte, működésében rendellenesség tapasztalható, vagy leesett.

VIGYÁZAT / FIGYELMEZTETÉS

- NE használja a fejhallgatót huzamosabb ideig magas hangerőn.
 - A halláskárosodás elkerülése érdekében a fejhallgatót a fül számára kellemes, mérsékelt hangerővel használja.
 - Halkítsa le az eszközt, mielőtt a fülére/fülébe helyezné, majd fokozatosan hangosítsa fel, amíg el nem éri az Ön számára megfelelő hangerőt.
- NE használja a fejhallgatót vezetés közben telefonálásra vagy más célra.
- NE használja a fejhallgatót a zajkioltó funkcióval akkor, amikor a környező hangok figyelmen kívül hagyása veszélyt jelent saját magára vagy másokra nézve, például kerékpározás közben, forgalmas utcán vagy járdán, építési területen, vasút közelében stb., és kövesse a fejhallgató használatára vonatkozó törvényi rendelkezéseket.
 - Kapcsolja ki a fejhallgatót, vagy a fejhallgatót kikapcsolt zajsűrítő funkcióval használja, és állítsa be a hangerőt úgy, hogy hallja a környező hangokat, ideértve a riasztási és a figyelmeztető hangjelzéseket is.
 - Tudatosítsa, hogy az emlékeztetési vagy figyelmeztetési célra szolgáló hangok a fejhallgató használat esetén szokatlanul hangozhatnak, még Éber módban is.
- NE használja a fejhallgatót, ha az hangos vagy szokatlan zajt bocsát ki. Ilyenkor kapcsolja ki a fejhallgatót, és forduljon a Bose vevőszolgálatához.
- Azonnal vegye le a fejhallgatót, ha melegedést vagy hangkimaradást tapasztal.
- NE csatlakoztassa a fejhallgatót mobiltelefon-adapter segítségével a repülőgépekbe épített aljzathoz, mert az sérülést vagy anyagi kárt okozhat a túlmelegedés miatt.
- NE használja a fejhallgatót légiforgalmi kommunikációs eszközként.



A termék apró részeket tartalmaz, melyek fulladást okozhatnak. 3 éves kor alatti gyermekek számára nem alkalmas.



A termék mágneses anyagot tartalmaz. Tájékoztadjon kezelőorvosánál, hogy ez hatással lehet-e az Ön által használt beültethető orvostechnikai eszközre.

- A tűz és az áramütés kockázatának csökkentése érdekében NE tegye ki a terméket esőnek, és ne hagyja, hogy a termékre víz csöpögjön vagy fröccsenjen, illetve hogy nedvesség érje, és ne helyezzen vázát vagy más, folyadékkal töltött edényt a termékre vagy annak közelébe.
- Tartsa a terméket távol tűztől és más hőforrásoktól. A termékre és annak közelébe TILOS gyertyát vagy egyéb nyílt lánggal működő eszközt helyezni.
- A terméket csak valamely ügynökség (például UL, CSA, VDE, CCC) által jóváhagyott, a helyi jogszabályi követelményeknek megfelelő LPS-tápegységgel használja.
- NE végezzen a terméken engedély nélküli módosítást.
- Az akkumulátor szivárgása esetén ügyeljen arra, hogy a folyadék ne hogy a bőrére vagy a szemébe kerüljön. A folyadékkal történő érintkezés esetén forduljon orvoshoz.
- Óvja az akkumulátort tartalmazó termékeket a túlzott hőhatástól, például a közvetlen napsütéstől, a tűztől és hasonló hatásoktól.
- NE viselje töltés közben.

MEGJEGYZÉS: A berendezést az FCC-szabályzat 15. cikke szerint tesztelték. Ez alapján a berendezés megfelel a „B” osztályú digitális eszközök előírásainak. Ezen határértékek megfelelő védelmet nyújtanak a káros sugárzások ellen lakóépületen belül. A berendezés rádiófrekvenciás energiát termel, használ és sugározhat, és amennyiben nem az utasításoknak megfelelően helyezik üzembe és használják, a rádiókommunikációra nézve káros interferenciát okozhat. Arra azonban nincs garancia, hogy adott körülmények között nem lép fel interferencia. Ha a berendezés nem kívánt interferenciával zavarja a rádió- vagy a televízióadást (ezt a berendezés ki- és bekapcsolásával lehet ellenőrizni), javasoljuk, hogy az interferencia kiküszöbölése érdekében próbálkozzon az alábbiak egyikével:

- Fordítsa el vagy helyezze át a terméket vagy az antennát.
- Növelje a berendezés és a vevőkészülék közötti távolságot.
- A berendezést a vevőkészülék áramellátását biztosító áramkörtől eltérő áramkör aljzatához csatlakoztassa.
- Forduljon a forgalmazóhoz vagy tapasztalt rádió-/televíziószerelőhöz.

A Bose Corporation által kifejezetten jóvá nem hagyott módosítások vagy változtatások esetén érvénytelenül válhat a berendezés működtetésére adott felhasználói engedély.

Ez a készülék megfelel az FCC-szabályzat 15. részének és az ISED Canada nem engedélyköteles RSS-szabványainak. A működés során a következő két feltételnek kell eleget tenni: (1) ez a készülék nem bocsáthat ki káros interferenciát, és (2) ennek a készüléknek el kell viselnie bármilyen interferenciát, az esetlegesen rendellenes működést okozó interferenciát is beleértve.

Ez a készülék megfelel az FCC és az ISED Canada által az általános népelességre vonatkozóan megállapított sugárzási határértékeknek. Ezt a jeladót tilos bármilyen antenna vagy jeladó mellé helyezni, illetve azokkal együtt használni.

Megfelel az IMDA követelményeinek.

FCC ID: A94437310

IC: 3232A-437310

CAN ICES-3(B)/NMB-3(B)

Európában:

Működési frekvenciatartomány: 2400–2483,5 MHz.

A maximális átviteli teljesítmény kevesebb mint 20 dBm EIRP.

A maximális átviteli teljesítmény a törvényben meghatározott korlátok alatt van, ezért az SAR-tesztelésre nincs szükség, és a vonatkozó előírások értelmében az alól kivételt képez.



Ez a szimbólum azt jelenti, hogy a terméket nem szabad a háztartási hulladékkal együtt kidobni, hanem egy megfelelő hulladékkezelő létesítményben kell leadni, ahol gondoskodnak a termék újrahasznosításáról.

A megfelelő hulladékkezelés és újrahasznosítás hozzájárul a természeti erőforrások, az emberi egészség és a környezet védelméhez. A feleslegessé vált termék kezelésével és újrahasznosításával kapcsolatos további információkért forduljon a helyi önkormányzat hulladékkezeléssel megbízott szolgáltatójához, vagy ahhoz az üzlethez, ahol ezt a terméket vásárolta.

A kisfogyasztású rádiófrekvenciás eszközök műszaki előírásai

A vállalatok, a szervezetek és a felhasználók az NCC külön engedélye nélkül nem változtathatják meg a jóváhagyott kisfogyasztású rádiófrekvenciás eszközök frekvenciáját, nem fokozhatják annak jeladási teljesítményét, és nem módosíthatják annak eredeti jellemzőit és teljesítményét. A kisfogyasztású rádiófrekvenciás eszközök nem befolyásolhatják a repülőgépek biztonságát, illetve nem okozhatnak interferenciát a jogszerűen engedélyezett kommunikációban. Ha ez mégis megtörténik, a felhasználónak azonnal abba kell hagynia a készülék használatát, amíg az interferencia meg nem szűnik. Az említett jogi kommunikáció a távközlési felügyeleti törvénynek („Telecommunications Management Act”) megfelelő rádiókommunikációra vonatkozik. A kisfogyasztású rádiófrekvenciás eszközöknek el kell viselniük a jogilag engedélyezett kommunikációból származó vagy a rádióhullámokat kibocsátó ISM-készülékekről érkező interferenciát.

NE próbálja meg eltávolítani az újratölthető lítiumion akkumulátort a termékből. Az eltávolításhoz kérje a Bose helyi kereskedőjének vagy egy képesített szakembernek a segítségét.

A termékben található újratölthető lítiumion akkumulátort csak képzett szakember távolíthatja el. További információkért lépjen kapcsolatba a Bose helyi viszonteladójával, vagy látogasson el a products.bose.com/static/compliance/index.html weboldalra.



A használt akkumulátort helyesen, a helyi előírásoknak megfelelően kezelje hulladékként.
Az akkumulátort tilos elégetni.



Mérgező vagy veszélyes anyagok és vegyi elemek nevei a termékben						
Alkatrész neve	Mérgező vagy veszélyes anyagok és elemek					
	Ólom (Pb)	Higany (Hg)	Kadmium (Cd)	Hat vegyértékű króm (CR(VI))	Polibrómozott bifenil (PBB)	Polibrómozott difeniléter (PBDE)
NYÁK-ok	X	0	0	0	0	0
Fémrészek	X	0	0	0	0	0
Műanyag részek	0	0	0	0	0	0
Hangszóró	X	0	0	0	0	0
Kábelek	X	0	0	0	0	0
Ez a táblázat az SJ/T 11364 előírásainak megfelelően készült. 0: Azt jelzi, hogy az adott mérgező vagy veszélyes anyag mennyisége az adott alkatrész egyetlen homogén anyagában sem éri el a GB/T 26572 által meghatározott határértéket. X: Azt jelzi, hogy az adott mérgező vagy veszélyes anyagot az alkatrész legalább egy homogén anyaga a GB/T 26572 korlátozó előírásait meghaladó mértékben tartalmazza.						

Gyártás dátuma: A gyári szám nyolcadik számjegye a gyártási évet jelzi: például a „2” 2012-t vagy 2022-t jelöl.

Kínai importőr: Bose Electronics (Shanghai) Company Limited, Level 6, Tower D, No. 2337 Gudai Rd. Minhang District, Shanghai 201100

EU-importőr: Bose Products B.V., Gorslaan 60, 1441 RG Purmerend, Hollandia

Mexikói importőr: Bose de México S. de R.L. de C.V., Avenida Prado Sur #150, Piso 2, Interior 222 y 223, Colonia Lomas de Chapultepec V Sección, Miguel Hidalgo, Ciudad de México, C.P. 11000 Telefonszám: +5255 (5202) 3545

Tajvani importőr: Bose Limited Taiwan Branch (H.K.), 9F., No. 10, Sec. 3, Minsheng E. Road, Zhongshan Dist. Taipei City 10480, Taiwan Phone Number: +886-2-2514 7676

Egyesült királyságbeli importőr: Bose Limited, Bose House, Quayside Chatham Maritime, Chatham, Kent, ME4 4QZ, United Kingdom

Névleges bemeneti értékek: 5 V --- 0,5 A

Töltési hőmérséklet-tartomány: 0 °C – 45 °C

Töltésleadási hőmérséklet-tartomány: -20 °C – 60 °C

Modellszám: 437310. A CMIIT-azonosító a fejhallgató belsejében, a bélés alatt található.

Feljegyzendő adatok

A gyári szám és a modellszám a fejhallgató belsejében, a bélés alatt található.

Gyári szám: _____

Modellszám: _____

A bizonylatot tartsa a kezelési útmutató mellett. Ragadja meg az alkalmat, és regisztrálja az Ön által vásárolt Bose terméket! Ezt egyszerűen megteheti a következő címen: worldwide.Bose.com/ProductRegistration

Biztonsági információk

A jelen termék alkalmas a Bose biztonsági frissítéseinek automatikus fogadására, amikor a Bose Music alkalmazáshoz kapcsolódik. Annak érdekében, hogy a mobilalkalmazáson keresztül fogadni tudj a biztonsági frissítéseket, a Bose Music alkalmazásban el kell végeznie a termékbeállítási folyamatot.

Ha nem végzi el a beállítási folyamatot, a Bose által a [btu.Bose.com](https://www.bose.com) webhelyen közzétett frissítések telepítéséért Ön felel.

Az Apple, az Apple embléma, az iPad, az iPhone és az iPod az Apple, Inc. Amerikai Egyesült Államokban és más országokban bejegyzett védjegye. Az App Store az Apple Inc. szolgáltatásjegye. Az „iPhone” védjegyet Japánban az Aiphone K.K. licencével használják.

A „Made for Apple” jelvény használata azt jelzi, hogy az adott tartozék kifejezetten a jelvényen feltüntetett Apple termék(ek)kel való használatra készült, és a fejlesztő az Apple működési követelményeinek teljesítésére vonatkozó tanúsítvánnyal látta el. Az Apple nem vállal felelősséget a jelen készülék működéséért, valamint annak biztonsági és megfelelőségi előírásoknak való megfeleléséért.

A *Bluetooth*[®] szövédjegy és emblémák a Bluetooth SIG, Inc. tulajdonát képező, bejegyzett védjegyek, amelyeket a Bose Corporation minden esetben engedéllyel használ.

A Google Play a Google LLC védjegye.

Az USB Type-C[®] és az USB-C[®] az USB Implementers Forum bejegyzett védjegye.

A Bose, a Bose Home Speaker, a Bose Music, a Bose Music embléma, a Bose Smart Soundbar, a Bose Smart Speaker, a Bose Soundbar, a QuietComfort és a SimpleSync a Bose Corporation védjegye.

Bose Corporation központja: 1-877-230-5639

© 2022 Bose Corporation. Előzetes írásos engedély nélkül a jelen kiadvány semmilyen része nem sokszorosítható, módosítható, terjeszthető, illetve nem használható fel semmilyen más módon.

The following license disclosures apply to certain third-party software packages used as components in the product.

Package: FreeRTOS

Copyright © Amazon Web Services, Inc. or its affiliates. All rights reserved.

The FreeRTOS package is subject to the license terms reprinted below:

MIT License

Permission is hereby granted, free of charge, to any person obtaining a copy of this software and associated documentation files (the “Software”), to deal in the Software without restriction, including without limitation the rights to use, copy, modify, merge, publish, distribute, sublicense, and/or sell copies of the Software, and to permit persons to whom the Software is furnished to do so, subject to the following conditions:

The above copyright notice and this permission notice shall be included in all copies or substantial portions of the Software.

THE SOFTWARE IS PROVIDED “AS IS”, WITHOUT WARRANTY OF ANY KIND, EXPRESS OR IMPLIED, INCLUDING BUT NOT LIMITED TO THE WARRANTIES OF MERCHANTABILITY, FITNESS FOR A PARTICULAR PURPOSE AND NONINFRINGEMENT. IN NO EVENT SHALL THE AUTHORS OR COPYRIGHT HOLDERS BE LIABLE FOR ANY CLAIM, DAMAGES OR OTHER LIABILITY, WHETHER IN AN ACTION OF CONTRACT, TORT OR OTHERWISE, ARISING FROM, OUT OF OR IN CONNECTION WITH THE SOFTWARE OR THE USE OR OTHER DEALINGS IN THE SOFTWARE.

Package: Nanopb

Copyright © 2011 Petteri Aimonen <jpa at nanopb.mail.kapsi.fi>.

The Nanopb package is subject to the license terms reprinted below:

Zlib License

© 2011 Petteri Aimonen <jpa at nanopb.mail.kapsi.fi>

This software is provided ‘as-is’, without any express or implied warranty. In no event will the authors be held liable for any damages arising from the use of this software.

Permission is granted to anyone to use this software for any purpose, including commercial applications, and to alter it and redistribute it freely, subject to the following restrictions:

1. The origin of this software must not be misrepresented; you must not claim that you wrote the original software. If you use this software in a product, an acknowledgment in the product documentation would be appreciated but is not required.
2. Altered source versions must be plainly marked as such, and must not be misrepresented as being the original software.
3. This notice may not be removed or altered from any source distribution.

Package: Mbed TLS 2.16.1

© ARM Limited. All rights reserved.

The Mbed TLS package is subject to the license terms reprinted below:

Apache License

Version 2.0, January 2004

<http://www.apache.org/licenses/>

TERMS AND CONDITIONS FOR USE, REPRODUCTION, AND DISTRIBUTION

1. Definitions.
“License” shall mean the terms and conditions for use, reproduction, and distribution as defined by Sections 1 through 9 of this document.

“Licensor” shall mean the copyright owner or entity authorized by the copyright owner that is granting the License.

“Legal Entity” shall mean the union of the acting entity and all other entities that control, are controlled by, or are under common control with that entity. For the purposes of this definition, “control” means (i) the power, direct or indirect, to cause the direction or management of such entity, whether by contract or otherwise, or (ii) ownership of fifty percent (50%) or more of the outstanding shares, or (iii) beneficial ownership of such entity.

“You” (or “Your”) shall mean an individual or Legal Entity exercising permissions granted by this License.

“Source” form shall mean the preferred form for making modifications, including but not limited to software source code, documentation source, and configuration files.

“Object” form shall mean any form resulting from mechanical transformation or translation of a Source form, including but not limited to compiled object code, generated documentation, and conversions to other media types.

“Work” shall mean the work of authorship, whether in Source or Object form, made available under the License, as indicated by a copyright notice that is included in or attached to the work (an example is provided in the Appendix below).

“Derivative Works” shall mean any work, whether in Source or Object form, that is based on (or derived from) the Work and for which the editorial revisions, annotations, elaborations, or other modifications represent, as a whole, an original work of authorship. For the purposes of this License, Derivative Works shall not include works that remain separable from, or merely link (or bind by name) to the interfaces of, the Work and Derivative Works thereof.

“Contribution” shall mean any work of authorship, including the original version of the Work and any modifications or additions to that Work or Derivative Works thereof, that is intentionally submitted to Licensor for inclusion in the Work by the copyright owner or by an individual or Legal Entity authorized to submit on behalf of the copyright owner. For the purposes of this definition, “submitted” means any form of electronic, verbal, or written communication sent to the Licensor or its representatives, including but not limited to communication on electronic mailing lists, source code control systems, and issue tracking systems that are managed by, or on behalf of, the Licensor for the purpose of discussing and improving the Work, but excluding communication that is conspicuously marked or otherwise designated in writing by the copyright owner as “Not a Contribution.”

“Contributor” shall mean Licensor and any individual or Legal Entity on behalf of whom a Contribution has been received by Licensor and subsequently incorporated within the Work.

2. Grant of Copyright License. Subject to the terms and conditions of this License, each Contributor hereby grants to You a perpetual, worldwide, non-exclusive, no-charge, royalty-free, irrevocable copyright license to reproduce, prepare Derivative Works of, publicly display, publicly perform, sublicense, and distribute the Work and such Derivative Works in Source or Object form.
3. Grant of Patent License. Subject to the terms and conditions of this License, each Contributor hereby grants to You a perpetual, worldwide, non-exclusive, no-charge, royalty-free, irrevocable (except as stated in this section) patent license to make, have made, use, offer to sell, sell, import, and otherwise transfer the Work, where such license applies only to those patent claims licensable by such Contributor that are necessarily infringed by their Contribution(s) alone or by combination of their Contribution(s) with the Work to which such Contribution(s) was submitted. If You institute patent litigation against any entity (including a cross-claim or counterclaim in a lawsuit) alleging that the Work or a Contribution incorporated within the Work constitutes direct or contributory patent infringement, then any patent licenses granted to You under this License for that Work shall terminate as of the date such litigation is filed.
4. Redistribution. You may reproduce and distribute copies of the Work or Derivative Works thereof in any medium, with or without modifications, and in Source or Object form, provided that You meet the following conditions:
 - a. You must give any other recipients of the Work or Derivative Works a copy of this License; and
 - b. You must cause any modified files to carry prominent notices stating that You changed the files; and
 - c. You must retain, in the Source form of any Derivative Works that You distribute, all copyright, patent, trademark, and attribution notices from the Source form of the Work, excluding those notices that do not pertain to any part of the Derivative Works; and

d. If the Work includes a “NOTICE” text file as part of its distribution, then any Derivative Works that You distribute must include a readable copy of the attribution notices contained within such NOTICE file, excluding those notices that do not pertain to any part of the Derivative Works, in at least one of the following places: within a NOTICE text file distributed as part of the Derivative Works; within the Source form or documentation, if provided along with the Derivative Works; or, within a display generated by the Derivative Works, if and wherever such third-party notices normally appear. The contents of the NOTICE file are for informational purposes only and do not modify the License. You may add Your own attribution notices within Derivative Works that You distribute, alongside or as an addendum to the NOTICE text from the Work, provided that such additional attribution notices cannot be construed as modifying the License.

You may add Your own copyright statement to Your modifications and may provide additional or different license terms and conditions for use, reproduction, or distribution of Your modifications, or for any such Derivative Works as a whole, provided Your use, reproduction, and distribution of the Work otherwise complies with the conditions stated in this License.

5. Submission of Contributions. Unless You explicitly state otherwise, any Contribution intentionally submitted for inclusion in the Work by You to the Licensor shall be under the terms and conditions of this License, without any additional terms or conditions. Notwithstanding the above, nothing herein shall supersede or modify the terms of any separate license agreement you may have executed with Licensor regarding such Contributions.
6. Trademarks. This License does not grant permission to use the trade names, trademarks, service marks, or product names of the Licensor, except as required for reasonable and customary use in describing the origin of the Work and reproducing the content of the NOTICE file.
7. Disclaimer of Warranty. Unless required by applicable law or agreed to in writing, Licensor provides the Work (and each Contributor provides its Contributions) on an “AS IS” BASIS, WITHOUT WARRANTIES OR CONDITIONS OF ANY KIND, either express or implied, including, without limitation, any warranties or conditions of TITLE, NON-INFRINGEMENT, MERCHANTABILITY, or FITNESS FOR A PARTICULAR PURPOSE. You are solely responsible for determining the appropriateness of using or redistributing the Work and assume any risks associated with Your exercise of permissions under this License.
8. Limitation of Liability. In no event and under no legal theory, whether in tort (including negligence), contract, or otherwise, unless required by applicable law (such as deliberate and grossly negligent acts) or agreed to in writing, shall any Contributor be liable to You for damages, including any direct, indirect, special, incidental, or consequential damages of any character arising as a result of this License or out of the use or inability to use the Work (including but not limited to damages for loss of goodwill, work stoppage, computer failure or malfunction, or any and all other commercial damages or losses), even if such Contributor has been advised of the possibility of such damages.
9. Accepting Warranty or Additional Liability. While redistributing the Work or Derivative Works thereof, You may choose to offer, and charge a fee for, acceptance of support, warranty, indemnity, or other liability obligations and/or rights consistent with this License. However, in accepting such obligations, You may act only on Your own behalf and on Your sole responsibility, not on behalf of any other Contributor, and only if You agree to indemnify, defend, and hold each Contributor harmless for any liability incurred by, or claims asserted against, such Contributor by reason of your accepting any such warranty or additional liability.

END OF TERMS AND CONDITIONS

©2022 Bose Corporation

Licensed under the Apache License, Version 2.0 (the “License”); you may not use this file except in compliance with the License.

You may obtain a copy of the License at: <http://www.apache.org/licenses/LICENSE-2.0>

Unless required by applicable law or agreed to in writing, software distributed under the License is distributed on an “AS IS” BASIS, WITHOUT WARRANTIES OR CONDITIONS OF ANY KIND, either express or implied.

See the License for the specific language governing permissions and limitations under the License.

A DOBOZ TARTALMA

Tartalom.....	13
---------------	----

BOSE MUSIC ALKALMAZÁS

A Bose Music alkalmazás letöltése	14
A fejhallgató hozzáadása egy meglévő fiókhhoz	14

A FEJHALLGATÓ VEZÉRLŐI

Bekapcsolás	16
Készenléti időzítő	16
Kikapcsolás.....	17
A fejhallgató funkciói.....	18
Médialejátszás és hangerő	18
Telefonhívások	19
Művelet gomb	20

ZAJKIOLTÁS

Zajkioltó módok	21
A zajkioltó mód megváltoztatása.....	21

HANGVEZÉRLÉS

A hangvezérlés elérése.....	22
-----------------------------	----

BLUETOOTH®-KAPCSOLATOK

Csatlakoztatás a mobilkészítők <i>Bluetooth</i> menüjének használatával.....	23
Mobilkészítők leválasztása	25
Mobilkészítők újbóli csatlakoztatása.....	25
Másik mobilkészítők csatlakoztatása	25
A csatlakoztatott mobilkészítők azonosítása	25
Váltás két csatlakoztatott mobilkészítők között	25
Korábban csatlakoztatott eszköz újrcsatlakoztatása.....	26
A fejhallgató eszközlistájának törlése.....	26

VEZETÉKES KAPCSOLATOK

Az audiokábel csatlakoztatása.....	27
------------------------------------	----

AKKUMULÁTOR

A fejhallgató feltöltése.....	28
Töltési idő.....	28
Az akkumulátor töltöttségi szintjének meghallgatása.....	28

A FEJHALLGATÓ ÁLLAPOTA

<i>Bluetooth</i> -állapot	29
Akkumulátor állapota	29
Töltési állapot	30
Frissítési és hibaállapotok	30

BOSE TERMÉKEK CSATLAKOZTATÁSA

Bose Home Speaker hangszóró vagy hangsugárzó csatlakoztatása.....	31
Előnyök	31
Kompatibilis termékek.....	31
Csatlakoztatás a Bose Music alkalmazás segítségével	31
Újracsatlakozás a Bose Smart Speaker hangszóróhoz vagy a Soundbar hangsugárzóhoz	32

ÁPOLÁS ÉS KARBANTARTÁS

A fejhallgató tárolása	33
A fejhallgató tisztítása	34
Cserealkatrészek és tartozékok.....	34
Korlátozott garancia.....	34
A gyári szám helye	35

HIBAELHÁRÍTÁS

Először próbálkozzon ezekkel a megoldásokkal	36
Egyéb megoldások.....	36
A fejhallgató visszaállítása a gyári alapértékekre	39

TARTALOM

Ellenőrizze a következő összetevők meglétét:



Bose QuietComfort 45 headphones

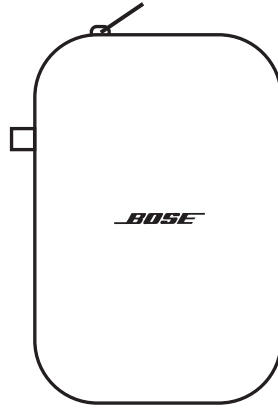

Puha hordtok

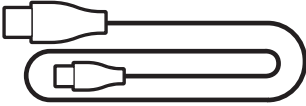

USB Type-C® típusú kábel

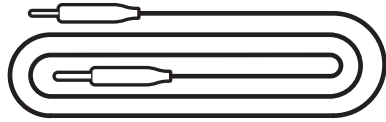

3,5 mm > 2,5 mm-es audiokábel

MEGJEGYZÉS: Ha a termék bármelyik részén sérülést tapasztal, ne használja a terméket. Forduljon a Bose hivatalos viszonteladójához, vagy a Bose ügyfélszolgálatához.

Látogasson el a következő címre: support.Bose.com/QCSE

A Bose Music alkalmazással a fejhallgatót bármely mobil eszközről (például okostelefonról vagy táblagépről) beállíthatja és vezérelheti.

Az alkalmazás segítségével kezelheti a *Bluetooth*-kapcsolatokat és a fejhallgató beállításait, kiválaszthatja a hangsegéd nyelvét és a frissítés révén új funkciókhoz férhet hozzá.

MEGJEGYZÉS: Ha már létrehozott egy Bose Music-fiókot egy másik Bose termékhez, adja hozzá a fejhallgatót a meglévő fiókjához (lásd a 14. oldal alján).

A BOSE MUSIC ALKALMAZÁS LETÖLTÉSE

1. Töltse le mobil eszközére a Bose Music alkalmazást.

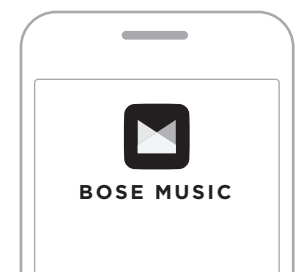

2. Kövesse az alkalmazás utasításait.

A FEJHALLGATÓ HOZZÁADÁSA EGY MEGLÉVŐ FIÓKHOZ

A Bose QuietComfort 45 fejhallgató hozzáadásához nyissa meg a Bose Music alkalmazást, és adja hozzá a fejhallgatót.

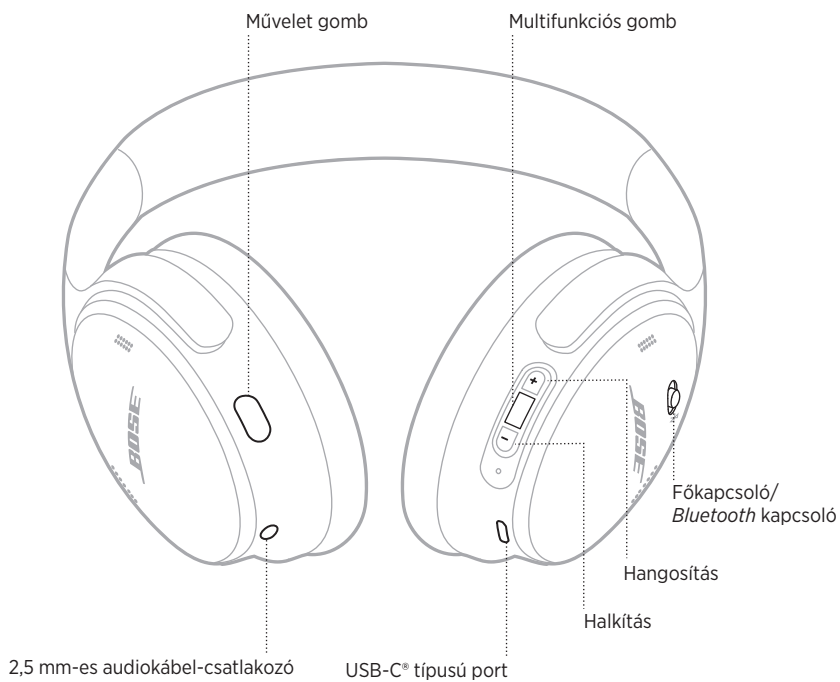

BEKAPCSOLÁS

A jobb oldali fejhallgatón csúsztassa el jobbra a Főkapcsoló/*Bluetooth* kapcsolót.

Hangutasítás jelzi az akkumulátor töltöttségi szintjét, és az állapotjelző fény az aktuális töltöttségi szintnek megfelelően világít (lásd: 29. oldal).



Készenléti időzítő

Amikor a fejhallgatót nem használja, a készenléti időzítővel megőrizheti az akkumulátor töltöttségét.

A készenléti időzítőt a Bose Music alkalmazással állíthatja be és módosíthatja.

KIKAPCSOLÁS

Csúsztassa el balra a Főkapcsoló/*Bluetooth* kapcsolót.



MEGJEGYZÉS: Amikor a fejhallgató ki van kapcsolva, a hangkioltási funkció le van tiltva.

A FEJHALLGATÓ FUNKCIÓI

A fejhallgató vezérlői a jobb oldali fülpárna hátulján találhatóak.

Médialejátszás és hangerő

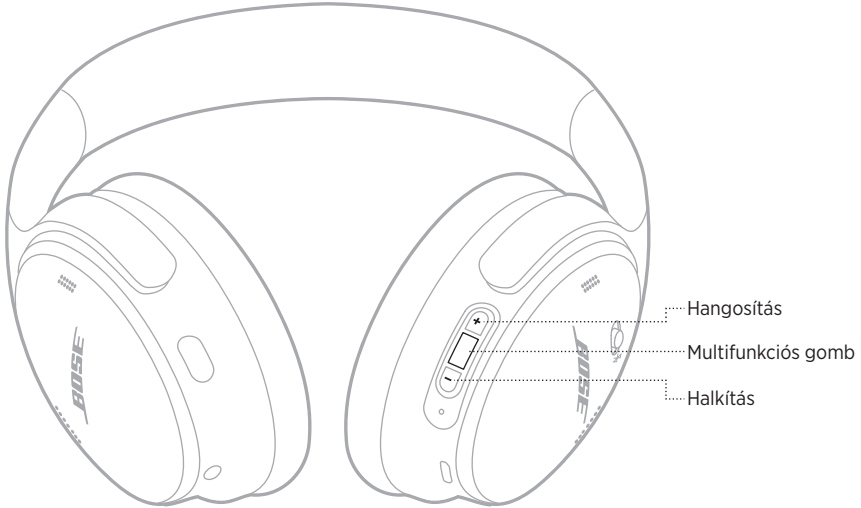

FUNKCIÓ	TEENDŐ
Lejátszás/szünet	Nyomja meg a multifunkciós gombot.
Ugrás előre	Nyomja meg kétszer a multifunkciós gombot.
Ugrás vissza	Nyomja meg háromszor a multifunkciós gombot.
Hangosítás	Nyomja meg a + gombot.
Halkítás	Nyomja meg a – gombot.

MEGJEGYZÉSEK:

- A hangerő gyors növeléséhez tartsa lenyomva a + gombot.
- A hangerő gyors csökkentéséhez tartsa lenyomva a – gombot.

Telefonhívások

A Multifunkciós gomb a jobb oldali fülpárna hátulján található. A mikrofon a jobb oldali fülpárna elejénél található.

A Művelet gomb a bal oldali fülpárna hátulján található.

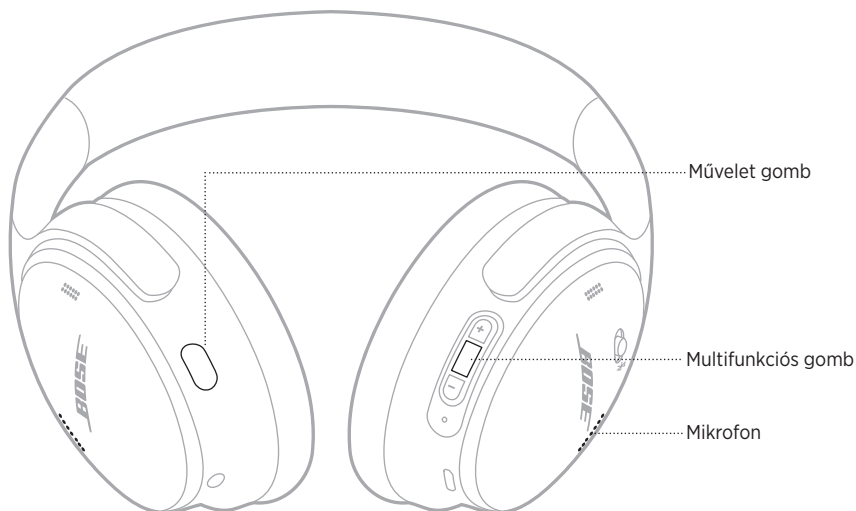

FUNKCIÓ	TEENDŐ
Hívás fogadása/befejezése	Nyomja meg a multifunkciós gombot.
Bejövő hívás elutasítása	Tartsa lenyomva a multifunkciós gombot 1 másodpercig.
Második bejövő hívás fogadása, és az első hívás várakoztatása	Amikor hívás közben beérkezik egy másik hívás, nyomja meg a multifunkciós gombot.
Második bejövő hívás elutasítása, és az első hívás folytatása	Amikor hívás közben beérkezik egy másik hívás, tartsa lenyomva a multifunkciós gombot 1 másodpercig.
Váltás két hívás között	Amikor két hívás aktív, nyomja meg kétszer a multifunkciós gombot.
Konferenciahívás létrehozása	Amikor két hívás aktív, tartsa lenyomva a multifunkciós gombot 3 másodpercig.
Hívás némitása/némitás megszüntetése	Hívás közben nyomja meg kétszer a Művelet gombot.

Művelet gomb

A Művelet gombbal gyorsan és egyszerűen válthat a zajkioltó módok között.

A Művelet gomb a bal oldali fülpárna hátulján található.

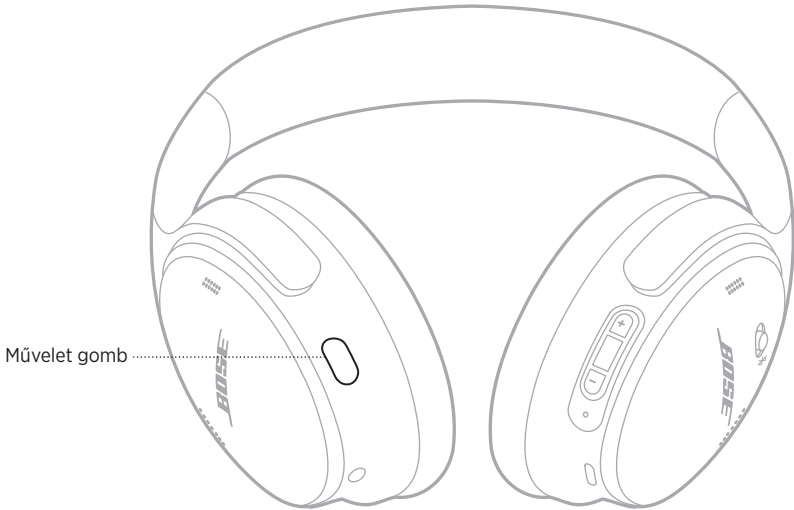

A Halk mód és az Éber mód közötti váltáshoz nyomja meg a Művelet gombot.

A zajkioltó módokról a következő helyen olvashat: 21. oldal.

A zajkioltó funkció a nemkívánatos zajok kiszűrésével tisztább, életszerűbb hangélményt biztosít. Két zajkioltó mód közül választhat: Halk és Éber.

Halk módban a legmagasabb zajkioltási szint használatával kizárhatja a zavaró hangokat.

Az Éber mód teljes áthallhatóságot biztosít, így zenehallgatás közben hallja környezetének hangjait is.

Válassza ki a saját igényeinek és környezetének megfelelő zajkioltási módot.

ZAJKIOLTÓ MÓDOK

ÜZEMMÓD	LEÍRÁS
Halk	Világszínvonalú zajkioltás a Bose optimalizált hangjával.
Éber	Zenehallgatás közben hallhatja a környezetét.

MEGJEGYZÉS: Bekapcsoláskor a fejhallgató alapértelmezés szerint az utoljára használt módot választja.

A ZAJKIOLTÓ MÓD MEGVÁLTOZTATÁSA

A zajkioltó mód megváltoztatásához nyomja meg a Művelet gombot.

A hangutasítás jelzi a kiválasztott zajkioltó módot.

TIPP: A zajkioltó módot a Bose Music alkalmazás segítségével is módosíthatja.

A HANGVEZÉRLÉS ELÉRÉSE

A fejhallgatóval használhatja a mobileszköz hangvezérlési funkcióját. A hangvezérlés eléréséhez tartsa lenyomva a multifunkciós gombot 1 másodpercig.

A Multifunkciós gomb a jobb oldali fülpárna hátulján található.

MEGJEGYZÉS: Hívás közben a hangvezérlés nem érhető el.

CSATLAKOZTATÁS A MOBILESZKÖZ BLUETOOTH MENÜJÉNEK HASZNÁLATÁVAL

A fejhallgató az eszközlistán akár nyolc mobileszkört is képes tárolni, és a fejhallgató egyszerre két eszközhöz tud aktívan csatlakozni. Egyszerre csak egy eszközről lehet zenét lejátszani.

MEGJEGYZÉS: A legjobb eredmény érdekében a mobileszköz beállításához és csatlakoztatásához használja a Bose Music alkalmazást (lásd: 14. oldal).

1. Csúsztassa el jobbra a Főkapcsoló/*Bluetooth* (⌘) gombot, és 3 másodpercig tartsa ott.

Ekkor meghallja a „Csatlakoztatásra kész” üzenetet, és az állapotjelző fény kéken villog.



2. Kapcsolja be az eszközén a *Bluetooth* funkciót.

MEGJEGYZÉS: A *Bluetooth* funkció általában a Beállítások menüben található.

3. Válassza ki fejhallgatóját az eszközlístáról.

TIPP: Keresse meg azt a nevet, amelyet a fejhallgatóhoz megadott a Bose Music alkalmazásban. Ha a fejhallgatónak nem adott nevet, az alapértelmezett neve fog megjelenni.



A párosítás után hallani fogja a „Csatlakoztatva a következőhöz: <eszköz neve>” üzenetet, és az állapotjelző fény kéken fog világítani 10 másodpercig.

MOBILESZKÖZ LEVÁLASZTÁSA

A mobilkészítész leválasztásához használja a Bose Music alkalmazást.

TIPP: Használhatja továbbá a *Bluetooth*-beállításokat az eszköz leválasztásához. Ha letiltja a *Bluetooth* funkciót, az összes eszköz kapcsolata megszűnik.

MOBILESZKÖZÖK ÚJBÓLI CSATLAKOZTATÁSA

Bekapcsoláskor a fejhallgató megpróbál újracsatlakozni a legutoljára használt két eszközhöz.

MEGJEGYZÉSEK:

- Az eszköznek 9 méteren belül, bekapcsolva kell lennie.
- Ellenőrizze, hogy a mobilkészítészén engedélyezte-e a *Bluetooth* funkciót.

MÁSİK MOBILESZKÖZ CSATLAKOZTATÁSA

Másik eszköz csatlakoztatásához töltsse le a Bose Music alkalmazást (lásd: 14. oldal), vagy használja a mobilkészítész *Bluetooth* menüjét (lásd: 23. oldal).

MEGJEGYZÉS: Egyszerre csak egy eszközhöz lehet zenét lejátszani.

A CSATLAKOZTATOTT MOBILESZKÖZÖK AZONOSÍTÁSA

Csúsztassa el jobbra a Főkapcsoló/*Bluetooth* kapcsolót (⌘), majd az éppen csatlakoztatott eszköz meghallgatásához engedje fel.

VÁLTÁS KÉT CSATLAKOZTATOTT MOBILESZKÖZ KÖZÖTT

1. Állítsa le a zenét az első mobilkészítészén.
2. Indítsa el a zenét a második mobilkészítészén.

MEGJEGYZÉS: A fejhallgató mindkét eszközhöz képes telefonhívást fogadni, függetlenül attól, hogy éppen melyik játszik le zenét.

KORÁBBAN CSATLAKOZTATOTT ESZKÖZ ÚJRACSATLAKOZTATÁSA

1. Csúsztassa el jobbra a Főkapcsoló/*Bluetooth* kapcsolót (⌘), majd az éppen csatlakoztatott eszköz meghallgatásához engedje fel.
2. 2 másodpercen belül csúsztassa a Főkapcsoló/*Bluetooth* kapcsolót (⌘) jobbra, majd engedje fel ismét a fejhallgató eszközlistáján lévő következő eszközhöz kapcsolódáshoz.
3. Ismételje ezt a lépést mindaddig, amíg a megfelelő eszköz nevét meg nem hallja. Hangjelzést fog hallani, amikor az eszköz csatlakoztatása megtörtént.
4. Indítsa el a zenét a csatlakoztatott mobilkészüléken.

MEGJEGYZÉS: Ha a fejhallgatóhoz már csatlakozik két eszköz, az újonnan csatlakoztatott készülék az előzőleg kapcsolódó második eszközt fogja lecserélni.

A FEJHALLGATÓ ESZKÖZLISTÁJÁNAK TÖRLÉSE

1. Csúsztassa el jobbra a Főkapcsoló/*Bluetooth* kapcsolót (⌘), és tartsa ott 15 másodpercig, amíg meg nem hallja a „*Bluetooth*-eszköz listájának tartalma törölve. Készen áll a kapcsolódásra.” üzenetet.
2. Törölje a fejhallgatókat a mobilkészüléken található *Bluetooth*-listáról.
Az összes eszköz törlődik, és a fejhallgató készen áll a csatlakoztatásra.

AZ AUDIOKÁBEL CSATLAKOZTATÁSA

A mellékelt 2,5 mm > 3,5 mm-es kábel segítségével csatlakoztathat egy vezetékes eszközt, vagy folytathatja a fejhallgató használatát, ha az akkumulátor lemerült.

1. Dugja be a kábelt a bal fülpárnán lévő 2,5 mm-es csatlakozóba.



2. Dugja be a kábel másik végét az eszköz 3,5 mm-es csatlakozójába.

MEGJEGYZÉS: A fejhallgatót használhatja be- és kikapcsolt állapotban is, amikor a hangkábel csatlakoztatva van.

A FEJHALLGATÓ FELTÖLTÉSE

1. Dugja be az USB-kábel kisebbik végét a fejhallgató jobb fülpárnáján lévő USB-C-portba.
2. A kábel másik végét csatlakoztassa egy fali USB-csatlakozóba.



MEGJEGYZÉSEK:

- Amikor a fejhallgató elkezd tölteni, az állapotjelző fény 10 másodpercig fehéren villog. Amikor teljesen feltöltődött, az állapotjelző fény folyamatosan fehéren világít.
- A fejhallgató töltés közben nem szól.

Töltési idő

A fejhallgatók teljes feltöltése legfeljebb 2,5 órát vesz igénybe.

Az akkumulátor töltöttségi szintjének meghallgatása

A fejhallgató minden egyes bekapcsolásakor hangutasítást hall, amely tájékoztatja az akkumulátor töltöttségi szintjéről. Ha a fejhallgató akkumulátorszintje alacsony, az „Alacsony töltöttség. Töltés szükséges.” üzenetet fogja hallani.

MEGJEGYZÉS: Ha látni szeretné az akkumulátor állapotát, nézze meg a fejhallgató jobb fülpárnáján lévő állapotjelző fényt. További információk: „Akkumulátor állapota”, 29. oldal.

Az állapotjelző fény a jobb oldali fejhallgatón található.



BLUETOOTH-ÁLLAPOT

A *Bluetooth*-kapcsolat állapotát mutatja.

FÉNYJELZÉS	RENDSZERÁLLAPOT
Kéken villog	Készen áll a kapcsolódásra
Folyamatos kék (10 másodperc)	Csatlakoztatva

AKKUMULÁTOR ÁLLAPOTA

Jelzi az akkumulátor töltöttségi szintjét.

FÉNYJELZÉS	RENDSZERÁLLAPOT
Folyamatosan fehéren világít	Töltöttség a közepes és a teljes szint között
Folyamatos sárga	Alacsony töltöttség

TIPP: Az akkumulátor töltöttségi szintjét a Bose Music alkalmazással is ellenőrizheti.

TÖLTÉSI ÁLLAPOT

A töltés állapotát mutatja.

FÉNYJELZÉS	RENDSZERÁLLAPOT
Kétszer fehéren villog	Megkezdődik a töltés
Folyamatos sárga	Töltés folyamatban
Folyamatosan fehéren világít	Teljesen feltöltve

FRISSÍTÉSI ÉS HIBAÁLLAPOTOK

A frissítési vagy a hibaállapotokat mutatja.

FÉNYJELZÉS	RENDSZERÁLLAPOT
Gyorsan villogó fehér (10 másodperc)	Szoftver frissítése (USB-n keresztül)
Lassan villogó fehér (30–60 másodperc)	Szoftver frissítése (vezeték nélkül)
Sárga-fehér villogás	Hiba. Hívja a Bose ügyfélszolgálatát

BOSE HOME SPEAKER HANGSZÓRÓ VAGY HANGSUGÁRZÓ CSATLAKOZTATÁSA

A Bose SimpleSync™ technológiájának köszönhetően mostantól csatlakoztathatja a fejhallgatóját a Bose Smart Soundbar hangsugárzóhoz vagy a Bose Smart Speaker hangszóróhoz, és így személyesebb hangélményben lehet része.

Előnyök

- Az egyes termékek független hangerőszabályzóival lehalkíthatja vagy elnémíthatja a Bose Smart Soundbar hangsugárzót, míg a fejhallgatóból érkező hangokat továbbra is olyan hangerőn hallgathatja, amilyenén szeretné.
- A zenét a másik szobából is tisztán hallhatja, ha a fejhallgatót a Bose Smart Speaker hangszóróhoz csatlakoztatja.

MEGJEGYZÉS: A SimpleSync™ technológia vezeték nélküli *Bluetooth*-hatósugara legfeljebb 9 méter. A falak vastagsága és anyaga befolyásolhatja a jelek fogadását.

Kompatibilis termékek

A fejhallgatót bármely Bose Smart Speaker hangszóróhoz vagy Bose Smart Soundbar hangsugárzóhoz csatlakoztathatja.

Néhány népszerű kompatibilis termék:

- Bose Smart Soundbar 700/Bose Soundbar 700
- Bose Soundbar 500
- Bose Smart Speaker 500/Bose Home Speaker 500
- Bose Home Speaker 300
- Bose Portable Smart Speaker/Bose Portable Home Speaker

A lista rendszeresen új termékekkel bővül. A teljes listát és a további információkat a következő címen tekintheti meg: worldwide.Bose.com/Support/Groups

Csatlakoztatás a Bose Music alkalmazás segítségével

1. A fejhallgatón csúsztassa el jobbra a Főkapcsoló/*Bluetooth* (⌘) gombot, és 3 másodpercig tartsa ott.

Ekkor meghallja a „Másik eszköz csatlakoztatására kész” üzenetet, és az állapotjelző fény kéken villog.

2. A Bose Music alkalmazással csatlakoztassa a fejhallgatót egy kompatibilis Bose termékhez. További információért látogasson el a következő címre: worldwide.Bose.com/Support/Groups

MEGJEGYZÉSEK:

- Ügyeljen arra, hogy a fejhallgató legfeljebb 9 méterre legyen a hangsugárzótól vagy a hangszórótól.
- A fejhallgató egyszerre csak egy eszközhöz csatlakoztatható.

ÚJRACSATLAKOZÁS A BOSE SMART SPEAKER HANGSZÓRÓHOZ VAGY A SOUNDBAR HANGSUGÁRZÓHOZ

Kapcsolja be a fejhallgatót (lásd: „Bekapcsolás”, 16. oldal).

A fejhallgató megpróbál kapcsolódni a két utoljára csatlakoztatott *Bluetooth*-eszközhöz, ideértve a hangsugárzót és a hangszórót is.

MEGJEGYZÉSEK:

- A hangsugárzónak vagy a hangszórónak 9 méteren belül, bekapcsolva kell lennie.
- Ha a fejhallgató nem kapcsolódik újra, lásd: „A fejhallgató nem kapcsolódik újra a korábban csatlakoztatott Bose Smart Soundbar hangsugárzóhoz vagy a hangszóróhoz”, 38. oldal.

A FEJHALLGATÓ TÁROLÁSA

A kényelmes, egyszerű tárolás érdekében a fülpárnák elforgathatók. Helyezze a fejhallgatót lapos állapotban a dobozába.

1. Forgassa el mindkét fülpárnát úgy, hogy egy síkban legyenek.

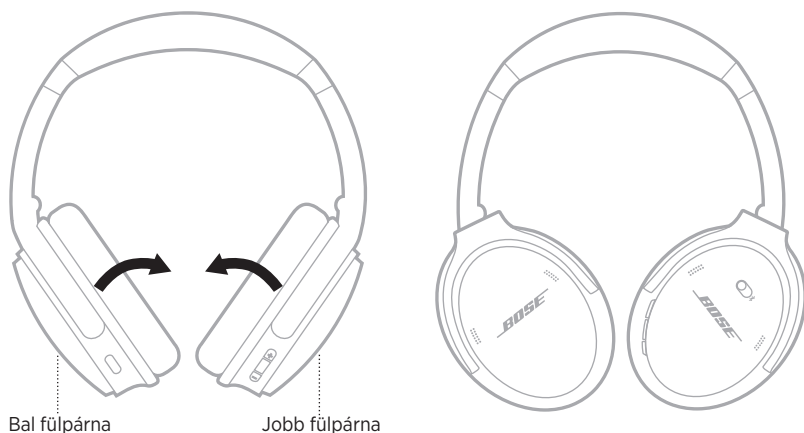

2. A bal oldali fülpárnát forgassa felfelé a fejpánt felé.

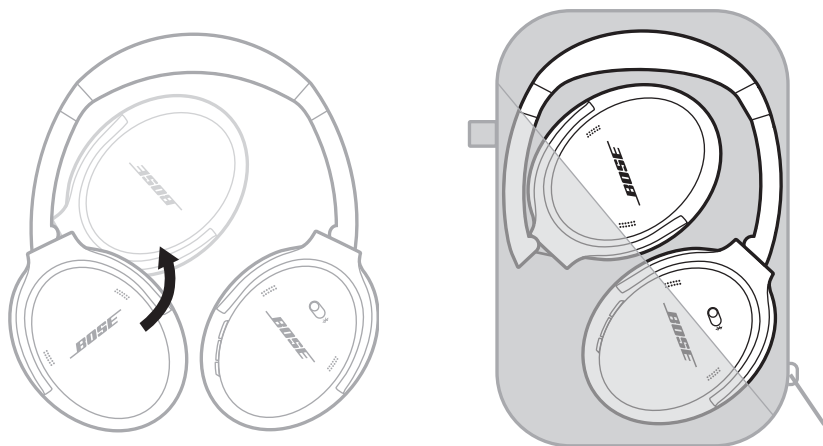

MEGJEGYZÉSEK:

- Kapcsolja ki a fejhallgatót, amikor nem használja.
- Ha több hónapig nem fogja használni a fejhallgatót, akkor teljesen feltöltött akkumulátorral tegye el.

A FEJHALLGATÓ TISZTÍTÁSA

Törölje le a külső felületeket egy puha, száraz ronggyal.

Ne engedje, hogy nedvesség jusson a fejhallgatók belsejébe.

CSEREALKATRÉSZEK ÉS TARTOZÉKOK

A cserealkatrészek vagy tartozékok a Bose ügyfélszolgálatán keresztül rendelhetők meg. Látogasson el a következő címre: support.bose.com/QCSE

KORLÁTOZOTT GARANCIA

A fejhallgatóra korlátozott garancia vonatkozik. A korlátozott garancia részleteit a global.bose.com/Warranty webhelyen olvashatja.

A termék regisztrálására vonatkozó tudnivalókat a global.bose.com/ProductRegistration címen találja. A regisztráció elmulasztása nem befolyásolja a korlátozott garanciára való jogosultságát.

A GYÁRI SZÁM HELYE

A gyári szám a jobb fejhallgató belsejében, a bélés alatt található. A bélésszövet a fülpárnák belső részeit takaró és védő belső szövet.

A gyári szám megtekintéséhez fogja meg a bélésszövet felső szélét, és óvatosan húzza le.

VIGYÁZAT: Ügyeljen rá, hogy ne nyomja meg vagy távolítsa el a fülpárnák belsejében található alkatrészeket, mert ez a fejhallgató sérüléséhez vezethet.

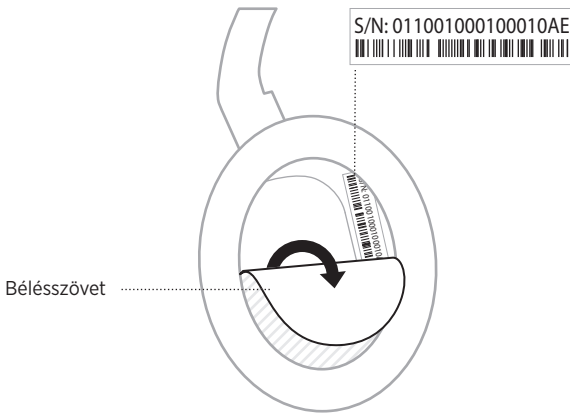

ELŐSZÖR PRÓBÁLKOZZON EZEKEL A MEGOLDÁSOKKAL

Ha a fejhallgatóval kapcsolatban problémákat észlel:

- Ellenőrizze az állapotjelző fény állapotát (lásd: 29. oldal).
- Töltse fel az akkumulátort (lásd: 28. oldal).
- Növelje a fejhallgató, a mobilkészít és a zenei alkalmazás hangerejét.
- Töltse le a Bose Music alkalmazást, és futtassa az elérhető frissítéseket (lásd: 14. oldal).
- Próbáljon másik mobilkészítet csatlakoztatni (lásd: 25. oldal).

Ha a hibát nem sikerült elhárítani, az alábbi táblázat segítségével azonosítsa az észlelt jelenséget, és a leggyakoribb problémák megoldásait. Ha a problémát nem tudja megoldani, forduljon a Bose ügyfélszolgálatához.

Látogasson el a következő címre: worldwide.Bose.com/contact

EGYÉB MEGOLDÁSOK

JELENSÉG	MEGOLDÁS
A fejhallgató nem kapcsolódik be	Töltse fel az akkumulátort.
A fejhallgató nem csatlakoztatható a mobilkészítökhöz	Húzza ki a kiegészítö hangkábelét. Húzza ki az USB-töltökábelét. A mobilkészítön: Tiltsa le, majd engedélyezze ismét a <i>Bluetooth</i> funkciót. Törölje a Bose QuietComfort 45 fejhallgatót az eszközén található <i>Bluetooth</i> -listáról, ideértve az „LE” (Low Energy) jelölésű duplikált bejegyzéseket is. Csatlakoztassa ismét. Vigye közelebb a mobilkészítöt a fejhallgatóhoz, és vigye távolabb minden zavarforrástól vagy a jelet árnyékoló akadálytól. A bemutató videók megtekintéséhez látogasson el a support.Bose.com/QCSE címre. Törölje a csatlakoztatott eszközök listájának tartalmát (lásd: 26. oldal), majd hajtsa végre ismét a csatlakoztatást.
Az akkumulátor nem töltödik	Ellenőrizze az USB-töltökábel mindkét végének csatlakozását. Próbáljon másik forrást használni a töltéshez. Ha a fejhallgató túl magas vagy túl alacsony hőmérsékletnek volt kitéve, várja meg, amíg újra eléri a szobahőmérsékletet, majd próbálja újból feltölteni.

JELENSÉG	MEGOLDÁS
Nincs hang	<p>Kapcsolja be a fejhallgatót, és töltsse fel az akkumulátort.</p> <p>Ellenőrizze az állapotjelző fény állapotát (lásd: 29. oldal).</p> <p>Csúsztassa el a Főkapcsoló/<i>Bluetooth</i> gombot jobbra, és engedje el, hogy hallja a csatlakoztatott mobilkészítő nevét. Ellenőrizze, hogy a megfelelő eszközt használja-e.</p> <p>Vigye közelebb a mobilkészítőt a fejhallgatóhoz, és vigye távolabb minden zavarforrástól vagy a jelet árnyékoló akadálytól.</p> <p>Használjon egy másik zenei forrást.</p> <p>Ha két eszközt van csatlakoztatva, először szüneteltesse a lejátszást a másik mobilkészítőn.</p> <p>Ha két mobilkészítőt is csatlakozik, helyezze az eszközöket a fejhallgató hatótávolságán (9 méter) belülre.</p> <p>Próbálkozzon a mobilkészítőn helyileg tárolt zenei vagy videófájllal.</p>
Gyenge a hangminőség	<p>Használjon egy másik zenei forrást.</p> <p>Csatlakoztasson egy másik mobilkészítőt (lásd: 25. oldal).</p> <p>Válassza le a másik eszközt.</p> <p>Vigye közelebb a mobilkészítőt a fejhallgatóhoz, és vigye távolabb minden zavarforrástól vagy a jelet árnyékoló akadálytól.</p> <p>Próbálkozzon a mobilkészítőn helyileg tárolt zenei vagy videófájllal.</p>
Nem hallható hang a tartalék audiokábelrel csatlakoztatott eszközből	<p>Ellenőrizze a kiegészítő hangkábel mindkét végének csatlakozását.</p> <p>Növelje a fejhallgató, a mobilkészítő és a zenei forrás hangerejét.</p> <p>Csatlakoztasson egy másik eszközt (lásd: 25. oldal).</p>
A hangkábelrel csatlakoztatott eszközről gyenge minőségű hang hallható	<p>Ellenőrizze a kiegészítő hangkábel mindkét végének csatlakozását.</p> <p>Csatlakoztasson egy másik eszközt (lásd: 25. oldal).</p>
A Művelet gomb nem módosítja a zajkioltó módot	<p>Ellenőrizze, hogy a fejhallgató be van-e kapcsolva.</p> <p>A Bose Music alkalmazás használatával módosítsa a zajkioltó módot.</p>

JELENSÉG	MEGOLDÁS
A fejhallgató nem kapcsolódik a Bose Smart Soundbar hangszugárzóhoz vagy a hangszóróhoz	Csúsztassa el és tartsa a Főkapcsoló/ <i>Bluetooth</i> gombot mindaddig, amíg a „Másik eszköz csatlakoztatására kész” üzenet el nem hangzik, és a <i>Bluetooth</i> jelzőfénye kéken nem villog. Ügyeljen arra, hogy a fejhallgató legfeljebb 9 méterre legyen a hangszugárzótól vagy a hangszórótól.
A fejhallgató nem kapcsolódik újra a korábban csatlakoztatott Bose Smart Soundbar hangszugárzóhoz vagy a hangszóróhoz	Csatlakoztasson újra egy korábban csatlakoztatott eszközt (lásd: 26. oldal).
A hang késik, amikor a fejhallgató a Bose Smart Soundbar hangszugárzóhoz vagy a hangszóróhoz csatlakozik	Töltse le a Bose Music alkalmazást, és futtassa az elérhető frissítéseket.

A gyári alapértékek visszaállításával törölheti az összes beállítást, és a fejhallgatót visszaállíthatja az eredeti állapotába. Ezután elvégezheti a fejhallgató konfigurálását, mint ahogyan a legelső használatba vétel alkalmával tette.

A gyári alapértékek visszaállítása csak akkor javasolt, ha problémái vannak a fejhallgatóval, vagy ha a Bose ügyfélszolgálati képviselője arra kérte.

A FEJHALLGATÓ VISSZAÁLLÍTÁSA A GYÁRI ALAPÉRTÉKEKRE

1. Távolítsa el a fejhallgatót az eszközön található *Bluetooth*-listáról.
2. Távolítsa el a fejhallgatót a Bose Music-fiókjából a Bose Music alkalmazással.

MEGJEGYZÉS: További információkat azzal kapcsolatban, hogy hogyan távolíthatja el a fejhallgatót a Bose Music-fiókjából a Bose Music alkalmazással, látogasson el a következő címre: worldwide.Bose.com/Support/QCSE

3. Csúsztassa el jobbra a Főkapcsoló/*Bluetooth* (⌘) gombot, és tartsa ott. Ezzel egy időben tartsa lenyomva a Művelet gombot 30 másodpercig.

Az állapotjelző fény fehéren villog. 30 másodperc elteltével az állapotjelző fény sárgán villog, ami jelzi, hogy a gyári alapértékek visszaállítása folyamatban van (2-3 másodperc).

4. Amikor a visszaállítás befejeződött, az állapotjelző lassan, kéken villog. A fejhallgató beállításai visszaálltak az eredeti gyári értékekre.

Les og ta vare på alle sikkerhets- og bruksinstruksjoner.

CE Bose Corporation erklærer hermed at dette produktet oppfyller grunnleggende krav og andre relevante bestemmelser i direktiv 2014/53/EU og alle andre relevante krav i EU-direktiver. Den fullstendige samsvarserklæringen finner du på www.Bose.com/compliance

UK CA Dette produktet er i samsvar med alle gjeldende bestemmelser om elektromagnetisk kompatibilitet for 2016 og alle andre gjeldende bestemmelser i Storbritannia. Den fullstendige samsvarserklæringen finner du på www.Bose.com/compliance

Bose Corporation kunngjør herved at dette produktet er i samsvar med de essensielle kravene i bestemmelser for radioutstyr for 2017 og alle andre gjeldende bestemmelser i Storbritannia. Den fullstendige samsvarserklæringen finner du på www.Bose.com/compliance

Viktige sikkerhetsinstruksjoner

Ikke bruk apparatet i eller nær vann.

Rengjør bare med en ren klut.

Overlat all service til kvalifisert personell. Apparatet trenger service når det er skadet, for eksempel når ledningen eller kontakten til strømforsyningen er skadet, det er sølt væske på apparatet eller gjenstander har falt inn i det, apparatet har blitt utsatt for regn eller fuktighet, det ikke fungerer slik det skal, eller det har falt i bakken.

ADVARSLER/FORHOLDSREGLER

- IKKE bruk hodetelefonene på høyt volum i lengre tid.
 - Hvis du vil unngå hørselsskader, må du bruke hodetelefonene på et komfortabelt, moderat volumnivå.
 - Skru volumet ned på enheten før du plasserer hodetelefonene i/på ørene, og skru deretter volumet opp gradvis til et komfortabelt lyttenivå.
- IKKE bruk hodetelefonene til telefonsamtaler eller andre formål når du kjører bil.
- IKKE bruk hodetelefonene med støyreduksjonsmodus når det kan være farlig å ikke høre omgivelseslyder, for eksempel mens du sykler eller går i eller nær trafikk, en byggeplass eller en jernbane osv. Følg alltid gjeldende lover angående bruken av hodetelefoner.
 - Slå hodetelefonene av eller bruk dem med støyreduksjon deaktivert, og juster volumet for å sikre at du kan høre lyder fra omgivelsene, herunder alarmer og varslingssignaler.
 - Vær oppmerksom på hvordan lyder du bruker som påminnelser eller varsling, kan variere når du bruker hodetelefonene, også i oppmerksomhetsmodus.
- IKKE bruk hodetelefonene hvis de avgir en høy, uvanlig lyd. Slå av hodetelefonene og kontakt kundestøtte for Bose hvis dette skjer.
- Ta av hodetelefonene umiddelbart hvis det oppstår en varmfølelse eller hørselstap.
- IKKE koble hodetelefonene til adaptere beregnet for mobiltelefon på setekontakter i fly. Dette kan føre til personskade eller skade på eiendeler på grunn av overoppheting.
- IKKE bruk hodetelefonene til luftfartskommunikasjon.



Inneholder små deler som kan utgjøre fare for kvelling. Ikke egnet for barn under 3 år.



Dette produktet inneholder magnetisk materiale. Kontakt lege hvis du vil finne ut om dette kan påvirke implantert medisinsk utstyr.

- For å redusere risikoen for brann eller elektrisk støt må du ikke utsette apparatet for regn, drypp, sprut eller fuktighet, og du må ikke plassere gjenstander fylt med væske, for eksempel vaser, på eller i nærheten av apparatet.
- Hold apparatet borte fra åpen ild og varmekilder. IKKE plasser kilder til åpen flamme, for eksempel tente stearinlys, på eller nær produktet.
- Dette produktet skal bare brukes med en LPS-strømforsyning som er godkjent av offentlige tilsynsmyndigheter, og som oppfyller lokale forskriftskrav (som UL, CSA, VDE, CCC).
- IKKE utfør uautoriserte endringer på produktet.
- Hvis batteriet lekker, må du ikke la væsken komme i kontakt med hud eller øyne. Oppsøk lege ved kontakt.
- Ikke utsett produkter som inneholder batterier, for høy temperatur (for eksempel direkte sollys, i nærheten av åpen ild eller lignende).
- IKKE bruk produktet mens det lades.

MERKNAD: Tester av utstyret viser at det overholder grenseverdiene for digitalt utstyr av klasse B, som beskrevet i del 15 av FCC-regelverket. Disse grenseverdiene er beregnet på å sikre rimelig beskyttelse mot skadelige radioforstyrrelser ved montering i boligmiljø. Utstyret genererer, bruker og kan avgi radiofrekvensenergi. Hvis det ikke monteres og brukes i overensstemmelse med instruksjonene, kan det forårsake skadelig forstyrrelse av radiokommunikasjon. Det kan likevel ikke garanteres at slik forstyrrelse ikke vil kunne oppstå ved en gitt montering. Dersom utstyret skulle forårsake skadelig forstyrrelse for radio- eller TV-mottak, hvilket kan avgjøres ved å slå det av og på igjen, er det følgende noe av det brukeren kan gjøre:

- Flytt eller snu mottakerproduktet eller antennen.
- Øk avstanden mellom utstyret og radio- eller TV-utstyret.
- Koble utstyret til en annen strømkrets enn den radio- eller TV-utstyret er koblet til.
- Ta kontakt med forhandleren eller en erfaren radio- eller TV-installatør for hjelp.

Endringer eller modifikasjoner som ikke er uttrykkelig godkjent av Bose Corporation, kan frata brukeren retten til å bruke utstyret.

Dette utstyret overholder del 15 av FCC-regelverket og med RSS-standard(er) med ISED Canada-lisensunntak. Bruk av utstyret er underlagt følgende to betingelser: (1) Utstyret skal ikke forårsake skadelig interferens, og (2) utstyret skal tåle all mottatt interferens, herunder interferens som kan føre til uønsket virkemåte for utstyret.

Dette utstyret samsvarer med radiostrålingsgrensene i FCC og ISED Canada som er angitt for den generelle befolkningen. Senderen må ikke plasseres på samme sted som eller brukes i forbindelse med andre antenner eller sendere.

Oppfyller IMDA-krav.

FCC-ID: A94437310

IC: 3232A-437310

CAN ICES-3(B) / NMB-3(B)

For Europa:

Frekvensbånd for bruk er 2400 til 2483,5 MHz.

Maksimal sendestyrke er mindre enn 20 dBm EIRP.

Maksimal sendestyrke er mindre enn forskriftsmessige grenser slik at SAR-testing ikke er nødvendig og unntatt i henhold til gjeldende bestemmelser.



Dette symbolet betyr at produktet ikke må kasseres som husholdningsavfall, og at det skal leveres inn til et passende gjenvinningsanlegg. Riktig håndtering og gjenvinning bidrar til å beskytte naturressurser, helse og miljø. Mer informasjon om avhending og resirkulering av dette produktet kan fås hos kommunen, renovasjonstjenesten eller butikken der du kjøpte dette produktet.

Tekniske forskrifter for radiofrekvensenheter med lav effekt

Firmaer, selskaper eller brukere som ikke har tillatelse fra NCC, har ikke lov til å endre frekvens, forbedre sendestyrke eller endre opprinnelige egenskaper eller opprinnelig ytelse for godkjente radiofrekvensenheter med lav effekt. Radiofrekvensenheter med lav effekt skal ikke påvirke flysikkerhet eller forstyrre lovlig kommunikasjon. Hvis dette skjer, skal brukeren avslutte driften umiddelbart til det ikke forekommer forstyrrelser. Juridisk sett betyr kommunikasjon radiokommunikasjon som drives i samsvar med loven om telekommunikasjon (Telecommunications Management Act). Radiofrekvensenheter med lav effekt må tåle interferens fra lovlig kommunikasjon eller enheter som avgir ISM-radiobølger.

IKKE prøv å fjerne det oppladbare litium-ion-batteriet fra produktet. Kontakt den lokale Bose-forhandleren eller andre kvalifiserte teknikere angående fjerning.

Det oppladbare litium-ion-batteriet i produktet må bare tas ut av kvalifiserte teknikere. Kontakt den lokale Bose-forhandleren eller gå til products.bose.com/static/compliance/index.html for å få mer informasjon.



Kasser brukte batterier på en miljøriktig måte i henhold til lokale bestemmelser. Må ikke brennes.



Navn på og innhold i giftige eller skadelige stoffer eller bestanddeler						
Delnavn	Giftige eller skadelige stoffer eller bestanddeler					
	Bly (Pb)	Kvikksølv (Hg)	Kadmium (Cd)	Heksavalent (CR(VI))	Polybromerte bifenyl (PBB)	Polybromerte difenyletere (PBDE)
PCB-er	X	0	0	0	0	0
Metaldeler	X	0	0	0	0	0
Plastdeler	0	0	0	0	0	0
Høytaler	X	0	0	0	0	0
Kabler	X	0	0	0	0	0
Denne tabellen er utarbeidet i henhold til krav i SJ/T 11364.						
O: Angir at dette giftige eller farlige stoffet som finnes i alle de homogene materialene i denne delen, er under grensekravene i GB/T 26572.						
X: Angir at dette giftige eller farlige stoffet som finnes i minst ett av de homogene materialene i denne delen, er over grensekravene i GB/T 26572.						

Produksjonsdato: Det åttende sifferet i serienummeret er produksjonsåret. 2 vil si 2012 eller 2022.

Importør for Kina: Bose Electronics (Shanghai) Company Limited, Level 6, Tower D, No. 2337 Gudai Rd. Minhang District, Shanghai 201100

Importør for EU: Bose Products B.V., Gorslaan 60, NL-1441 RG Purmerend, Nederland

Importør for Mexico: Bose de México S. de R.L. de C.V., Avenida Prado Sur #150, Piso 2, Interior 222 y 223, Colonia Lomas de Chapultepec V Sección, Miguel Hidalgo, Ciudad de México, C.P. 11000 Telefonnummer: +5255 (5202) 3545

Importør for Taiwan: Bose Limited Taiwan Branch (H.K.), 9F., No. 10, Sec. 3, Minsheng E. Road, Zhongshan Dist. Taipei City 10480, Taiwan Telefonnummer: +886-2-2514 7676

Importør for Storbritannia: Bose Limited, Bose House, Quayside Chatham Maritime, Chatham, Kent, ME4 4QZ, Storbritannia

Strømningang: 5 V --- 0,5 A

Ladetemperatur: 0 til 45 °C

Utladningstemperatur: -20 til +60 °C

Modell 437310. CMIIT-ID-en er plassert på innsiden av øreklokken under polstringen.

Fyll ut og oppbevar for senere bruk

Serie- og modellnummer er plassert inni øreklokken under polstringen.

Serienummer: _____

Modellnummer: _____

Oppbevar kvitteringen sammen med brukerhåndboken. Nå er en god anledning til å registrere Bose-produktet. Du kan gjøre dette ved å gå til worldwide.bose.com/ProductRegistration

Sikkerhetsinformasjon



Produktet kan motta sikkerhetsoppdateringer fra Bose automatisk når det er koblet til Bose Music-appen. Produktoppsettsprosessen i Bose Music-appen må gjennomføres for at produktet skal motta sikkerhetsoppdateringer gjennom mobilappen. **Hvis du ikke gjennomfører konfigureringsprosessen, er det ditt ansvar å installere sikkerhetsoppdateringene som Bose gjør tilgjengelig på btu.bose.com**

Apple, Apple-logoen, iPad, iPhone og iPod er varemerker som tilhører Apple Inc. og er registrert i USA og andre land. App Store er et tjenestemerke for Apple Inc. Varemerket iPhone brukes i Japan med lisens fra Aiphone K.K.

Bruk av Made for Apple-merket betyr at et tilbehør er konstruert spesifikt for tilkobling til Apple-produktene som angis i merket, og er sertifisert av utvikleren i henhold til Apples ytelsesstandarder. Apple er ikke ansvarlig for hvordan enheten fungerer eller hvordan den overholder sikkerhetsbestemmelser og andre standarder.

Ordmerket *Bluetooth*® og logoene er registrerte varemerker som tilhører Bluetooth SIG, Inc. All bruk som Bose Corporation gjør av disse varemerkene, er på lisens.

Google Play er et varemerke som tilhører Google LLC.

USB Type-C® og USB-C® er registrerte varemerker som tilhører USB Implementers Forum.

Bose, Bose Home Speaker, Bose Music, Bose Music-logoen, Bose Smart Soundbar, Bose Smart Speaker, Bose Soundbar, QuietComfort og SimpleSync er varemerker som tilhører Bose Corporation.

Hovedkontor for Bose Corporation: 1-877-230-5639

©2022 Bose Corporation. Ingen del av dette dokumentet kan reproduseres, endres, distribueres eller brukes på annen måte uten forutgående skriftlig tillatelse.

The following license disclosures apply to certain third-party software packages used as components in the product.

Package: FreeRTOS

Copyright © Amazon Web Services, Inc. or its affiliates. All rights reserved.

The FreeRTOS package is subject to the license terms reprinted below:

MIT License

Permission is hereby granted, free of charge, to any person obtaining a copy of this software and associated documentation files (the “Software”), to deal in the Software without restriction, including without limitation the rights to use, copy, modify, merge, publish, distribute, sublicense, and/or sell copies of the Software, and to permit persons to whom the Software is furnished to do so, subject to the following conditions:

The above copyright notice and this permission notice shall be included in all copies or substantial portions of the Software.

THE SOFTWARE IS PROVIDED “AS IS”, WITHOUT WARRANTY OF ANY KIND, EXPRESS OR IMPLIED, INCLUDING BUT NOT LIMITED TO THE WARRANTIES OF MERCHANTABILITY, FITNESS FOR A PARTICULAR PURPOSE AND NONINFRINGEMENT. IN NO EVENT SHALL THE AUTHORS OR COPYRIGHT HOLDERS BE LIABLE FOR ANY CLAIM, DAMAGES OR OTHER LIABILITY, WHETHER IN AN ACTION OF CONTRACT, TORT OR OTHERWISE, ARISING FROM, OUT OF OR IN CONNECTION WITH THE SOFTWARE OR THE USE OR OTHER DEALINGS IN THE SOFTWARE.

Package: Nanopb

Copyright © 2011 Petteri Aimonen <jpa at nanopb.mail.kapsi.fi>.

The Nanopb package is subject to the license terms reprinted below:

Zlib License

© 2011 Petteri Aimonen <jpa at nanopb.mail.kapsi.fi>

This software is provided ‘as-is’, without any express or implied warranty. In no event will the authors be held liable for any damages arising from the use of this software.

Permission is granted to anyone to use this software for any purpose, including commercial applications, and to alter it and redistribute it freely, subject to the following restrictions:

1. The origin of this software must not be misrepresented; you must not claim that you wrote the original software. If you use this software in a product, an acknowledgment in the product documentation would be appreciated but is not required.
2. Altered source versions must be plainly marked as such, and must not be misrepresented as being the original software.
3. This notice may not be removed or altered from any source distribution.

Package: Mbed TLS 2.16.1

© ARM Limited. All rights reserved.

The Mbed TLS package is subject to the license terms reprinted below:

Apache License

Version 2.0, January 2004

<http://www.apache.org/licenses/>

TERMS AND CONDITIONS FOR USE, REPRODUCTION, AND DISTRIBUTION

1. Definitions.
“License” shall mean the terms and conditions for use, reproduction, and distribution as defined by Sections 1 through 9 of this document.

“Licensor” shall mean the copyright owner or entity authorized by the copyright owner that is granting the License.

“Legal Entity” shall mean the union of the acting entity and all other entities that control, are controlled by, or are under common control with that entity. For the purposes of this definition, “control” means (i) the power, direct or indirect, to cause the direction or management of such entity, whether by contract or otherwise, or (ii) ownership of fifty percent (50%) or more of the outstanding shares, or (iii) beneficial ownership of such entity.

“You” (or “Your”) shall mean an individual or Legal Entity exercising permissions granted by this License.

“Source” form shall mean the preferred form for making modifications, including but not limited to software source code, documentation source, and configuration files.

“Object” form shall mean any form resulting from mechanical transformation or translation of a Source form, including but not limited to compiled object code, generated documentation, and conversions to other media types.

“Work” shall mean the work of authorship, whether in Source or Object form, made available under the License, as indicated by a copyright notice that is included in or attached to the work (an example is provided in the Appendix below).

“Derivative Works” shall mean any work, whether in Source or Object form, that is based on (or derived from) the Work and for which the editorial revisions, annotations, elaborations, or other modifications represent, as a whole, an original work of authorship. For the purposes of this License, Derivative Works shall not include works that remain separable from, or merely link (or bind by name) to the interfaces of, the Work and Derivative Works thereof.

“Contribution” shall mean any work of authorship, including the original version of the Work and any modifications or additions to that Work or Derivative Works thereof, that is intentionally submitted to Licensor for inclusion in the Work by the copyright owner or by an individual or Legal Entity authorized to submit on behalf of the copyright owner. For the purposes of this definition, “submitted” means any form of electronic, verbal, or written communication sent to the Licensor or its representatives, including but not limited to communication on electronic mailing lists, source code control systems, and issue tracking systems that are managed by, or on behalf of, the Licensor for the purpose of discussing and improving the Work, but excluding communication that is conspicuously marked or otherwise designated in writing by the copyright owner as “Not a Contribution.”

“Contributor” shall mean Licensor and any individual or Legal Entity on behalf of whom a Contribution has been received by Licensor and subsequently incorporated within the Work.

2. Grant of Copyright License. Subject to the terms and conditions of this License, each Contributor hereby grants to You a perpetual, worldwide, non-exclusive, no-charge, royalty-free, irrevocable copyright license to reproduce, prepare Derivative Works of, publicly display, publicly perform, sublicense, and distribute the Work and such Derivative Works in Source or Object form.
3. Grant of Patent License. Subject to the terms and conditions of this License, each Contributor hereby grants to You a perpetual, worldwide, non-exclusive, no-charge, royalty-free, irrevocable (except as stated in this section) patent license to make, have made, use, offer to sell, sell, import, and otherwise transfer the Work, where such license applies only to those patent claims licensable by such Contributor that are necessarily infringed by their Contribution(s) alone or by combination of their Contribution(s) with the Work to which such Contribution(s) was submitted. If You institute patent litigation against any entity (including a cross-claim or counterclaim in a lawsuit) alleging that the Work or a Contribution incorporated within the Work constitutes direct or contributory patent infringement, then any patent licenses granted to You under this License for that Work shall terminate as of the date such litigation is filed.
4. Redistribution. You may reproduce and distribute copies of the Work or Derivative Works thereof in any medium, with or without modifications, and in Source or Object form, provided that You meet the following conditions:
 - a. You must give any other recipients of the Work or Derivative Works a copy of this License; and
 - b. You must cause any modified files to carry prominent notices stating that You changed the files; and
 - c. You must retain, in the Source form of any Derivative Works that You distribute, all copyright, patent, trademark, and attribution notices from the Source form of the Work, excluding those notices that do not pertain to any part of the Derivative Works; and

d. If the Work includes a “NOTICE” text file as part of its distribution, then any Derivative Works that You distribute must include a readable copy of the attribution notices contained within such NOTICE file, excluding those notices that do not pertain to any part of the Derivative Works, in at least one of the following places: within a NOTICE text file distributed as part of the Derivative Works; within the Source form or documentation, if provided along with the Derivative Works; or, within a display generated by the Derivative Works, if and wherever such third-party notices normally appear. The contents of the NOTICE file are for informational purposes only and do not modify the License. You may add Your own attribution notices within Derivative Works that You distribute, alongside or as an addendum to the NOTICE text from the Work, provided that such additional attribution notices cannot be construed as modifying the License.

You may add Your own copyright statement to Your modifications and may provide additional or different license terms and conditions for use, reproduction, or distribution of Your modifications, or for any such Derivative Works as a whole, provided Your use, reproduction, and distribution of the Work otherwise complies with the conditions stated in this License.

5. Submission of Contributions. Unless You explicitly state otherwise, any Contribution intentionally submitted for inclusion in the Work by You to the Licensor shall be under the terms and conditions of this License, without any additional terms or conditions. Notwithstanding the above, nothing herein shall supersede or modify the terms of any separate license agreement you may have executed with Licensor regarding such Contributions.
6. Trademarks. This License does not grant permission to use the trade names, trademarks, service marks, or product names of the Licensor, except as required for reasonable and customary use in describing the origin of the Work and reproducing the content of the NOTICE file.
7. Disclaimer of Warranty. Unless required by applicable law or agreed to in writing, Licensor provides the Work (and each Contributor provides its Contributions) on an “AS IS” BASIS, WITHOUT WARRANTIES OR CONDITIONS OF ANY KIND, either express or implied, including, without limitation, any warranties or conditions of TITLE, NON-INFRINGEMENT, MERCHANTABILITY, or FITNESS FOR A PARTICULAR PURPOSE. You are solely responsible for determining the appropriateness of using or redistributing the Work and assume any risks associated with Your exercise of permissions under this License.
8. Limitation of Liability. In no event and under no legal theory, whether in tort (including negligence), contract, or otherwise, unless required by applicable law (such as deliberate and grossly negligent acts) or agreed to in writing, shall any Contributor be liable to You for damages, including any direct, indirect, special, incidental, or consequential damages of any character arising as a result of this License or out of the use or inability to use the Work (including but not limited to damages for loss of goodwill, work stoppage, computer failure or malfunction, or any and all other commercial damages or losses), even if such Contributor has been advised of the possibility of such damages.
9. Accepting Warranty or Additional Liability. While redistributing the Work or Derivative Works thereof, You may choose to offer, and charge a fee for, acceptance of support, warranty, indemnity, or other liability obligations and/or rights consistent with this License. However, in accepting such obligations, You may act only on Your own behalf and on Your sole responsibility, not on behalf of any other Contributor, and only if You agree to indemnify, defend, and hold each Contributor harmless for any liability incurred by, or claims asserted against, such Contributor by reason of your accepting any such warranty or additional liability.

END OF TERMS AND CONDITIONS

©2022 Bose Corporation

Licensed under the Apache License, Version 2.0 (the “License”); you may not use this file except in compliance with the License.

You may obtain a copy of the License at: <http://www.apache.org/licenses/LICENSE-2.0>

Unless required by applicable law or agreed to in writing, software distributed under the License is distributed on an “AS IS” BASIS, WITHOUT WARRANTIES OR CONDITIONS OF ANY KIND, either express or implied.

See the License for the specific language governing permissions and limitations under the License.

INNHALDET I ESKEN

Innhold	13
---------------	----

BOSE MUSIC-APP

Laste ned Bose Music-appen	14
Legge til hodetelefonene i en eksisterende konto	14

HODETELEFONKONTROLLER

Slå på	16
Timer for ventemodus	16
Slå av	17
Hodetelefonfunksjoner	18
Medieavspilling og volum	18
Telefonsamtaler	19
Handlingsknapp	20

STØYREDUKSJON

Moduser for støyreduksjon	21
Endre modusen for støyreduksjon	21

TALEKONTROLL

Aktivere stemmestyring	22
------------------------------	----

BLUETOOTH®-TILKOBLINGER

Koble til med <i>Bluetooth</i> -funksjonen på mobilenheten	23
Koble fra mobilenheter	25
Koble til mobilenheter på nytt	25
Koble til en annen mobilenhet	25
Identifisere tilkoblede mobilenheter	25
Bytte mellom to tilkoblede mobilenheter	25
Koble til tidligere tilkoblede enheter	26
Slette enhetslisten på hodetelefonene	26

KABLEDE TILKOBLINGER

Koble til lyd-kabelen.....	27
----------------------------	----

BATTERI

Lade hodetelefonene	28
Ladetid.....	28
Høre batterinivået.....	28

HODETELEFONENES STATUS

<i>Bluetooth</i> -status	29
Batteristatus	29
Ladestatus	30
Status for oppdatering og feil	30

KOBLE TIL BOSE-PRODUKTER

Koble til Bose Smart Speaker eller Soundbar	31
Fordeler	31
Kompatible produkter.....	31
Koble til med Bose Music-appen.....	31
Koble til en Bose Smart Speaker eller Soundbar på nytt.....	32

STELL OG VEDLIKEHOLD

Oppbevare hodetelefonene.....	33
Rengjøre hodetelefonene	34
Reservedeler og tilbehør	34
Begrenset garanti	34
Plassering av serienummer	35

FEILSØKING

Prøv dette først.....	36
Andre løsninger	36
Gjenopprette fabrikkinnstillingene på hodetelefonene	39

INNHOLD

Kontroller at følgende deler følger med:



Bose QuietComfort 45 headphones

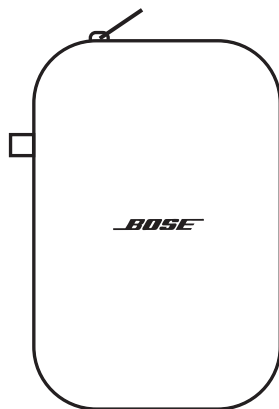

Myk bæreveske



USB Type-C®-kabel

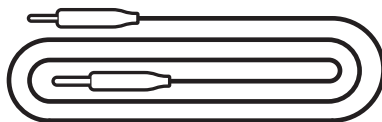

3,5 mm til 2,5 mm lyd kabel

MERKNAD: Ikke bruk produktet hvis deler av det er skadet. Kontakt en autorisert Bose-forhandler eller ring til kundestøtte for Bose.

Gå til support.bose.com/QCSE

Med Bose Music-appen kan du konfigurere og styre hodetelefonene fra en mobilenhet, for eksempel en smarttelefon eller et nettbrett.

Ved hjelp av appen kan du administrere *Bluetooth*-tilkoblinger, administrere innstillingene for hodetelefonene, velge språk for talemeldinger og få tilgang til nye funksjoner gjennom oppdateringer.

MERKNAD: Hvis du allerede har opprettet en Bose Music-konto for et annet Bose-produkt, kan du legge til hodetelefonene i den eksisterende kontoen (se nederst på side 14).

LASTE NED BOSE MUSIC-APPEN

1. Last ned Bose Music-appen på mobilenheten.

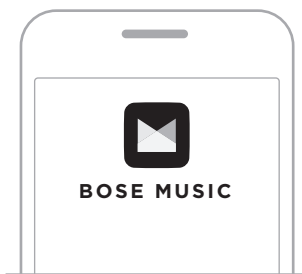

2. Følg instruksjonene i appen.

LEGG TIL HODETELEFONENE I EN EKSISTERENDE KUNTO

Åpne Bose Music-appen og legg til hodetelefonene for å legge til Bose QuietComfort 45-hodetelefonene.

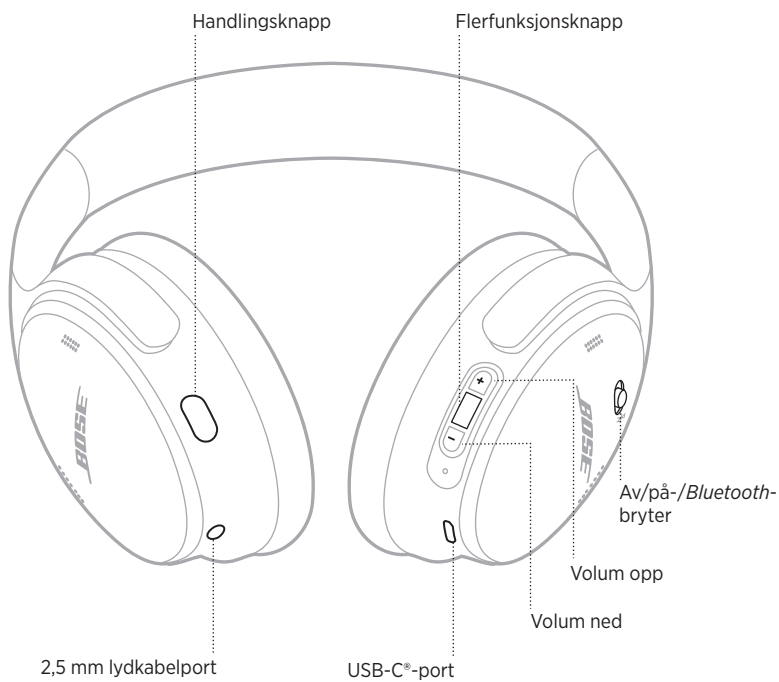

SLÅ PÅ

Skyv på/av-/Bluetooth-bryteren på høyre øreklokke mot høyre.

En talemelding angir batterinivået, og statuslampen lyser i henhold til gjeldende ladenivå (se side 29).



Timer for ventemodus

Timeren for ventemodus sparer batteriet når hodetelefonene ikke brukes.

Bruk Bose Music-appen til å konfigurere og tilpasse timeren for ventemodus.

SLÅ AV

Skyv på/av-/Bluetooth-bryteren mot venstre.



MERKNAD: Når hodetelefonene er slått av, er støyreduksjonen aktivert.

HODETELEFONFUNKSJONER

Hodetelefonkontrollene er plassert på baksiden av høyre øreklokke.

Medieavspilling og volum

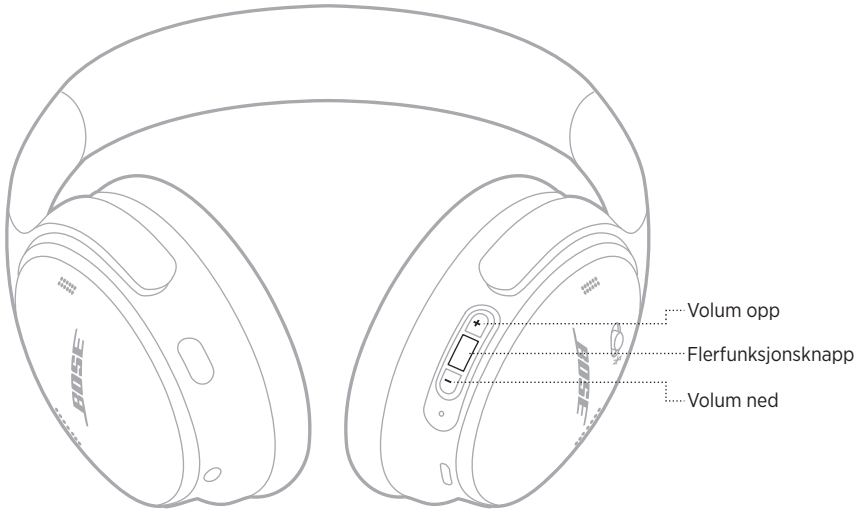

FUNKSJON	GJØR DETTE
Spill av / pause	Trykk på flerfunksjonsknappen.
Hopp fremover	Dobbeltrykk på flerfunksjonsknappen.
Hopp tilbake	Trippeltrykk på flerfunksjonsknappen.
Volum opp	Trykk på +.
Volum ned	Trykk på —.

MERKNADER:

- Hvis du vil øke volumet hurtig, trykker du på og holder +.
- Hvis du vil redusere volumet hurtig, trykker du på og holder —.

Telefonsamtaler

Flerfunksjonsknappen er plassert på baksiden av høyre øreklokke. Mikrofonen er plassert nær fronten av høyre øreklokke.

Handlingsknappen er plassert på baksiden av venstre øreklokke.

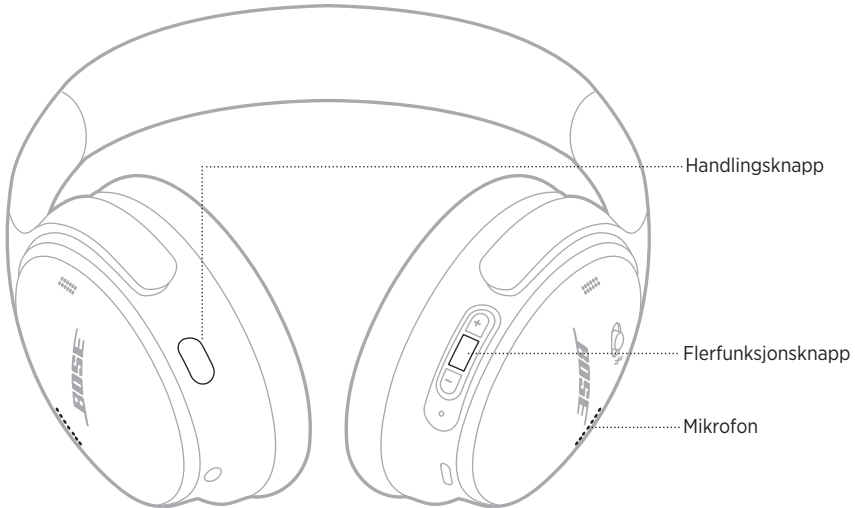

FUNKSJON	GJØR DETTE
Svare på og avslutte et anrop	Trykk på flerfunksjonsknappen.
Avvise en innkommende samtale	Trykk på og hold flerfunksjonsknappen i ett sekund.
Besvare en annen innkommende samtale og sette den aktive samtalen på vent	Når du er i en samtale og du får et innkommende anrop, trykker du på flerfunksjonsknappen.
Avvise en annen innkommende samtale og forbli i gjeldende samtale	Når du er i en samtale og du får et innkommende anrop, trykker du på og holder flerfunksjonsknappen i ett sekund.
Bytte mellom to samtaler	Når du har to aktive samtaler, dobbeltrykker du på flerfunksjonsknappen.
Opprette en konferansesamtale	Når to samtaler er aktive, trykker du på og holder flerfunksjonsknappen i tre sekunder.
Dempe / oppheve demping av en samtale	Dobbeltrykk på handlingsknappen mens du er i en samtale.

Handlingsknapp

Med handlingsknappen kan du raskt og enkelt bytte mellom modusene for støyreduksjon.

Handlingsknappen er plassert på baksiden av venstre øreklokke.



Trykk på handlingsknappen for å bytte mellom stillemodus og oppmerksomhetsmodus.

Du finner mer informasjon om de ulike modusene for støyreduksjon på side 21.

Støyreduksjon reduserer uønsket støy slik at du får klarere og mer livaktig lyd. Du kan velge mellom to moduser for støyreduksjon: Stille og Oppmerksom.

I stillemodus kan du blokkere distraksjoner med det høyeste nivået av støyreduksjon.

Oppmerksomhetsmodus gir full gjennomsiktighet slik at du kan høre omgivelsene samtidig som du hører på lyden din.

Velg støyreduksjonsmodus basert på hvordan du foretrekker å lytte og omgivelsene.

MODUSER FOR STØYREDUKSJON

MODUS	BESKRIVELSE
Stille	Støyreduksjon i verdensklasse med Bose-optimalisert lyd.
Oppmerksom	Hør omgivelsene samtidig som du hører på lyden din.

MERKNAD: Når hodetelefonene slås på, bruker de som standard den siste modusen du brukte.

ENDRE MODUSEN FOR STØYREDUKSJON

Trykk på handlingsknappen for å endre modus for støyreduksjon.

En talemelding informerer om valgt modus for støyreduksjon.

TIPS: Du kan også endre modusen for støyreduksjon med Bose Music-appen.

AKTIVERE STEMMESTYRING

Du kan bruke hodetelefonene til å få tilgang til stemmestyring på mobilenheten. Trykk på og hold flerfunksjonsknappen i ett sekund for å få tilgang til stemmestyring.

Flerfunksjonsknappen er plassert på baksiden av høyre øreklokke.

MERKNAD: Du har ikke tilgang til stemmestyring når du er i en samtale.

KOBLE TIL MED **BLUETOOTH**-FUNKSJONEN PÅ MOBILENHETEN

Du kan lagre opptil åtte enheter i listen over enheter på hodetelefonene, og hodetelefonene kan kobles aktivt til to enheter om gangen. Du kan bare spille av lyd fra én enhet om gangen.

MERKNAD: Den beste opplevelsen får du ved å bruke Bose Music-appen til å sette opp og koble til mobilenheten (se side 14).

1. Skyv på/av-/*Bluetooth*-knappen mot høyre ⤴ og hold den der i tre sekunder.

Du hører «Ready to connect» (Klar til å koble til), og statuslampen blinker blått.



2. Aktiver *Bluetooth*-funksjonen på enheten.

MERKNAD: *Bluetooth*-funksjonen er vanligvis i Innstillinger-menyen.

3. Velg hodetelefonene fra enhetslisten.

TIPS: Se etter navnet du ga hodetelefonene i Bose Music-appen. Standardnavnet vises hvis du ikke har gitt hodetelefonene navn.



Når de er koblet til, hører du «Connected to <navnet på mobilenheten>» (Koblet til <navnet på mobilenheten>) og statuslampen lyser blått i 10 sekunder.

KOBLE FRA MOBILENHETER

Bruk Bose Music-appen til å koble fra mobilenheten.

TIPS: Du kan også koble fra produktet ved hjelp av *Bluetooth*-innstillingene. Når du deaktiverer *Bluetooth*, kobles samtidig alle andre enheter fra.

KOBLE TIL MOBILENHETER PÅ NYTT

Når hodetelefonene slås på, prøver de å koble til de to sist tilkoblede enhetene.

MERKNADER:

- Enheten må være innenfor rekkevidde (9 m eller 30 fot) og slått på.
- Sjekk at *Bluetooth*-funksjonen er aktivert på mobilenheten.

KOBLE TIL EN ANNEN MOBILENHET

Hvis du vil koble til enda en enhet, laster du ned Bose Music-appen (se side 14) eller bruker *Bluetooth*-menyen på mobilenheten (se side 23).

MERKNAD: Du kan bare spille av lyd fra én enhet om gangen.

IDENTIFISERE TILKOBLEDE MOBILENHETER

Skyv på/av-/*Bluetooth*-bryteren mot høyre ⌘ og slipp den for å høre hvilken enhet som er koblet til.

BYTTE MELLOM TO TILKOBLEDE MOBILENHETER

1. Stopp avspillingen av lyd på den første mobilenheten midlertidig.
2. Spill av lyd på den andre mobilenheten.

MERKNAD: Hodetelefonene mottar telefonsamtaler fra begge enheter, uansett hvilken enhet som spiller av lyd.

KOBLE TIL TIDLIGERE TILKOBLEDE ENHETER

1. Skyv på/av-/*Bluetooth*-bryteren mot høyre ☞ og slipp den for å høre hvilken enhet som er koblet til.
2. Skyv på/av-/*Bluetooth*-brytere mot høyre innen to sekunder ☞, og slipp for å koble til neste enhet i enhetslisten for hodetelefonene.
3. Gjenta til du hører riktig enhetsnavn.
Du vil høre en tone som indikerer at enheten er koblet til.
4. Spill av lyd på den tilkoblede mobilenheten.

MERKNAD: Hvis to enheter allerede er koblet til hodetelefonen, erstatter den nylig tilkoblede enheten den andre enheten som var koblet til fra før.

SLETTE ENHETSLISTEN PÅ HODETELEFONENE

1. Skyv på/av-/*Bluetooth*-bryteren mot høyre ☞ og hold den der i 15 sekunder til du hører «*Bluetooth* device list cleared. Ready to connect.» (*Bluetooth*-enhetslisten er slettet. Klar til å koble til.)
2. Slett hodetelefonene fra *Bluetooth*-listen på mobilenheten.
Alle enheter fjernes, og hodetelefonene er klare til sammenkobling.

KOBLE TIL LYDKABELEN

Bruk 2,5 mm til 3,5 mm-kabelen til å koble til enheter som ikke er trådløse eller for å fortsette å bruke hodetelefonene hvis batteriet er utladet.

1. Koble kabelen til 2,5 mm-porten på venstre øreklokke.



2. Koble den andre enden av kabelen til 3,5 mm-porten på enheten.

MERKNAD: Du kan bruke hodetelefonene både påslått og avslått når lyd-kabelen er koblet til.

LADE HODETELEFONENE

1. Stikk den lille pluggen på USB-kabelen inn i USB C-porten på høyre øreklokke.
2. Koble den andre enden til en USB-vegglader.



MERKNADER:

- Når ladingen av hodetelefonene starter, blinker statuslampen hvitt i 10 sekunder. Statuslampen lyser hvitt når de er fulladet.
- Hodetelefonene kan ikke brukes til lytting under lading.

Ladetid

Det kan ta 2,5 time å lade hodetelefonene helt.

Høre batterinivået

Hver gang du slår hodetelefonene på, vil en talemelding angi batterinivået. Når batterinivået i hodetelefonene er lavt, hører du «Battery low, please charge now» (Lavt batterinivå, lad nå).

MERKNAD: Du kan kontrollere batterinivået visuelt ved å se på statuslampen som er plassert på høyre øreklokke. Hvis du vil ha mer informasjon, kan du se «Batteristatus» på side 29.

Statuslampen er plassert på høyre øreklokke.



BLUETOOTH-STATUS

Viser statusen for *Bluetooth*-tilkoblingen.

LAMPEAKTIVITET	SYSTEMSTATUS
Blinker blått	Klar for tilkobling
Lyser blått (10 sekunder)	Tilkoblet

BATTERISTATUS

Viser batterinivået.

LYSAKTIVITET	SYSTEMSTATUS
Lyser hvitt	Middels eller fullstendig oppladet
Lyser gult	Lite batteristrøm

TIPS: Du kan også kontrollere batterinivået med Bose Music-appen.

LADESTATUS

Viser ladestatusen.

LYSAKTIVITET	SYSTEMSTATUS
Blinker hvitt to ganger	Ladingen starter
Lyser gult	Lader
Lyser hvitt	Fulladet

STATUS FOR OPPDATERING OG FEIL

Viser status for oppdatering og feil.

LYSAKTIVITET	SYSTEMSTATUS
Blinker raskt hvitt (10 sekunder)	Oppdaterer programvare (via USB)
Blinker langsomt hvitt (30 til 60 sekunder)	Oppdaterer programvare (trådløst)
Blinker gult og hvitt	Feil - kontakt kundestøtte hos Bose

KOBLE TIL BOSE SMART SPEAKER ELLER SOUNDBAR

Med Bose SimpleSync™-teknologi kan du koble hodetelefonene til en Bose Smart Soundbar eller en Bose Smart Speaker for å få en personlig lytteopplevelse.

Fordeler

- Bruk uavhengige volumkontroller på hvert produkt til å senke eller dempe lyden på Bose Smart Soundbar samtidig som du har så høy lyd som du ønsker i hodetelefonene.
- Hør musikken tydelig fra rommet ved siden av ved å koble hodetelefonene til Bose Smart Speaker.

MERKNAD: SimpleSync™-teknologien har en *Bluetooth*-rekkevidde på opptil ni meter. Vegger og byggematerialer kan påvirke mottaket.

Kompatible produkter

Du kan koble hodetelefonene til alle typer Bose Smart Speaker og Bose Smart Soundbar.

Populære compatible produkter er:

- Bose Smart Soundbar 700 / Bose Soundbar 700
- Bose Soundbar 500
- Bose Smart Speaker 500 / Bose Home Speaker 500
- Bose Home Speaker 300
- Bose Portable Smart Speaker / Bose Portable Home Speaker

Nye produkter legges til regelmessig. Her finner du en fullstendig liste og mer informasjon: worldwide.Bose.com/Support/Groups

Koble til med Bose Music-appen

1. Skyv på/av-/*Bluetooth*-knappen på hodetelefonene mot høyre ⌘ og hold den der i tre sekunder.

Du hører «Ready to connect another device» (klar til å koble til en ny enhet), og statuslampen blinker blått.

2. Bruk Bose Music-appen til å koble hodetelefonene til et kompatibelt Bose-produkt. Hvis du vil ha mer informasjon, kan du gå til worldwide.Bose.com/Support/Groups

MERKNADER:

- Påse at hodetelefonene er innenfor 9 m fra lydplanken eller høyttaleren.
- Du kan bare koble høyttalerne til ett produkt om gangen.

KOBLE TIL EN BOSE SMART SPEAKER ELLER SOUNDBAR PÅ NYTT

Slå på hodetelefonene på (se “Slå på” på side 16).

Hodetelefonene forsøker å koble til de to sist tilkoblede *Bluetooth*-enhetene, inkludert lydplanken eller høyttaleren.

MERKNADER:

- Lydplanken eller høyttaleren må være innenfor rekkevidde (9 m) og slått på.
- Hvis hodetelefonene ikke kobles til, kan du se “Hodetelefonene kobles ikke til en tidligere tilkoblet Bose Smart Soundbar eller Speaker” på side 38.

OPPBEVARE HODETELEFONENE

Øreklokkene kan vris for enkel og praktisk oppbevaring. Plasser hodetelefonene flatt i esken.

1. Vri begge øreklokkene innover, slik at de ligger flatt.



2. Brett den venstre øreklokken opp mot hodebøylen.

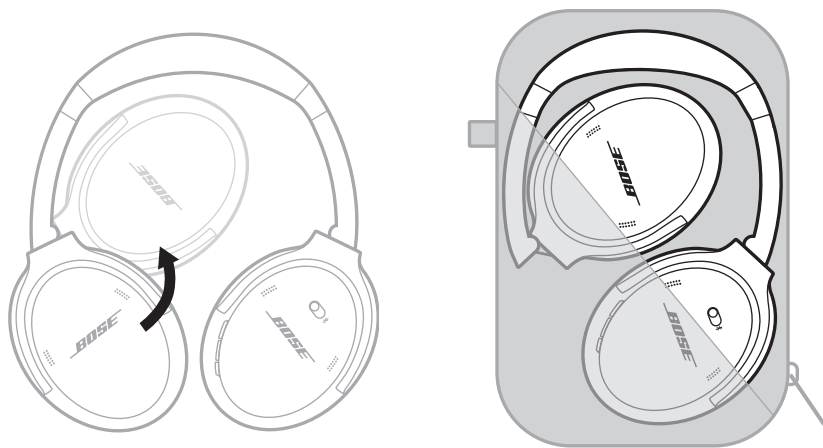

MERKNADER:

- Pass på å slå hodetelefonene av når de ikke er i bruk.
- Påse at batteriet er fulladet hvis du skal oppbevare hodetelefonene avslått i mer enn noen få måneder.

RENGJØRE HODETELEFONENE

Tørk av overflatene på utsiden med en myk, tørr klut.

Ikke la det komme fuktighet inn i øreklokkene.

RESERVEDELER OG TILBEHØR

Reservedeler og tilbehør kan bestilles fra kundestøtte hos Bose. Gå til support.Bose.com/QCSE

BEGRENSET GARANTI

Hodetelefonene dine er dekket av en begrenset garanti. Detaljert informasjon om den begrensede garantien finnes på nettstedet worldwide.Bose.com/Warranty.

Du finner instruksjoner for hvordan du registrerer produktet her: worldwide.Bose.com/ProductRegistration. Hvis du ikke registrerer produktet, påvirker det ikke rettighetene dine i henhold til den begrensede garantien.

PLASSERING AV SERIENUMMER

Serienummeret er plassert på innsiden av høyre øreklokke under polstringen. Polstringen er den innerste delen som dekker og beskytter komponentene i øreklokken.

Hvis du vil se serienummeret, tar du tak i dekslet i øverste kant og fjerner det forsiktig.

FORSIKTIG: Vær forsiktig så du ikke trykker inn eller drar ut noen andre komponenter i øreklokken, siden det kan skade hodetelefonene.

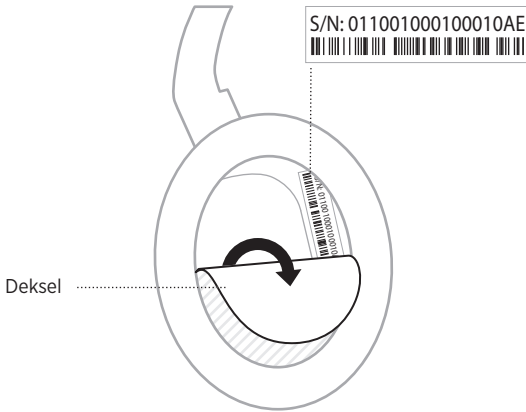

PRØV DETTE FØRST

Hvis det oppstår problemer med hodetelefonene:

- Kontroller tilstanden til statuslampene (se side 29).
- Lad batteriet (se side 28).
- Øk volumet på hodetelefonene, på mobilenheten og i musikkappen.
- Last ned Bose Music-appen, og kjør tilgjengelige programvareoppdateringer (se side 14).
- Prøv å koble til en annen mobilenhet (se side 25).

Hvis du ikke kan løse problemet, kan tabellen nedenfor være til hjelp for å identifisere symptomer og løsninger på vanlige problemer. Kontakt kundestøtte hos Bose hvis du ikke greier å løse problemet.

Gå til worldwide.Bose.com/contact

ANDRE LØSNINGER

PROBLEM	LØSNING
Hodetelefonene slår seg ikke på	Lad batteriet.
Hodetelefonene kobler ikke til mobilenheten	<p>Koble fra reservelydkabelen.</p> <p>Koble fra USB-ladekabelen.</p> <p>På den mobile enheten:</p> <p>Deaktiver og aktiver <i>Bluetooth</i>-funksjonen på enheten.</p> <p>Slett Bose QuietComfort 45-hodetelefonene fra <i>Bluetooth</i>-listen på enheten, inkludert eventuelle duplikatoppføringer merket LE (Low Energy). Koble til på nytt.</p> <p>Flytt mobilenheten nærmere hodetelefonene og bort fra eventuelle forstyrrelser eller hindringer.</p> <p>Gå til support.Bose.com/QCSE for å se instruksjonsvideoer.</p> <p>Nullstill listen over tilkoblede enheter (se side 26) og koble til på nytt.</p>
Batteriet lades ikke	<p>Kontroller at endene av USB-kabelen er godt festet.</p> <p>Prøv en annen ladekilde.</p> <p>Hvis hodetelefonene har vært utsatt for høye eller lave temperaturer, må du la dem få romtemperatur før du prøver å lade på nytt.</p>

PROBLEM	LØSNING
Ingen lyd	<p>Slå hodetelefonene på og lad batteriet.</p> <p>Kontroller tilstanden til statuslampene (se side 29).</p> <p>Skyv på/av-/Bluetooth-bryteren mot høyre og slipp for å høre hvilken enhet som er tilkoblet. Kontroller at du bruker riktig enhet.</p> <p>Flytt mobilenheten nærmere hodetelefonene og bort fra eventuelle forstyrrelser eller hindringer.</p> <p>Bruk en annen musikkilde.</p> <p>Hvis det er koblet til to enheter, må du først stoppe avspillingen midlertidig på den andre mobile enheten.</p> <p>Hvis det er koblet til to mobilenheter, flytter du enhetene innen rekkevidde for hodetelefonene (9 m eller 30 fot).</p> <p>Prøv en musikk- eller videofil som er lagret lokalt på mobilenheten.</p>
Dårlig lyd kvalitet	<p>Bruk en annen musikkilde.</p> <p>Koble til en annen mobilenhet (se side 25).</p> <p>Koble fra den andre enheten.</p> <p>Flytt mobilenheten nærmere hodetelefonene og bort fra eventuelle forstyrrelser eller hindringer.</p> <p>Prøv en musikk- eller videofil som er lagret lokalt på mobilenheten.</p>
Ingen lyd fra en enhet som er koblet til ved hjelp av reservelydkabelen	<p>Kontroller at endene av reservelydkabelen er godt festet.</p> <p>Øk volumet på hodetelefonene, på mobilenheten og på musikkilden.</p> <p>Koble til en annen enhet (se side 25).</p>
Dårlig lyd kvalitet fra enheten som er koblet til med lyd kabelen	<p>Kontroller at endene av reservelydkabelen er godt festet.</p> <p>Koble til en annen enhet (se side 25).</p>
Handlingsknappen endrer ikke modusen for støyreduksjon	<p>Kontroller at hodetelefonene er slått på.</p> <p>Bruk Bose Music-appen til å endre modus for støyreduksjon.</p>

PROBLEM	LØSNING
Hodetelefonene kobler seg ikke til en Bose Smart Soundbar eller Speaker	<p>Skv og hold på/av-/<i>Bluetooth</i>-knappen til du hører «Ready to connect another device» (Klar til å koble til en annen enhet) og <i>Bluetooth</i>-lampen blinker blått.</p> <p>Påse at hodetelefonene er innenfor 9 m fra lydplanken eller høyttaleren.</p>
Hodetelefonene kobles ikke til en tidligere tilkoblet Bose Smart Soundbar eller Speaker	<p>Koble til en tidligere tilkoblet enhet på nytt (se side 26).</p>
Forsinket lyd når koblet til en Bose Smart Soundbar eller Speaker	<p>Last ned Bose Music-appen, og kjør tilgjengelige programvareoppdateringer.</p>

En gjenoppretting til fabrikkinnstillingene kan nullstille alle innstillinger og sette hodetelefonene tilbake til den opprinnelige tilstanden. Etter det kan hodetelefonene konfigureres som om de ble konfigurert for første gang.

Gjenoppretting til fabrikkinnstillingene anbefales bare hvis du har problemer med hodetelefonene, eller hvis du har fått beskjed om det fra kundeservice hos Bose.

GJENOPPRETTE FABRIKKINNSTILLINGENE PÅ HODETELEFONENE

1. Fjern hodetelefonene fra *Bluetooth*-listen på enheten.
2. Fjern hodetelefonene fra Bose-kontoen med Bose Music-appen.

MERKNAD: Du finner mer informasjon om hvordan du fjerner hodetelefonene fra Bose-kontoen med Bose Music-appen her: support.bose.com/QCSE

3. Skyv på/av-/*Bluetooth*-knappen mot høyre ⌘ og hold. Samtidig trykker du på og holder handlingsknappen i 30 sekunder.

Statuslampen blinker hvitt. Etter 30 sekunder blinker statuslampen gult for å angi at fabrikkinnstillinger blir gjenopprettet (to til tre sekunder).

4. Når gjenopprettingen er fullført, blinker statuslampen langsomt blått. Hodetelefonene er nå i opprinnelig tilstand slik de ble sendt fra fabrikk.

Należy przeczytać i zachować wszystkie zalecenia dotyczące bezpieczeństwa, zabezpieczeń i korzystania z tego produktu.

CE Firma Bose Corporation niniejszym deklaruje, że ten produkt jest zgodny z podstawowymi wymaganiami i zaleceniami określonymi w dyrektywie 2014/53/UE oraz innych obowiązujących dyrektywach UE. Deklaracja zgodności jest dostępna w następującej witrynie internetowej: www.Bose.com/compliance

UK CA Ten produkt jest zgodny ze wszystkimi obowiązującymi wymaganiami dokumentu Electromagnetic Compatibility Regulations 2016 oraz wszelkimi innymi przepisami obowiązującymi w Wielkiej Brytanii. Deklaracja zgodności jest dostępna w następującej witrynie internetowej: www.Bose.com/compliance

Firma Bose Corporation niniejszym deklaruje, że ten produkt jest zgodny z podstawowymi wymaganiami i zaleceniami określonymi w dokumencie Radio Equipment Regulations 2017 oraz wszelkich innych przepisach obowiązujących w Wielkiej Brytanii. Deklaracja zgodności jest dostępna w następującej witrynie internetowej: www.Bose.com/compliance

Ważne zalecenia dotyczące bezpieczeństwa

Nie korzystaj z tego urządzenia w pobliżu wody.

Czyść urządzenie wyłącznie suchą ściereczką.

Wykonanie wszystkich prac serwisowych należy zlecić wykwalifikowanemu personelowi. Wykonanie prac serwisowych jest konieczne w przypadku uszkodzenia urządzenia, na przykład w następujących okolicznościach: uszkodzenie przewodu zasilającego lub wtyczki, przedostanie się cieczy lub przedmiotów do wnętrza urządzenia, narażenie urządzenia na oddziaływanie deszczu lub wilgoci, nieprawidłowe funkcjonowanie lub upadek urządzenia.

OSTRZEŻENIA/PRZESTROGI

- NIE wolno korzystać ze słuchawek przy wysokim poziomie głośności przez dłuższy czas.
 - Aby zapobiec uszkodzeniu słuchu, należy korzystać ze słuchawek przy komfortowym, średnim poziomie głośności.
 - Przed założeniem słuchawek należy zmniejszyć głośność, a następnie stopniowo zwiększać ją do poziomu umożliwiającego komfortowe słuchanie.
- NIE wolno korzystać ze słuchawek podczas prowadzenia pojazdów. Dotyczy to zarówno rozmów telefonicznych, jak i innych zastosowań.
- NIE wolno korzystać ze słuchawek w trybie redukcji szumów wówczas, gdy brak możliwości usłyszenia dźwięków w otoczeniu może stwarzać zagrożenie dla użytkownika lub innych osób, na przykład podczas jazdy na rowerze, poruszania się w miejscach o dużym natężeniu ruchu drogowego, w pobliżu placu budowy lub torów kolejowych. Należy przestrzegać obowiązujących przepisów dotyczących korzystania ze słuchawek.
 - Aby mieć pewność, że dźwięki otoczenia, w tym alarmy i sygnały ostrzegawcze, będą słyszalne, należy zdjąć słuchawki lub korzystać ze słuchawek z wyłączonym trybem redukcji szumów i dostosować poziom głośności.
 - Należy pamiętać, że słuchawki powodują zmianę brzmienia ważnych dźwięków, takich jak przypomnienia lub ostrzeżenia (nawet w trybie Brak).
- NIE wolno korzystać ze słuchawek, jeżeli emitują one głośny, nietypowy dźwięk. W takim wypadku należy wyłączyć słuchawki i skontaktować się z Działem Obsługi Klientów firmy Bose.
- W przypadku odczucia wzrostu temperatury lub braku dźwięku należy natychmiast zdjąć słuchawki.
- NIE wolno podłączać zestawu słuchawkowego do gniazda w fotelu w samolocie przy użyciu adapterów do telefonów komórkowych, ponieważ może to spowodować zranienie lub uszkodzenie na skutek przegrzania.
- NIE wolno używać słuchawek jako zestawu słuchawek lotniczych.



Produkt zawiera małe części, które mogą spowodować zadławienie. Nie jest on odpowiedni dla dzieci w wieku poniżej trzech lat.



Produkt zawiera elementy magnetyczne. Aby uzyskać informacje dotyczące wpływu tych elementów na funkcjonowanie implantów medycznych, należy skontaktować się z lekarzem.

- Aby ograniczyć ryzyko pożaru i porażenia prądem elektrycznym, NIE należy wystawiać urządzeń na działanie deszczu, kapania, rozbryzgów lub wilgoci, a także nie wolno umieszczać w jego pobliżu naczyń wypełnionych płynami, takich jak wazony.
- Należy zachować odpowiednią odległość urządzenia od ognia i źródeł ciepła. NIE umieszczaj źródeł otwartego ognia (np. zapalonych świec) na urządzeniu ani w jego pobliżu.
- Urządzenia należy używać wyłącznie z zasilaczem LPS atestowanym przez odpowiednią instytucję, zgodnie z lokalnymi przepisami (np. UL, CSA, VDE, CCC).
- NIE wolno modyfikować urządzenia bez zezwolenia.
- W przypadku wycieku cieczy z baterii nie wolno dopuścić do kontaktu tej cieczy ze skórą lub oczami. W przypadku kontaktu cieczy z baterii ze skórą lub oczami należy skorzystać z pomocy medycznej.
- Należy chronić produkty z bateriami przed zbyt wysokimi temperaturami (np. nie wolno przechowywać ich w miejscu narażonym na bezpośrednie światło słoneczne, ogień itp.).
- NIE wolno korzystać ze słuchawek podczas ładowania ich baterii.

UWAGA: Urządzenie zostało przetestowane i uznane za zgodne z wymaganiami dotyczącymi urządzeń cyfrowych klasy B, określonymi w części 15 przepisów komisji FCC. Te limity określono w celu zapewnienia uzasadnionej ochrony przed zakłóceniami w instalacjach budynków mieszkalnych. Urządzenie wytwarza i wykorzystuje energię promieniowania o częstotliwości radiowej i może powodować zakłócenia komunikacji radiowej, jeżeli nie jest zainstalowane i użytkowane zgodnie z zaleceniami producenta. Nie można zagwarantować, że działanie niektórych instalacji nie będzie zakłócać. Jeżeli urządzenie zakłóca odbiór radiowy lub telewizyjny, co można sprawdzić poprzez jego wyłączenie i ponownie włączenie, zakłócenia tego typu można eliminować, korzystając z następujących metod:

- Zmiana ustawienia lub lokalizacji produktu albo anteny odbiorczej.
- Zwiększenie odległości pomiędzy urządzeniem a odbiornikiem.
- Podłączenie urządzenia do gniazda sieci elektrycznej w innym obwodzie niż ten, do którego podłączony jest odbiornik.
- Skonsultowanie się z dystrybutorem lub doświadczonym technikiem radiowo-telewizyjnym w celu uzyskania pomocy technicznej.

Modyfikacje urządzenia, które nie zostały wyraźnie zatwierdzone przez firmę Bose Corporation, mogą spowodować anulowanie prawa użytkownika do korzystania z urządzenia.

To urządzenie jest zgodne z częścią 15 przepisów komisji FCC i standardami RSS organizacji ISED Canada dotyczącymi licencji. Zezwolenie na użytkowanie urządzenia jest uzależnione od spełnienia następujących dwóch warunków: (1) urządzenie nie może powodować szkodliwych zakłóceń i (2) musi być odporne na zakłócenia zewnętrzne, łącznie z zakłóceniami powodującymi nieprawidłowe funkcjonowanie.

To urządzenie jest zgodne z dopuszczalnymi wartościami granicznymi narażenia na promieniowanie, określonymi dla populacji ogólnej przez komisję FCC i organizację ISED Canada. Ten nadajnik nie powinien znajdować się w pobliżu innej anteny ani nadajnika i nie powinien działać w połączeniu z takimi urządzeniami.

Urządzenie spełnia wymagania IMDA.

FCC ID: A94437310

IC: 3232A-437310

CAN ICES-3(B)/NMB-3(B)

Europa:

Zakres częstotliwości roboczej urządzenia 2400–2483,5 MHz.

Maksymalna moc nadawcza poniżej 20 dBm EIRP.

Maksymalna moc nadawcza jest niższa niż limity ustawowe, dlatego test SAR nie jest konieczny i można uzyskać zwolnienie zgodnie z obowiązującymi przepisami.



Ten symbol oznacza, że produktu nie wolno utylizować razem z odpadami komunalnymi. Produkt należy dostarczyć do odpowiedniego miejsca zbiórki w celu recyklingu. Prawidłowa utylizacja i recykling ułatwiają ochronę zasobów naturalnych, ludzkiego zdrowia i środowiska naturalnego. Aby uzyskać więcej informacji dotyczących utylizacji i recyklingu tego produktu, należy skontaktować się z samorządem lokalnym, zakładem utylizacji odpadów lub sklepem, w którym produkt został zakupiony.

Rozporządzenia techniczne dotyczące urządzeń radiowych małej mocy

Bez zgody udzielonej przez komisję NCC żadna firma, przedsiębiorstwo ani użytkownik nie ma prawa zmieniać częstotliwości, zwiększać mocy nadawczej ani modyfikować oryginalnych parametrów oraz sposobu działania zatwierdzonych urządzeń radiowych małej mocy. Urządzenia radiowe małej mocy nie powinny wpływać na bezpieczeństwo lotnicze ani zakłócać komunikacji służbowej. W przypadku stwierdzenia zakłóceń użytkownik ma obowiązek natychmiast zaprzestać użytkowania urządzenia do momentu ustąpienia zakłóceń. Komunikacja służbowa oznacza komunikację radiową prowadzoną zgodnie z ustawą Prawo telekomunikacyjne. Urządzenia radiowe małej mocy ulegają zakłóceniom pochodzącym z komunikacji służbowej lub urządzeń promieniujących w radiowym pasmie ISM.

NIE wolno samodzielnie wyjmować akumulatorowej baterii litowo-jonowej z tego urządzenia. W celu wyjęcia tego elementu należy skontaktować się z lokalnym sprzedawcą produktów firmy Bose lub z wykwalifikowanym technikiem.

Akumulatorowa bateria litowo-jonowa zainstalowana w tym urządzeniu powinna być usuwana wyłącznie przez wykwalifikowanego technika. Więcej informacji można uzyskać od lokalnego sprzedawcy produktów firmy Bose lub na stronie internetowej products.bose.com/static/compliance/index.html.



RECZYSTOŚĆ

Zużyte baterie należy prawidłowo utylizować zgodnie z lokalnymi przepisami. Nie spalać.



Nazwy i zawartość toksycznych lub szkodliwych substancji albo pierwiastków						
Nazwa części	Toksyczne lub szkodliwe substancje albo pierwiastki					
	Ołów (Pb)	Rtęć (Hg)	Kadm (Cd)	Sześciowartościowy chrom (Cr(VI))	Polibromowany bifenyl (PBB)	Polibromowany difenyleter (PBDE)
Obwody drukowane (PCB)	X	0	0	0	0	0
Części metalowe	X	0	0	0	0	0
Części plastikowe	0	0	0	0	0	0
Głośnik	X	0	0	0	0	0
Przewody	X	0	0	0	0	0
Tę tabelę przygotowano zgodnie z wymaganiami normy SJ/T 11364.						
0: Oznacza, że dana substancja toksyczna lub szkodliwa, zawarta we wszystkich jednorodnych materiałach dla tej części, nie przekracza limitu określonego w normie GB/T 26572.						
X: Oznacza, że dana substancja toksyczna lub szkodliwa, zawarta w co najmniej jednym z jednorodnych materiałów użytych w tej części, przekracza limit określony w normie GB/T 26572.						

Data produkcji: Ósma cyfra numeru seryjnego oznacza rok produkcji, np. cyfra „2” oznacza rok 2012 lub 2022.

Importer — Chiny: Bose Electronics (Shanghai) Company Limited, Level 6, Tower D, No. 2337 Gudai Rd. Minhang District, Shanghai 201100

Importer — UE: Bose Products B.V., Gorslaan 60, 1441 RG Purmerend, The Netherlands

Importer — Meksyk: Bose de México S. de R.L. de C.V., Avenida Prado Sur #150, Piso 2, Interior 222 y 223, Colonia Lomas de Chapultepec V Sección, Miguel Hidalgo, Ciudad de México, C.P. 11000 Numer telefonu: +5255 (5202) 3545

Importer — Tajwan: Bose Limited Taiwan Branch (H.K.), 9F., No. 10, Sec. 3, Minsheng E. Road, Zhongshan Dist. Taipei City 10480, Taiwan Numer telefonu: +886-2-2514 7676

Importer — Wielka Brytania: Bose Limited, Bose House, Quayside Chatham Maritime, Chatham, Kent, ME4 4QZ, United Kingdom

Zasilanie: 5 V --- 0,5 A

Zakres temperatur otoczenia (ładowanie): od 0°C do 45°C

Zakres temperatur otoczenia (rozładowywanie): od -20°C do 60°C

Model 437310. Identyfikator CMIIT ID znajduje się wewnątrz muszli słuchawek pod siateczką.

Prosimy o wpisanie i zachowanie poniższych informacji

Numer seryjny i numer modelu znajdują się wewnątrz muszli słuchawek pod siateczką.

Numer seryjny: _____

Numer modelu: _____

Należy zachować dowód zakupu razem z podręcznikiem użytkownika. Warto teraz zarejestrować zakupiony produkt firmy Bose. Można to zrobić w łatwy sposób w witrynie internetowej worldwide.Bose.com/ProductRegistration

Informacje dotyczące zabezpieczeń

Ten produkt może automatycznie otrzymywać aktualizacje zabezpieczeń od firmy Bose po ustanowieniu połączenia z aplikacją Bose Music. Aby otrzymywać aktualizacje zabezpieczeń przy użyciu aplikacji mobilnej, należy skonfigurować produkt w aplikacji Bose Music. **Jeżeli ten proces konfiguracji nie zostanie przeprowadzony, użytkownik będzie zobowiązany do samodzielnego instalowania aktualizacji zabezpieczeń udostępnianych przez firmę Bose w witrynie internetowej btu.bose.com.**

Apple, logo Apple, iPad, iPhone oraz iPod są znakami towarowymi firmy Apple Inc. zarejestrowanymi w Stanach Zjednoczonych i w innych krajach. App Store jest znakiem usługowym firmy Apple Inc. Znak towarowy iPhone jest używany w Japonii na podstawie licencji firmy Aiphone K.K.

Znak „Made for Apple” oznacza, że dane akcesorium zostało zaprojektowane pod kątem współpracy z produktami firmy, które są na nim wyszczególnione, i poddane procesowi certyfikacji potwierdzającemu spełnienie standardów jakości firmy Apple. Firma Apple nie ponosi odpowiedzialności za działanie tego urządzenia ani jego zgodność z przepisami lub normami bezpieczeństwa.

Znak słowny i logo *Bluetooth*® są zastrzeżonymi znakami towarowymi firmy Bluetooth SIG, Inc., używanymi przez firmę Bose Corporation na podstawie licencji.

Google Play jest znakiem towarowym firmy Google LLC.

Nazwy USB Type-C® i USB-C® są zastrzeżonymi znakami towarowymi należącymi do organizacji USB Implementers Forum.

Bose, Bose Home Speaker, Bose Music, logo Bose Music, Bose Smart Soundbar, Bose Smart Speaker, Bose Soundbar, QuietComfort i SimpleSync są znakami towarowymi firmy Bose Corporation.

Siedziba główna firmy Bose Corporation: 1-877-230-5639

©2022 Bose Corporation. Żadnej części tej publikacji nie wolno powielać, modyfikować, rozpowszechniać ani wykorzystywać w inny sposób bez uprzedniego uzyskania pisemnego zezwolenia.

The following license disclosures apply to certain third-party software packages used as components in the product.

Package: FreeRTOS

Copyright © Amazon Web Services, Inc. or its affiliates. All rights reserved.

The FreeRTOS package is subject to the license terms reprinted below:

MIT License

Permission is hereby granted, free of charge, to any person obtaining a copy of this software and associated documentation files (the “Software”), to deal in the Software without restriction, including without limitation the rights to use, copy, modify, merge, publish, distribute, sublicense, and/or sell copies of the Software, and to permit persons to whom the Software is furnished to do so, subject to the following conditions:

The above copyright notice and this permission notice shall be included in all copies or substantial portions of the Software.

THE SOFTWARE IS PROVIDED “AS IS”, WITHOUT WARRANTY OF ANY KIND, EXPRESS OR IMPLIED, INCLUDING BUT NOT LIMITED TO THE WARRANTIES OF MERCHANTABILITY, FITNESS FOR A PARTICULAR PURPOSE AND NONINFRINGEMENT. IN NO EVENT SHALL THE AUTHORS OR COPYRIGHT HOLDERS BE LIABLE FOR ANY CLAIM, DAMAGES OR OTHER LIABILITY, WHETHER IN AN ACTION OF CONTRACT, TORT OR OTHERWISE, ARISING FROM, OUT OF OR IN CONNECTION WITH THE SOFTWARE OR THE USE OR OTHER DEALINGS IN THE SOFTWARE.

Package: Nanopb

Copyright © 2011 Petteri Aimonen <jpa at nanopb.mail.kapsi.fi>.

The Nanopb package is subject to the license terms reprinted below:

Zlib License

© 2011 Petteri Aimonen <jpa at nanopb.mail.kapsi.fi>

This software is provided ‘as-is’, without any express or implied warranty. In no event will the authors be held liable for any damages arising from the use of this software.

Permission is granted to anyone to use this software for any purpose, including commercial applications, and to alter it and redistribute it freely, subject to the following restrictions:

1. The origin of this software must not be misrepresented; you must not claim that you wrote the original software. If you use this software in a product, an acknowledgment in the product documentation would be appreciated but is not required.
2. Altered source versions must be plainly marked as such, and must not be misrepresented as being the original software.
3. This notice may not be removed or altered from any source distribution.

Package: Mbed TLS 2.16.1

© ARM Limited. All rights reserved.

The Mbed TLS package is subject to the license terms reprinted below:

Apache License

Version 2.0, January 2004

<http://www.apache.org/licenses/>

TERMS AND CONDITIONS FOR USE, REPRODUCTION, AND DISTRIBUTION

1. Definitions.
“License” shall mean the terms and conditions for use, reproduction, and distribution as defined by Sections 1 through 9 of this document.

“Licensor” shall mean the copyright owner or entity authorized by the copyright owner that is granting the License.

“Legal Entity” shall mean the union of the acting entity and all other entities that control, are controlled by, or are under common control with that entity. For the purposes of this definition, “control” means (i) the power, direct or indirect, to cause the direction or management of such entity, whether by contract or otherwise, or (ii) ownership of fifty percent (50%) or more of the outstanding shares, or (iii) beneficial ownership of such entity.

“You” (or “Your”) shall mean an individual or Legal Entity exercising permissions granted by this License.

“Source” form shall mean the preferred form for making modifications, including but not limited to software source code, documentation source, and configuration files.

“Object” form shall mean any form resulting from mechanical transformation or translation of a Source form, including but not limited to compiled object code, generated documentation, and conversions to other media types.

“Work” shall mean the work of authorship, whether in Source or Object form, made available under the License, as indicated by a copyright notice that is included in or attached to the work (an example is provided in the Appendix below).

“Derivative Works” shall mean any work, whether in Source or Object form, that is based on (or derived from) the Work and for which the editorial revisions, annotations, elaborations, or other modifications represent, as a whole, an original work of authorship. For the purposes of this License, Derivative Works shall not include works that remain separable from, or merely link (or bind by name) to the interfaces of, the Work and Derivative Works thereof.

“Contribution” shall mean any work of authorship, including the original version of the Work and any modifications or additions to that Work or Derivative Works thereof, that is intentionally submitted to Licensor for inclusion in the Work by the copyright owner or by an individual or Legal Entity authorized to submit on behalf of the copyright owner. For the purposes of this definition, “submitted” means any form of electronic, verbal, or written communication sent to the Licensor or its representatives, including but not limited to communication on electronic mailing lists, source code control systems, and issue tracking systems that are managed by, or on behalf of, the Licensor for the purpose of discussing and improving the Work, but excluding communication that is conspicuously marked or otherwise designated in writing by the copyright owner as “Not a Contribution.”

“Contributor” shall mean Licensor and any individual or Legal Entity on behalf of whom a Contribution has been received by Licensor and subsequently incorporated within the Work.

2. Grant of Copyright License. Subject to the terms and conditions of this License, each Contributor hereby grants to You a perpetual, worldwide, non-exclusive, no-charge, royalty-free, irrevocable copyright license to reproduce, prepare Derivative Works of, publicly display, publicly perform, sublicense, and distribute the Work and such Derivative Works in Source or Object form.
3. Grant of Patent License. Subject to the terms and conditions of this License, each Contributor hereby grants to You a perpetual, worldwide, non-exclusive, no-charge, royalty-free, irrevocable (except as stated in this section) patent license to make, have made, use, offer to sell, sell, import, and otherwise transfer the Work, where such license applies only to those patent claims licensable by such Contributor that are necessarily infringed by their Contribution(s) alone or by combination of their Contribution(s) with the Work to which such Contribution(s) was submitted. If You institute patent litigation against any entity (including a cross-claim or counterclaim in a lawsuit) alleging that the Work or a Contribution incorporated within the Work constitutes direct or contributory patent infringement, then any patent licenses granted to You under this License for that Work shall terminate as of the date such litigation is filed.
4. Redistribution. You may reproduce and distribute copies of the Work or Derivative Works thereof in any medium, with or without modifications, and in Source or Object form, provided that You meet the following conditions:
 - a. You must give any other recipients of the Work or Derivative Works a copy of this License; and
 - b. You must cause any modified files to carry prominent notices stating that You changed the files; and
 - c. You must retain, in the Source form of any Derivative Works that You distribute, all copyright, patent, trademark, and attribution notices from the Source form of the Work, excluding those notices that do not pertain to any part of the Derivative Works; and

d. If the Work includes a “NOTICE” text file as part of its distribution, then any Derivative Works that You distribute must include a readable copy of the attribution notices contained within such NOTICE file, excluding those notices that do not pertain to any part of the Derivative Works, in at least one of the following places: within a NOTICE text file distributed as part of the Derivative Works; within the Source form or documentation, if provided along with the Derivative Works; or, within a display generated by the Derivative Works, if and wherever such third-party notices normally appear. The contents of the NOTICE file are for informational purposes only and do not modify the License. You may add Your own attribution notices within Derivative Works that You distribute, alongside or as an addendum to the NOTICE text from the Work, provided that such additional attribution notices cannot be construed as modifying the License.

You may add Your own copyright statement to Your modifications and may provide additional or different license terms and conditions for use, reproduction, or distribution of Your modifications, or for any such Derivative Works as a whole, provided Your use, reproduction, and distribution of the Work otherwise complies with the conditions stated in this License.

5. Submission of Contributions. Unless You explicitly state otherwise, any Contribution intentionally submitted for inclusion in the Work by You to the Licensor shall be under the terms and conditions of this License, without any additional terms or conditions. Notwithstanding the above, nothing herein shall supersede or modify the terms of any separate license agreement you may have executed with Licensor regarding such Contributions.
6. Trademarks. This License does not grant permission to use the trade names, trademarks, service marks, or product names of the Licensor, except as required for reasonable and customary use in describing the origin of the Work and reproducing the content of the NOTICE file.
7. Disclaimer of Warranty. Unless required by applicable law or agreed to in writing, Licensor provides the Work (and each Contributor provides its Contributions) on an “AS IS” BASIS, WITHOUT WARRANTIES OR CONDITIONS OF ANY KIND, either express or implied, including, without limitation, any warranties or conditions of TITLE, NON-INFRINGEMENT, MERCHANTABILITY, or FITNESS FOR A PARTICULAR PURPOSE. You are solely responsible for determining the appropriateness of using or redistributing the Work and assume any risks associated with Your exercise of permissions under this License.
8. Limitation of Liability. In no event and under no legal theory, whether in tort (including negligence), contract, or otherwise, unless required by applicable law (such as deliberate and grossly negligent acts) or agreed to in writing, shall any Contributor be liable to You for damages, including any direct, indirect, special, incidental, or consequential damages of any character arising as a result of this License or out of the use or inability to use the Work (including but not limited to damages for loss of goodwill, work stoppage, computer failure or malfunction, or any and all other commercial damages or losses), even if such Contributor has been advised of the possibility of such damages.
9. Accepting Warranty or Additional Liability. While redistributing the Work or Derivative Works thereof, You may choose to offer, and charge a fee for, acceptance of support, warranty, indemnity, or other liability obligations and/or rights consistent with this License. However, in accepting such obligations, You may act only on Your own behalf and on Your sole responsibility, not on behalf of any other Contributor, and only if You agree to indemnify, defend, and hold each Contributor harmless for any liability incurred by, or claims asserted against, such Contributor by reason of your accepting any such warranty or additional liability.

END OF TERMS AND CONDITIONS

©2022 Bose Corporation

Licensed under the Apache License, Version 2.0 (the “License”); you may not use this file except in compliance with the License.

You may obtain a copy of the License at: <http://www.apache.org/licenses/LICENSE-2.0>

Unless required by applicable law or agreed to in writing, software distributed under the License is distributed on an “AS IS” BASIS, WITHOUT WARRANTIES OR CONDITIONS OF ANY KIND, either express or implied.

See the License for the specific language governing permissions and limitations under the License.

ZAWARTOŚĆ PAKIETU Z PRODUKTEM

Spis treści.....	13
------------------	----

APLIKACJA BOSE MUSIC

Pobieranie aplikacji Bose Music	14
Dodawanie słuchawek do istniejącego konta.....	14

ELEMENTY STEROWANIA SŁUCHAWKAMI

Włączanie zasilania.....	16
Wyłącznik czasowy.....	16
Wyłączanie zasilania.....	17
Funkcje słuchawek	18
Odtwarzanie multimediiów i regulacja głośności	18
Połączenia telefoniczne	19
Przycisk akcji	20

REDUKCJA SZUMÓW

Tryby redukcji szumów	21
Zmienianie trybu redukcji szumów	21

STEROWANIE GŁOSEM

Polecenia głosowe.....	22
------------------------	----

POŁĄCZENIA BLUETOOTH®

Łączenie przy użyciu menu <i>Bluetooth</i> urządzenia przenośnego	23
Rozłączanie urządzenia przenośnego.....	25
Ponowne łączenie z urządzeniem przenośnym.....	25
Połącz z kolejnym urządzeniem przenośnym	25
Identyfikowanie podłączonych urządzeń przenośnych.....	25
Przełączanie między dwoma podłączonymi urządzeniami przenośnymi	25
Ponowne łączenie z podłączonym wcześniej urządzeniem	26
Czyszczenie listy urządzeń słuchawek.....	26

POŁĄCZENIA PRZEWODOWE

Podłączanie przewodu audio.....	27
---------------------------------	----

BATERIA

Ładowanie baterii słuchawek.....	28
Czas ładowania.....	28
Odstuchiwanie wskazówki głosowej informującej o poziomie naładowania baterii.....	28

STAN SŁUCHAWEK

Stan <i>Bluetooth</i>	29
Stan baterii	29
Stan ładowania	30
Stan aktualizacji i błędy	30

ŁĄCZENIE PRODUKTÓW BOSE

Podłączanie głośnika Bose Smart Speaker lub listwy dźwiękowej Bose Smart Soundbar	31
Zalety.....	31
Zgodne produkty.....	31
Łączenie przy użyciu aplikacji Bose Music	31
Ponowne podłączanie głośnika Bose Smart Speaker lub Bose Smart Soundbar	32

KONSERWACJA

Przechowywanie słuchawek.....	33
Czyszczenie słuchawek	34
Części zamienne i akcesoria	34
Ograniczona gwarancja.....	34
Lokalizacja numeru seryjnego	35

ROZWIĄZYWANIE PROBLEMÓW

Podstawowe rozwiązania	36
Inne rozwiązania.....	36
Przywrócenie fabrycznych ustawień słuchawek	39

SPIS TREŚCI

Sprawdź, czy w pakiecie znajdują się poniższe elementy:



Bose QuietComfort 45 headphones

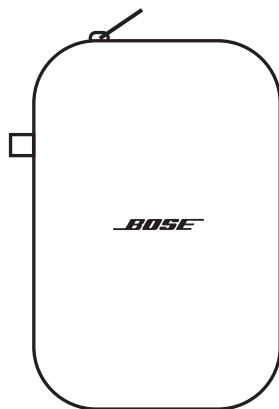

Miękki futerał



Przewód USB Type-C®

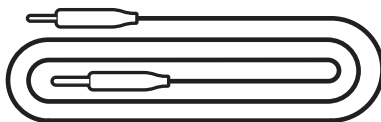

Przewód audio 3,5 mm – 2,5 mm

UWAGA: Nie wolno korzystać z produktu, jeżeli jakkolwiek jego część jest uszkodzona. W takiej sytuacji należy powiadomić autoryzowanego dystrybutora produktów firmy Bose lub Dział Obsługi Klientów tej firmy.

Skorzystaj z następującej witryny internetowej: support.Bose.com/QCSE

Aplikacja Bose Music pozwala skonfigurować słuchawki i sterować nimi przy użyciu urządzenia przenośnego takiego jak smartfon lub tablet.

Korzystając z aplikacji można zarządzać połączeniami *Bluetooth* i ustawieniami słuchawek, wybrać język komunikatów głosowych i uzyskać dostęp do nowych funkcji dzięki aktualizacjom.

UWAGA: W przypadku konta Bose Music, które zostało już utworzone dla innego produktu firmy Bose, należy dodać słuchawki do istniejącego konta (zobacz dolną część str. 14).

POBIERANIE APLIKACJI BOSE MUSIC

1. Pobierz aplikację Bose Music przy użyciu urządzenia przenośnego.

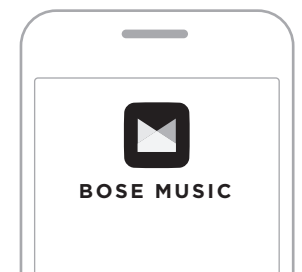

2. Postępuj zgodnie z instrukcjami wyświetlanymi w aplikacji.

DODAWANIE SŁUCHAWEK DO ISTNIEJĄCEGO KONTA

Aby dodać słuchawki Bose QuietComfort 45, należy otworzyć aplikację Bose Music i dodać słuchawki.

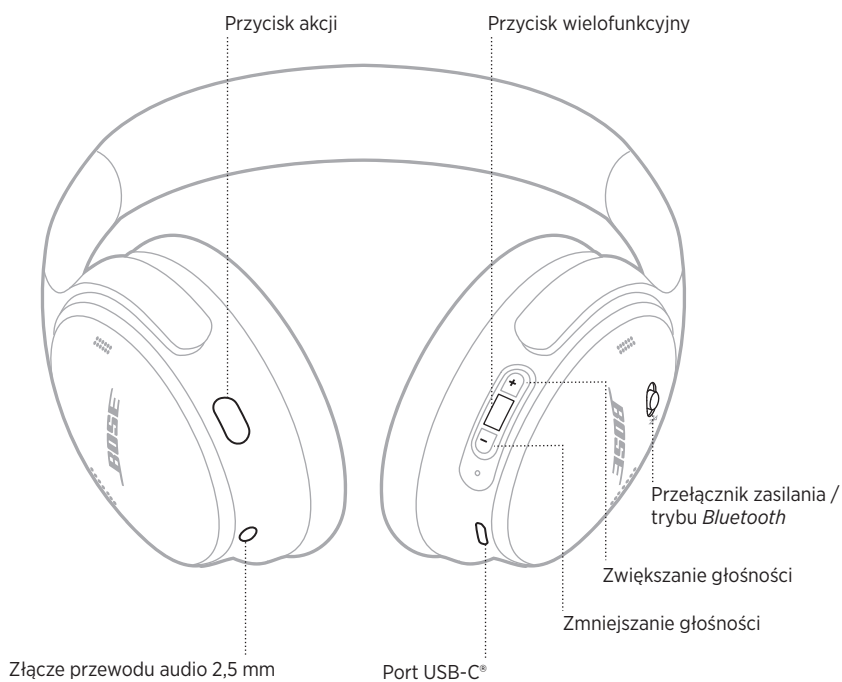

WŁĄCZANIE ZASILANIA

Na prawej muszli słuchawek przesunąć przełącznik zasilania / trybu *Bluetooth* w prawo.

Monit głosowy poinformuje o poziomie naładowania baterii, a wskaźnik stanu zaświeci w sposób zgodny z bieżącym poziomem naładowania (zob. str. 29).



Wyłącznik czasowy

Funkcja wyłącznika czasowego pozwala oszczędnie korzystać z baterii, gdy słuchawki nie są używane.

Aby skonfigurować i dostosować wyłącznik czasowy, należy skorzystać z aplikacji Bose Music.

WYŁĄCZANIE ZASILANIA

Przesuń przełącznik zasilania / trybu *Bluetooth* w lewo.



UWAGA: Po wyłączeniu słuchawek funkcja redukcji szumów jest dezaktywowana.

FUNKCJE SŁUCHAWEK

Elementy sterowania słuchawkami są umieszczone w tylnej części prawej muszli.

Odtwarzanie multimedialnych i regulacja głośności

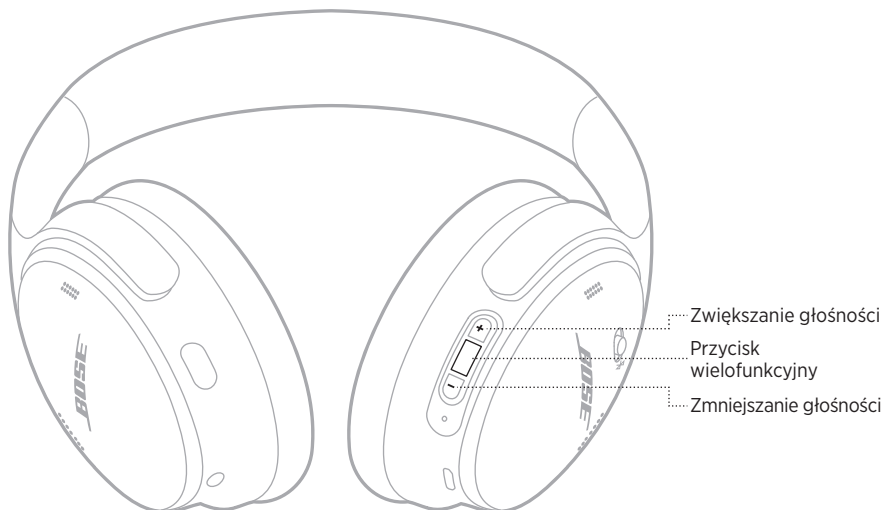

FUNKCJA	ROZWIĄZANIE
Rozpoczynanie/ wstrzymywanie odtwarzania	Naciśnij przycisk wielofunkcyjny.
Przechodzenie do przodu	Naciśnij dwukrotnie przycisk wielofunkcyjny.
Przechodzenie do tyłu	Naciśnij trzykrotnie przycisk wielofunkcyjny.
Zwiększanie głośności	Naciśnij przycisk +.
Zmniejszanie głośności	Naciśnij przycisk —.

UWAGI:

- Aby szybko zwiększyć głośność, naciśnij i przytrzymaj przycisk +.
- Aby szybko zmniejszyć głośność, naciśnij i przytrzymaj przycisk —.

Połączenia telefoniczne

Przycisk wielofunkcyjny znajduje się w tylnej części prawej muszli słuchawek. Mikrofon znajduje się niedaleko przedniej części prawej muszli słuchawek.

Przycisk akcji znajduje się w tylnej części lewej muszli słuchawek.

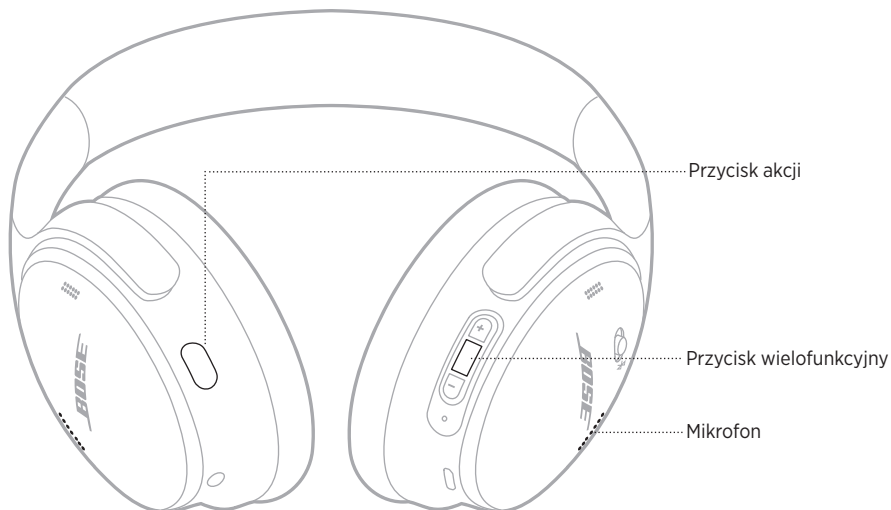

FUNKCJA	ROZWIĄZANIE
Odbieranie/kończenie połączenia	Naciśnij przycisk wielofunkcyjny.
Odrzucanie połączenia przychodzącego	Naciśnij przycisk wielofunkcyjny i przytrzymaj go przez sekundę.
Odbieranie nowego połączenia przychodzącego i zawieszanie bieżącej rozmowy	Gdy podczas rozmowy telefonicznej zabrzmi sygnał drugiego połączenia przychodzącego, naciśnij przycisk wielofunkcyjny.
Odrzucanie nowego połączenia przychodzącego i kontynuowanie bieżącej rozmowy	Gdy podczas rozmowy telefonicznej zabrzmi sygnał drugiego połączenia przychodzącego, naciśnij przycisk wielofunkcyjny i przytrzymaj go przez 1 sekundę.
Przełączanie między dwoma połączeniami	Gdy oba połączenia są aktywne, naciśnij dwukrotnie przycisk wielofunkcyjny.
Tworzenie połączenia konferencyjnego	Gdy oba połączenia są aktywne, naciśnij przycisk wielofunkcyjny i przytrzymaj go przez 3 sekundy.
Włączanie / Wyłączenie wyciszenia połączenia	Podczas rozmowy telefonicznej naciśnij dwukrotnie przycisk akcji.

Przycisk akcji

Za pomocą przycisku akcji można w prosty i szybki sposób zmieniać tryb redukcji szumów.

Przycisk akcji znajduje się w tylnej części lewej muszli słuchawek.



Aby przełączać pomiędzy trybem Cisza i Brak, naciśnij przycisk akcji.

Aby uzyskać więcej informacji dotyczących trybów redukcji szumów, zobacz str. 21.

Funkcja redukcji szumów blokuje niepożądany hałas i zakłócenia oraz zapewnia wierne odtwarzanie dźwięku. Można wybrać spośród dwóch trybów redukcji szumów: Cisza i Brak.

Tryb Cisza umożliwia zablokowanie rozpraszających dźwięków przy zastosowaniu najwyższego poziomu redukcji szumów.

Tryb Brak umożliwia słyszenie niezmiennych dźwięków otoczenia podczas korzystania ze słuchawek.

Poziom redukcji szumów można dostosować do własnych preferencji w zakresie odsłuchu i dźwięków w otoczeniu.

TRYBY REDUKCJI SZUMÓW

TRYB	OPIS
Cisza	Światowej klasy system redukcji szumów i zoptymalizowany dźwięk Bose.
Brak	Można korzystać ze słuchawek, słysząc jednocześnie dźwięki otoczenia.

UWAGA: Po włączeniu zasilania słuchawki domyślnie korzystają z ostatnio używanego trybu.

ZMIENIANIE TRYBU REDUKCJI SZUMÓW

Aby zmienić tryb redukcji szumów, naciśnij przycisk akcji.

Zostanie odtworzony monit głosowy informujący o wybranym trybie redukcji szumów.

PORADA: Tryb redukcji szumów można zmienić także przy użyciu aplikacji Bose Music.

POLECENIA GŁOSOWE

Słuchawek można używać do poleceń głosowych urządzenia przenośnego. Aby skorzystać z poleceń głosowych, naciśnij przycisk wielofunkcyjny i przytrzymaj go przez sekundę.

Przycisk wielofunkcyjny znajduje się w tylnej części prawej muszli słuchawek.

UWAGA: Podczas prowadzenia rozmowy nie można uzyskać dostępu do sterowania głosem.

ŁĄCZENIE PRZY UŻYCIU MENU *BLUETOOTH* URZĄDZENIA PRZENOŚNEGO

Na liście urządzeń słuchawek można zapisać maksymalnie osiem sparowanych urządzeń, ale nie można ustanowić aktywnego połączenia z kilkoma urządzeniami równocześnie. Nie można odtwarzać audio równocześnie z kilku urządzeń.

UWAGA: Aby uzyskać najlepsze rezultaty, użyj aplikacji Bose Music do skonfigurowania i podłączenia urządzenia przenośnego (zob. str. 14).

1. Przesuń przycisk zasilania / trybu *Bluetooth* w prawo \rightarrow i przytrzymaj przez 3 sekundy.

Usłyszysz komunikat głosowy informującą o gotowości do nawiązania połączenia, a niebieski wskaźnik stanu zacznie migać.



2. Włącz funkcję *Bluetooth* w urządzeniu.

UWAGA: Funkcja *Bluetooth* jest zwykle dostępna w menu Ustawienia.

3. Wybierz słuchawki z listy urządzeń.

PORADA: Wyszukaj nazwę słuchawek wprowadzoną w aplikacji Bose Music. Jeżeli nazwa słuchawek nie została określona, zostanie wyświetlona nazwa domyślna.



Po połączeniu zostanie odtworzony komunikat informujący o połączeniu z określonym urządzeniem (Connected to <nazwa urządzenia>), a niebieski wskaźnik stanu pozostanie włączony przez 10 sekund.

ROZŁĄCZANIE URZĄDZENIA PRZENOŚNEGO

Korzystając z aplikacji Bose Music, można rozłączyć połączenie urządzenia przenośnego.

PORADA: Urządzenie można też rozłączyć przy użyciu ustawień *Bluetooth*. Wyłączenie funkcji *Bluetooth* powoduje rozłączenie wszystkich pozostałych urządzeń.

PONOWNE ŁĄCZENIE Z URZĄDZENIEM PRZENOŚNYM

Słuchawki podczas włączania podejmują próbę ponownego połączenia z dwoma ostatnio podłączonymi urządzeniami.

UWAGI:

- Urządzenie musi znajdować się w zasięgu (9 m) i być włączone.
- Należy upewnić się, że funkcja *Bluetooth* jest włączona w urządzeniu przenośnym.

POŁĄCZ Z KOLEJNYM URZĄDZENIEM PRZENOŚNYM

Aby nawiązać połączenie z kolejnym urządzeniem, pobierz aplikację Bose Music (zob. str. 14) lub skorzystaj z menu *Bluetooth* w urządzeniu przenośnym (zob. str. 23).

UWAGA: Nie można odtwarzać audio z kilku urządzeń równocześnie.

IDENTYFIKOWANIE PODŁĄCZONYCH URZĄDZEŃ PRZENOŚNYCH

Aby usłyszeć, które urządzenie jest aktualnie połączone, przesunij przełącznik zasilania / trybu *Bluetooth* w prawo ✂ i zwolnij go.

PRZEŁĄCZANIE MIĘDZY DWOMA PODŁĄCZONYMI URZĄDZENIAMI PRZENOŚNYMI

1. Wstrzymaj odtwarzanie na pierwszym urządzeniu przenośnym.
2. Rozpocznij odtwarzanie audio na drugim urządzeniu przenośnym.

UWAGA: Za pomocą słuchawek można odbierać połączenia telefoniczne z obu urządzeń, niezależnie od tego, które z nich odtwarza dźwięk.

PONOWNE ŁĄCZENIE Z PODŁĄCZONYM WCZEŚNIEJ URZĄDZENIEM

1. Aby usłyszeć, które urządzenie jest połączone, przesunąć przełącznik zasilania / trybu *Bluetooth* w prawo ⌘ i zwolnij go.
2. Po upływie dwóch sekund ponownie przesunąć przełącznik w prawo ⌘ i ponownie go zwolnij, aby połączyć się z następnym urządzeniem na liście urządzeń słuchawek.
3. Powtarzaj tę czynność do momentu usłyszenia nazwy właściwego urządzenia.
Zostanie wyemitowany sygnał dźwiękowy informujący o ustanowieniu połączenia z urządzeniem.
4. Rozpocznij odtwarzanie audio na połączonym urządzeniu przenośnym.

UWAGA: Jeżeli do słuchawek podłączono już dwa urządzenia, nowo podłączane urządzenie zastąpi drugie uprzednio podłączone urządzenie.

CZYSZCZENIE LISTY URZĄDZEŃ SŁUCHAWEK

1. Przesunąć przełącznik zasilania/*Bluetooth* w prawo ⌘ i przytrzymaj go w tym położeniu przez 15 sekund — do momentu, aż usłyszysz powiadomienie o wyczyszczeniu listy urządzeń *Bluetooth* i gotowości do połączenia.
2. Usunąć słuchawki z listy *Bluetooth* na urządzeniu przenośnym.

Wszystkie pozycje listy urządzeń zostaną wyczyszczone a słuchawki będą gotowe do połączenia.

PODŁĄCZANIE PRZEWODU AUDIO

Przewód 2,5 mm do 3,5 mm umożliwia podłączenie urządzenia, które nie obsługuje łączności bezprzewodowej, lub słuchawek w przypadku rozładowania baterii.

1. Podłącz przewód do złącza 2,5 mm w lewej muszli słuchawek.



2. Podłącz drugie zakończenie przewodu do złącza 3,5 mm urządzenia.

UWAGA: Podczas korzystania z przewodu audio słuchawek można używać z włączonym lub wyłączonym zasilaniem.

ŁADOWANIE BATERII SŁUCHAWEK

1. Podłącz małą wtyczkę przewodu USB do złącza USB-C na prawej muszli słuchawek.
2. Podłącz drugi koniec przewodu do złącza USB ładowarki sieciowej.

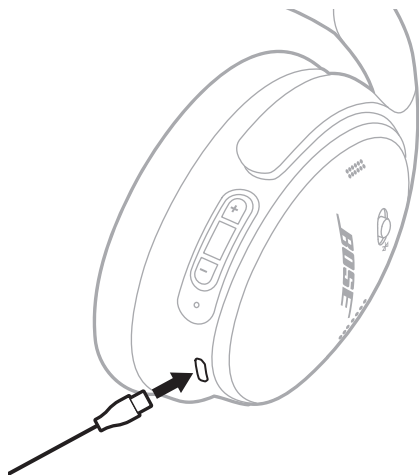

UWAGI:

- Gdy słuchawki zaczynają się ładować, biały wskaźnik stanu miga przez 10 sekund. Gdy bateria jest w pełni naładowana, biały wskaźnik stanu jest włączony.
- Podczas ładowania słuchawki nie działają.

Czas ładowania

Pełne ładowanie baterii słuchawek może trwać 2,5 godziny.

Odsluchiwanie wskazówki głosowej informującej o poziomie naładowania baterii

Zawsze po włączeniu zasilania słuchawek komunikat głosowy informuje o poziomie naładowania baterii. Jeżeli poziom naładowania baterii słuchawek jest niski, zostanie odtworzony komunikat informujący o konieczności naładowania baterii.

UWAGA: Wizualne sprawdzenie stanu baterii umożliwia wskaźnik stanu znajdujący się na prawej muszli słuchawek. Aby uzyskać więcej informacji, zobacz „Stan baterii” na str. 29.

Wskaźnik stanu znajduje się na prawej muszli słuchawek.



STAN BLUETOOTH

Informacje o stanie połączenia *Bluetooth*.

WSKAŹNIK	STAN SYSTEMU
Miga (niebieski)	Gotowość do połączenia
Włączony (niebieski; 10 sekund)	Podłączono

STAN BATERII

Wskazuje poziom naładowania baterii.

WSKAŹNIK	STAN SYSTEMU
Włączony (biały)	Poziom naładowania co najmniej średni
Włączony (bursztynowy)	Niski poziom naładowania

PORADA: Poziom naładowania baterii można również sprawdzić za pośrednictwem aplikacji Bose Music.

STAN ŁADOWANIA

Informacje o stanie ładowania.

WSKAŹNIK	STAN SYSTEMU
Miga (biały; 2 razy)	Rozpoczęcie ładowania
Włączony (bursztynowy)	Ładowanie
Włączony (biały)	Pełne naładowanie

STAN AKTUALIZACJI I BŁĘDY

Informacje o stanie aktualizacji lub o błędach.

WSKAŹNIK	STAN SYSTEMU
Miga szybko (biały; 10 sekund)	Aktualizacja oprogramowania (przez USB)
Miga powoli (biały; 30 do 60 sekund)	Aktualizacja oprogramowania (bezprowadowo)
Miga (bursztynowy i biały)	Błąd – skontaktuj się z Działem Obsługi Klientów firmy Bose

PODŁĄCZANIE GŁOŚNIKA BOSE SMART SPEAKER LUB LISTWY DŹWIĘKOWEJ BOSE SMART SOUNDBAR

Korzystając z technologii SimpleSync™ można podłączyć słuchawki do listwy dźwiękowej Bose Smart Soundbar lub głośnika Bose Smart Speaker, aby spersonalizować odtwarzanie audio.

Zalety

- Niezależna regulacja głośności w obu urządzeniach umożliwia zmniejszenie głośności lub wyciszenie listwy dźwiękowej Bose Soundbar Bose Smart Soundbar i równoczesne ustawienie dowolnej głośności słuchawek.
- Podłączając słuchawki do głośnika Bose Smart Speaker, można słuchać muzyki odtwarzanej w innym pomieszczeniu.

UWAGA: Technologia SimpleSync™ zapewnia zasięg do 9 m podobnie jak technologia *Bluetooth*. Ściany i materiały budowlane mogą niekorzystnie wpływać na odbiór.

Zgodne produkty

Słuchawki można połączyć z dowolnym głośnikiem Bose Smart Speaker lub listwą dźwiękową Bose Smart Soundbar.

Popularne zgodne produkty:

- Bose Smart Soundbar 700/Bose Soundbar 700
- Głośnik Bose Soundbar 500
- Bose Smart Speaker 500/Bose Home Speaker 500
- Bose Home Speaker 300
- Bose Portable Smart Speaker/Bose Portable Home Speaker

Okresowo dodawane są nowe produkty. Aby uzyskać pełną listę i więcej informacji, skorzystaj z następującej witryny internetowej: worldwide.Bose.com/Support/Groups

Łączenie przy użyciu aplikacji Bose Music

1. Na słuchawkach przesuń przycisk zasilania / trybu *Bluetooth* w prawo ✕ i przytrzymaj przez 3 sekundy.
Usłyszysz komunikat głosowy informujący o gotowości do podłączenia kolejnego urządzenia, a niebieski wskaźnik stanu zacznie migać.
2. Korzystając z aplikacji Bose Music, połącz słuchawki ze zgodnym produktem Bose. Aby uzyskać więcej informacji, skorzystaj z następującej witryny internetowej: worldwide.Bose.com/Support/Groups

UWAGI:

- Sprawdź, czy słuchawki znajdują się w odległości nie większej niż 9 m od listwy dźwiękowej lub głośnika.
- Nie można połączyć słuchawek z kilkoma urządzeniami równocześnie.

PONOWNE PODŁĄCZANIE GŁOŚNIKA BOSE SMART SPEAKER LUB BOSE SMART SOUNDBAR

Włącz słuchawki (zob. „Włączanie zasilania” na str. 16).

Słuchawki podejmują próbę połączenia z dwoma ostatnio podłączonymi urządzeniami *Bluetooth*, łącznie z listwą dźwiękową lub innymi głośnikami.

UWAGI:

- Listwa dźwiękowa lub głośnik muszą znajdować się w zasięgu (9 m) i być włączone.
- Jeżeli słuchawki nie łączą się ponownie, zobacz „Słuchawki nie łączą się ponownie z uprzednio podłączoną listwą dźwiękową Bose Smart Soundbar lub głośnikiem Bose Smart Speaker” na str. 38.

PRZECHOWYWANIE SŁUCHAWEK

Muszle słuchawek obracają się, co umożliwia wygodne ich przechowywanie. Umieść słuchawki płasko w futerałku.

1. Obróć obie muszle słuchawek do wewnątrz, aby ułożyć je płasko.

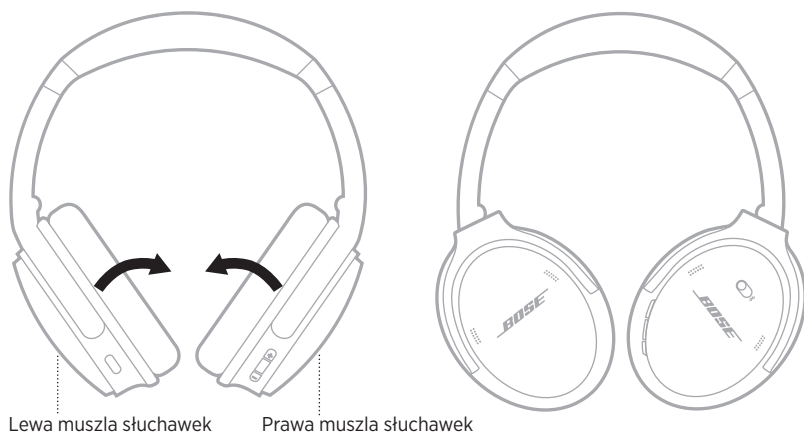

2. Złóż lewą muszlę słuchawek w kierunku pałąka.

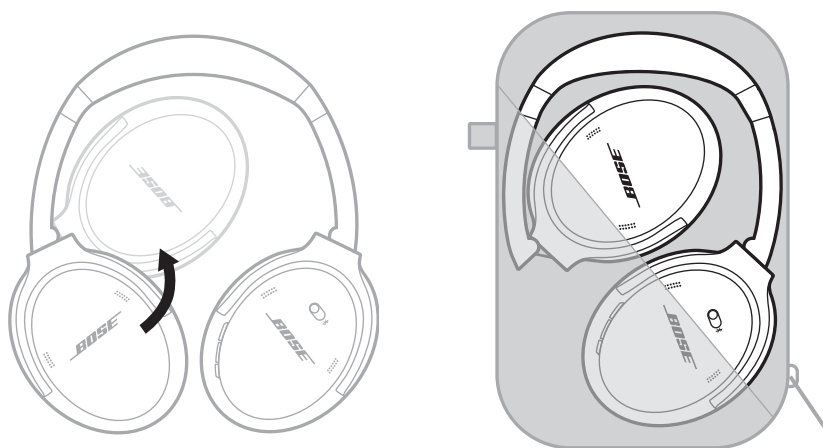

UWAGI:

- Słuchawki należy wyłączyć, jeżeli nie są używane.
- Jeżeli słuchawki nie będą używane przez okres dłuższy niż kilka miesięcy, należy całkowicie naładować baterię.

CZYSZCZENIE SŁUCHAWEK

Należy przetrzeć zewnętrzne elementy miękką, suchą ściereczką.

Nie należy dopuścić, by wilgoć dostała się do muszki słuchawek.

CZĘŚCI ZAMIENNE I AKCESORIA

Części zamienne i akcesoria można zamówić w Dziale Obsługi Klientów firmy Bose. Skorzystaj z następującej witryny internetowej: support.Bose.com/QCSE

OGRANICZONA GWARANCJA

Słuchawki są objęte ograniczoną gwarancją. Aby uzyskać informacje dotyczące ograniczonej gwarancji, skorzystaj z następującej witryny internetowej: worldwide.Bose.com/Warranty.

Aby uzyskać instrukcje dotyczące rejestrowania produktów, skorzystaj z następującej witryny internetowej: worldwide.Bose.com/ProductRegistration. Rezygnacja z rejestracji nie wpływa na uprawnienia wynikające z ograniczonej gwarancji.

LOKALIZACJA NUMERU SERYJNEGO

Numer seryjny znajduje się wewnątrz prawej muszli słuchawek pod siateczką. Jest to wewnętrzna osłona chroniąca elementy wewnątrz muszli słuchawek.

Aby sprawdzić numer seryjny, chwyć za górny brzeg osłony i delikatnie odciągnij ją.

PRZESTROGA: Należy zachować ostrożność, aby nie przycisnąć ani nie poluzować innych części wewnątrz muszli, ponieważ może to spowodować uszkodzenie słuchawek.

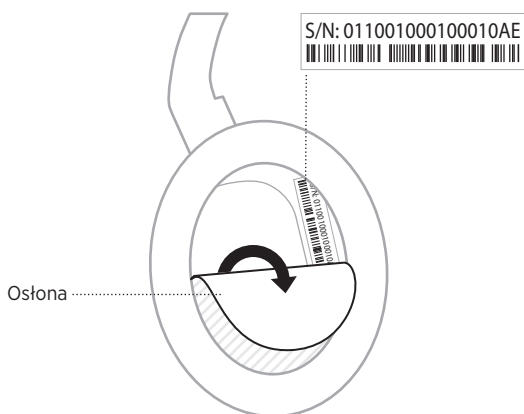

PODSTAWOWE ROZWIĄZANIA

W przypadku wystąpienia problemów ze słuchawkami:

- Sprawdź wskaźnik stanu (zob. str. 29).
- Naładuj baterię (zob. str. 28).
- Zwiększ poziom głośności słuchawek, urządzenia przenośnego i aplikacji muzycznej.
- Pobierz aplikację Bose Music i zainstaluj dostępne aktualizacje oprogramowania (zob. str. 14).
- Spróbuj podłączyć inne urządzenie przenośne (zob. str. 25).

Jeżeli pomimo zastosowania podstawowych rozwiązań problem wystąpi ponownie, skorzystaj z poniższej tabeli zawierającej informacje dotyczące typowych problemów i sposobów ich rozwiązywania. Jeżeli nie można rozwiązać problemu, skontaktuj się z Działem Obsługi Klientów firmy Bose.

Skorzystaj z następującej witryny internetowej: worldwide.Bose.com/contact

INNE ROZWIĄZANIA

PROBLEM	ROZWIĄZANIE
Słuchawki się nie włączają	Naładuj baterię.
Nie można połączyć słuchawek z urządzeniem przenośnym	<p>Odłącz zapasowy przewód audio. Odłącz przewód USB do ładowania. Na urządzeniu przenośnym: Wyłącz funkcję <i>Bluetooth</i> i włącz ją ponownie.</p> <p>Usuń słuchawki Bose QuietComfort 45 z listy <i>Bluetooth</i> na urządzeniu, w tym wszelkie duplikaty pozycji oznaczonych LE (Low Energy). Połącz ponownie.</p> <p>Zmniejsz odległość między urządzeniem przenośnym a słuchawkami i zwiększ odległość od źródeł zakłóceń lub przeszkód.</p> <p>Skorzystaj z witryny internetowej support.Bose.com/QCSE aby wyświetlić filmy instruktażowe.</p> <p>Wyczyść listę połączonych urządzeń (zob. str. 26) i przeprowadź ponownie łączenie.</p>
Bateria nie ładuje się	<p>Sprawdź pewność połączeń po obu stronach kabla USB do ładowania.</p> <p>Spróbuj użyć do ładowania innego źródła.</p> <p>Jeżeli słuchawki były wystawione na działanie wysokich lub niskich temperatur, poczekaj, aż znów osiągną temperaturę pokojową, i spróbuj ponownie rozpocząć ładowanie.</p>

PROBLEM	ROZWIĄZANIE
Brak dźwięku	<p>Włącz słuchawki i naładuj baterię.</p> <p>Sprawdź wskaźnik stanu (zob. str. 29).</p> <p>Aby usłyszeć, które urządzenie jest połączone, przesuń przycisk zasilania / trybu <i>Bluetooth</i> w prawo i zwolnij go. Upewnij się, że używasz odpowiedniego urządzenia.</p> <p>Zmniejsz odległość między urządzeniem przenośnym a słuchawkami i zwiększ odległość od źródeł zakłóceń lub przeszkód.</p> <p>Użyj innego źródła muzyki.</p> <p>Jeżeli połączone są dwa urządzenia przenośne, najpierw wstrzymaj odtwarzanie na drugim urządzeniu.</p> <p>Jeżeli podłączono dwa urządzenia przenośne, upewnij się, że znajdują się one w zasięgu słuchawek (9 m)</p> <p>Spróbuj odtworzyć muzykę lub wideo znajdujące w pamięci masowej urządzenia przenośnego.</p>
Niska jakość dźwięku	<p>Użyj innego źródła muzyki.</p> <p>Podłącz inne urządzenie przenośne (zob. str. 25).</p> <p>Odłącz drugie urządzenie.</p> <p>Zmniejsz odległość między urządzeniem przenośnym a słuchawkami i zwiększ odległość od źródeł zakłóceń lub przeszkód.</p> <p>Spróbuj odtworzyć muzykę lub wideo znajdujące w pamięci masowej urządzenia przenośnego.</p>
Brak dźwięku z urządzenia podłączonego przy użyciu zapasowego przewodu audio	<p>Sprawdź pewność połączeń po obu stronach zapasowego przewodu audio.</p> <p>Zwiększ poziom głośności słuchawek, urządzenia przenośnego i źródła muzyki.</p> <p>Podłącz inne urządzenie (zob. str. 25).</p>
Niska jakość dźwięku z urządzenia połączonego przy użyciu przewodu audio	<p>Sprawdź pewność połączeń po obu stronach zapasowego przewodu audio.</p> <p>Podłącz inne urządzenie (zob. str. 25).</p>
Przycisk akcji nie zmienia trybu redukcji szumów	<p>Sprawdź, czy słuchawki są włączone.</p> <p>W celu zmiany trybu redukcji szumów skorzystaj z aplikacji Bose Music.</p>

PROBLEM	ROZWIĄZANIE
Słuchawki nie łączą się z listwą dźwiękową Bose Smart Soundbar lub głośnikiem Bose Smart Speaker	<p>Przesuń przycisk zasilania/<i>Bluetooth</i> i przytrzymaj go do chwili, gdy usłyszysz powiadomienie o gotowości do nawiązania połączenia z kolejnym urządzeniem, a niebieski wskaźnik <i>Bluetooth</i> zacznie migać.</p> <p>Sprawdź, czy słuchawki znajdują się w odległości nie większej niż 9 m od listwy dźwiękowej lub głośnika.</p>
Słuchawki nie łączą się ponownie z uprzednio podłączoną listwą dźwiękową Bose Smart Soundbar lub głośnikiem Bose Smart Speaker	<p>Podłącz uprzednio podłączone urządzenie (zob. str. 26).</p>
Opóźniony dźwięk po połączeniu z listwą dźwiękową Bose Smart Soundbar lub głośnikiem Bose Smart Speaker	<p>Pobierz aplikację Bose Music i zainstaluj dostępne aktualizacje oprogramowania.</p>

Przywrócenie ustawień fabrycznych spowoduje zresetowanie wszystkich ustawień i przywrócenie słuchawek do początkowego stanu. Następnie słuchawki można skonfigurować w taki sposób, jakby były konfigurowane po raz pierwszy.

Przywrócenie ustawień fabrycznych zalecane jest wyłącznie wówczas, gdy występują problemy ze słuchawkami lub zostało to zaproponowane przez Dział Obsługi Klientów firmy Bose.

PRZYWRÓCENIE FABRYCZNYCH USTAWIEŃ SŁUCHAWEK

1. Usuń słuchawki z listy *Bluetooth* urządzenia.
2. Usuń słuchawki z konta Bose przy użyciu aplikacji Bose Music.

UWAGA: Aby dowiedzieć się, jak usunąć słuchawki z konta Bose przy użyciu aplikacji Bose Music, skorzystaj ze strony internetowej: support.Bose.com/QCSE

3. Przesuń przycisk zasilania / trybu *Bluetooth* w prawo ⌘ i przytrzymaj. Jednocześnie naciśnij przycisk akcji i przytrzymaj go przez 30 sekund. Biały wskaźnik stanu miga. Po 30 sekundach wskaźnik stanu miga na bursztynowo, sygnalizując trwanie procesu przywracania ustawień fabrycznych (2 do 3 sekund).
4. Po ukończeniu resetowania niebieski wskaźnik stanu powoli miga. Słuchawki są teraz w oryginalnym stanie, jak po wyjęciu z pudełka.

Läs igenom och spara alla anvisningar om skydd, säkerhet och användning.

CE Härmed förklarar Bose Corporation att denna produkt i alla väsentliga avseenden uppfyller de krav och föreskrifter som uppställts enligt direktivet 2014/53/EG och andra tillämpliga EG-direktiv. En komplett försäkran om överensstämmelse finns på www.Bose.com/compliance

UK CA Denna produkt följer alla tillämpliga förordningar för elektromagnetisk kompatibilitet (Electromagnetic Compatibility Regulations 2016) och alla andra tillämpliga förordningar i Storbritannien. En komplett försäkran om överensstämmelse finns på www.Bose.com/compliance

Bose Corporation intygar härmed att den här produkten uppfyller kraven enligt förordningarna för radioutrustning (Radio Equipment Regulations 2017) och andra tillämpliga förordningar i Storbritannien. En komplett försäkran om överensstämmelse finns på www.Bose.com/compliance

Viktiga säkerhetsanvisningar

Använd inte produkten i närheten av vatten.

Rengör endast med en torr trasa.

Låt utbildad personal utföra all service. Underhåll krävs när apparaten skadats på något sätt, t.ex. om elkabel eller kontakt har skadats, vätska har spillts i apparaten eller främmande föremål har hamnat i den, om apparaten har utsatts för regn eller fukt, om apparaten inte fungerar felfritt eller har tappats.

VARNINGAR/TÄNK PÅ

- Använd INTE hörlurarna med hög volym under en längre tidsperiod.
 - Du undviker hörselskador om du använder hörlurarna med en bekväm och medelhög ljudnivå.
 - Skruva ned volymen på enheten innan du sätter på dig hörlurarna. Skruva sedan upp volymen stegvis tills den når en behaglig nivå.
- Använd INTE hörlurarna för att prata i telefon eller i annat syfte när du framför ett fordon.
- Använd INTE hörlurarna i brusreduceringsläge vid tillfällen då det kan vara farligt att inte höra omgivningen t.ex. när du cyklar, rör dig i trafiken, är i närheten av byggarbetsplatser, järnvägar etc, och följ tillämpliga lagar gällande användning av hörlurar.
 - Stäng av hörlurarna eller använd dem utan brusreducering, och justera volymen för att försäkra dig om att du hör ljud från omgivningen, inklusive larm och varningssignaler.
 - Var uppmärksam på hur ljud som du upplever som påminnelser eller varningar kan förändras när du använder hörlurarna. Detta gäller även i läget Uppmärksam.
- Använd INTE hörlurarna om de utsänder högt, onormalt ljud. Om detta händer ska du stänga av hörlurarna och kontakta Bose kundtjänst.
- Ta omedelbart bort och koppla från öronsnäckorna om du märker att de blir varma eller att ljudet försvinner.
- Använd INTE adaptrar avsedda för mobiltelefoner för att ansluta hörlurarna till kontakter vid flygplansstolar, eftersom du då riskerar att skadas eller att föremål skadas på grund av överhettning.
- Använd INTE hörlurarna som kommunikationsheadset i flygplan.



Produkten innehåller små delar som kan utgöra kvävningsrisker. Inte lämplig för barn under 3 år.



Produkten innehåller magnetiska material. Konsultera vid behov en läkare för att ta reda på om medicinska implantat kan påverkas av detta.

- Utsätt, för att minska risken för brand eller elstötar, INTE produkten för regn, stänk, droppar eller fukt och placera inga vätskefyllda föremål, som exempelvis vaser, på eller i dess närhet.
- Se till att produkten inte kommer i närheten av öppen eld eller heta värmekällor. Tända ljus eller andra föremål med öppna lågor får INTE placeras på eller i närheten av produkten.
- Produkten ska endast användas tillsammans med en godkänd LPS-adapter (begränsad strömkälla) som uppfyller lokala bestämmelser (till exempel UL, CSA, VDE eller CCC).
- Gör INGA obehöriga ändringar av produkten.
- Om batteriet börjar läcka måste du skydda dig så att vätskan inte kommer i kontakt med huden eller ögonen. Om detta sker bör du rådfråga en sjukvårdscentral.
- Utsätt inte produkter som innehåller batterier för höga temperaturer (t.ex. från direkt solljus, öppen eld eller liknande)
- Använd INTE medan de laddas.

OBS! Den här utrustningen har testats och befunnits överensstämma med gränsvärdena för digitala enheter enligt klass B, i enlighet med del 15 i FCC:s bestämmelser. Gränsvärdena är avsedda att ge rimligt skydd mot skadliga störningar vid installation i bostäder. Den här utrustningen genererar, använder och kan avge radiofrekvensenergi, och om utrustningen inte installeras och används i enlighet med anvisningarna kan den orsaka skadliga störningar i samband med radiokommunikation. Det ges dock ingen garanti för att det inte kan förekomma skadliga störningar i en viss installation. Om den här utrustningen stör mottagningen i en radio- eller TV-apparat (vilket kan upptäckas genom att utrustningen stängs av och sätts på) rekommenderar vi att du försöker motverka störningen genom att vidta en eller flera av följande åtgärder:

- Rikta om eller flytta den mottagande produkten eller antennen.
- Öka avståndet mellan utrustningen och mottagaren.
- Anslut utrustningen till ett vägguttag i en annan strömkrets än den som mottagaren är ansluten till.
- Vänd dig till din återförsäljare eller en erfaren radio-/TV-reparatör för att få hjälp.

Om utrustningen ändras eller modifieras på något sätt, som inte uttryckligen har godkänts av Bose Corporation, kan det medföra att användarens rätt att använda produkten upphävs.

Denna enhet uppfyller del 15 i FCC-bestämmelserna och licensundantaget i ISED Canada angående RSS-standarder. Följande två villkor ställs för användningen: (1) Enheten får inte orsaka skadliga störningar och (2) enheten måste tåla alla former av störningar som den tar emot, inklusive störningar som kan orsaka oönskad drift av enheten.

Denna enhet uppfyller FCC- och ISED Canada-bestämmelserna angående gränsvärden som är uppställda för strålningsexponering för produkter för generella användningsområden. Sändaren får inte sammankopplas eller användas tillsammans med någon annan antenn eller sändare.

Uppfyller kraven i IMDA.

FCC ID: A94437310

IC: 3232A-437310

CAN ICES-3(B)/NMB-3(B)

För Europa:

Frekvensband som används: 2400 till 2483,5 MHz.

Maximal överföringsstyrka mindre än 20 dBm EIRP.

Maximal överföringsstyrka är mindre än lagstadgade gränser så att SAR-testning inte är nödvändigt och undantaget per gällande bestämmelser.



Den här symbolen betyder att produkten inte ska kastas med hushållssoporna utan återvinnas i enlighet med lokala bestämmelser. Rätt deponering och återvinning hjälper till att skydda våra naturresurser, vår hälsa och miljö. Mer information om deponering och återvinning av produkten får du om du kontaktar lokala myndigheter, deponeringscentraler eller affären där du köpte produkten.

Tekniska förordningar för lågströmsenheter med radiofrekvenser

Utän tillstånd beviljat av NCC, är företag, organisationer eller användare inte tillåtna att ändra frekvensen, förstärka överföringsstyrkan eller ändra ursprungliga egenskaper och prestanda för en godkänd radiofrekvensenhet med låg effekt. Radiofrekvensenheter med låg effekt får inte påverka flygsäkerheten eller störa annan legal kommunikation. Om detta uppmärksammas ska användaren omedelbart upphöra med att använda enheten tills det inte finns någon risk för sådana störningar. Med nämnda legala kommunikationer avses radiokommunikationer som sker i enlighet med gällande Telecommunications Management Act. Radiofrekvensenheter med låg effekt måste vara mottagliga för störningar från legala kommunikationer och enheter som sänder ut ISM-radiovågor.

Försök INTE ta bort det uppladdningsbara litiumbatteriet från produkten. Kontakta en Bose-återförsäljare eller en kvalificerad tekniker om det behöver tas bort.

Litiumbatteriet i den här produkten får endast tas bort av kvalificerad person. Kontakta en Bose-återförsäljare eller gå till products.bose.com/static/compliance/index.html för att få mer information.



Tänk på att lämna in gamla batterier för återvinning enligt lokala föreskrifter. Elda inte upp batterier.



Namn och innehåll på giftiga eller farliga ämnen eller delar						
Namn	Giftiga eller farliga ämnen och delar					
	Bly (Pb)	Kvicksilver (Hg)	Kadmium (Cd)	Sexvärt krom (CR(VI))	Polybromerade bifenyler (PBB)	Polybromerade difenyleter (PBDE)
PCB:er	x	0	0	0	0	0
Metalldelar	x	0	0	0	0	0
Plastdelar	0	0	0	0	0	0
Högtalare	x	0	0	0	0	0
Kablar	x	0	0	0	0	0
Den här tabellen är uppställd i enlighet med bestämmelserna i SJ/T 11364. O: Anger att detta giftiga eller farliga ämne som ingår i alla homogena material i den här artikeln ligger under gränsvärdena uppställda i GB/T 26572. x: Anger att detta giftiga eller farliga ämne som ingår i minst ett av de homogena materialen i den här artikeln ligger över gränsvärdena uppställda i GB/T 26572.						

Tillverkningsdatum: Den åttonde siffran i serienumret visar tillverkningsåret; "2" är 2012 eller 2022.

Kinaimportör: Bose Electronics (Shanghai) Company Limited, Level 6, Tower D, No. 2337 Gudai Rd. Minhang District, Shanghai 201100

EU-importör: Bose Products B.V., Gorslaan 60, 1441 RG Purmerend, Nederländerna

Mexikoimportör: Bose de México S. de R.L. de C.V., Avenida Prado Sur #150, Piso 2, Interior 222 y 223, Colonia Lomas de Chapultepec V Sección, Miguel Hidalgo, Ciudad de México, C.P. 11000 Telefonnummer: +5255 (5202) 3545

Taiwanimportör: Bose Limited Taiwan Branch (H.K.), 9F., No. 10, Sec. 3, Minsheng E. Road, Zhongshan Dist. Taipei City 10480, Taiwan Telefonnummer: +886-2-2514 7676

UK-importör: Bose Limited, Bose House, Quayside Chatham Maritime, Chatham, Kent, ME4 4QZ, Storbritannien

Märkspänning: 5 V --- 0,5 A

Temperaturintervall för laddning: 0° C till 45° C

Temperaturintervall för urladdning: -20 °C till 60 °C

Modell 437310. CMIIT ID är placerat på insidan av hörluren under nätet.

Fyll i uppgifterna och spara dem för senare bruk

Serie- och modellnumret finns på hörlurens insida under nätet.

Serienummer: _____

Modellnummer: _____

Förvara kvittot tillsammans med bruksanvisningen. Det är nu dags att registrera Bose-produkten. Du gör det enklast genom att gå till webbplatsen [worldwide.bose.com/ProductRegistration](https://www.worldwide.bose.com/ProductRegistration)

Säkerhetsinformation



Denna produkt kan ta emot säkerhetsuppdateringar automatiskt från Bose när den är ansluten till Bose Music-appen. För att ta emot säkerhetsuppdateringar via mobilappen måste du slutföra produktinstallationen i Bose Music-appen. **Om du inte slutför installationen blir du ansvarig för att installera säkerhetsuppdateringar som Bose gör tillgängliga via btu.bose.com**

Apple, Apple-logotypen, iPad, iPhone och iPod är varumärken som tillhör Apple Inc. i USA och i andra länder. App Store är ett servicemärke som tillhör Apple Inc. Varumärket "iPhone" används i Japan under licens från Aiphone K.K.

Användning av Made for Apple-symbolen betyder att ett tillbehör har tillverkats speciellt för att anslutas till Apple-produkten/-produkterna som identifieras i symbolen och att de har certifierats av utvecklaren för att uppfylla Apple-prestandastandarder. Apple ansvarar inte för hur enheten fungerar eller att den är kompatibel med säkerhetsstandarder och andra standarder.

Namnet *Bluetooth*[®] och logotyperna är registrerade varumärken som tillhör Bluetooth SIG, Inc., och all användning av sådana märken från Bose Corporation sker under licens.

Google Play är ett varumärke som tillhör Google LLC.

USB Type-C[®] och USB-C[®] är registrerade varumärken som tillhör USB Implementers Forum.

Bose, Bose Home Speaker, Bose Music, Bose Musics logotyp, Bose Smart Soundbar, Bose Smart Speaker, Bose Soundbar, QuietComfort, och SimpleSync är varumärken som tillhör Bose Corporation.

Bose Corporations huvudkontor: 1-877-230-5639

©2022 Bose Corporation. Ingen del av detta dokument får återges, modifieras, distribueras eller användas på något annat sätt utan föregående skriftlig tillåtelse.

The following license disclosures apply to certain third-party software packages used as components in the product.

Package: FreeRTOS

Copyright © Amazon Web Services, Inc. or its affiliates. All rights reserved.

The FreeRTOS package is subject to the license terms reprinted below:

MIT License

Permission is hereby granted, free of charge, to any person obtaining a copy of this software and associated documentation files (the “Software”), to deal in the Software without restriction, including without limitation the rights to use, copy, modify, merge, publish, distribute, sublicense, and/or sell copies of the Software, and to permit persons to whom the Software is furnished to do so, subject to the following conditions:

The above copyright notice and this permission notice shall be included in all copies or substantial portions of the Software.

THE SOFTWARE IS PROVIDED “AS IS”, WITHOUT WARRANTY OF ANY KIND, EXPRESS OR IMPLIED, INCLUDING BUT NOT LIMITED TO THE WARRANTIES OF MERCHANTABILITY, FITNESS FOR A PARTICULAR PURPOSE AND NONINFRINGEMENT. IN NO EVENT SHALL THE AUTHORS OR COPYRIGHT HOLDERS BE LIABLE FOR ANY CLAIM, DAMAGES OR OTHER LIABILITY, WHETHER IN AN ACTION OF CONTRACT, TORT OR OTHERWISE, ARISING FROM, OUT OF OR IN CONNECTION WITH THE SOFTWARE OR THE USE OR OTHER DEALINGS IN THE SOFTWARE.

Package: Nanopb

Copyright © 2011 Petteri Aimonen <jpa at nanopb.mail.kapsi.fi>.

The Nanopb package is subject to the license terms reprinted below:

Zlib License

© 2011 Petteri Aimonen <jpa at nanopb.mail.kapsi.fi>

This software is provided ‘as-is’, without any express or implied warranty. In no event will the authors be held liable for any damages arising from the use of this software.

Permission is granted to anyone to use this software for any purpose, including commercial applications, and to alter it and redistribute it freely, subject to the following restrictions:

1. The origin of this software must not be misrepresented; you must not claim that you wrote the original software. If you use this software in a product, an acknowledgment in the product documentation would be appreciated but is not required.
2. Altered source versions must be plainly marked as such, and must not be misrepresented as being the original software.
3. This notice may not be removed or altered from any source distribution.

Package: Mbed TLS 2.16.1

© ARM Limited. All rights reserved.

The Mbed TLS package is subject to the license terms reprinted below:

Apache License

Version 2.0, January 2004

<http://www.apache.org/licenses/>

TERMS AND CONDITIONS FOR USE, REPRODUCTION, AND DISTRIBUTION

1. Definitions.
“License” shall mean the terms and conditions for use, reproduction, and distribution as defined by Sections 1 through 9 of this document.

“Licensor” shall mean the copyright owner or entity authorized by the copyright owner that is granting the License.

“Legal Entity” shall mean the union of the acting entity and all other entities that control, are controlled by, or are under common control with that entity. For the purposes of this definition, “control” means (i) the power, direct or indirect, to cause the direction or management of such entity, whether by contract or otherwise, or (ii) ownership of fifty percent (50%) or more of the outstanding shares, or (iii) beneficial ownership of such entity.

“You” (or “Your”) shall mean an individual or Legal Entity exercising permissions granted by this License.

“Source” form shall mean the preferred form for making modifications, including but not limited to software source code, documentation source, and configuration files.

“Object” form shall mean any form resulting from mechanical transformation or translation of a Source form, including but not limited to compiled object code, generated documentation, and conversions to other media types.

“Work” shall mean the work of authorship, whether in Source or Object form, made available under the License, as indicated by a copyright notice that is included in or attached to the work (an example is provided in the Appendix below).

“Derivative Works” shall mean any work, whether in Source or Object form, that is based on (or derived from) the Work and for which the editorial revisions, annotations, elaborations, or other modifications represent, as a whole, an original work of authorship. For the purposes of this License, Derivative Works shall not include works that remain separable from, or merely link (or bind by name) to the interfaces of, the Work and Derivative Works thereof.

“Contribution” shall mean any work of authorship, including the original version of the Work and any modifications or additions to that Work or Derivative Works thereof, that is intentionally submitted to Licensor for inclusion in the Work by the copyright owner or by an individual or Legal Entity authorized to submit on behalf of the copyright owner. For the purposes of this definition, “submitted” means any form of electronic, verbal, or written communication sent to the Licensor or its representatives, including but not limited to communication on electronic mailing lists, source code control systems, and issue tracking systems that are managed by, or on behalf of, the Licensor for the purpose of discussing and improving the Work, but excluding communication that is conspicuously marked or otherwise designated in writing by the copyright owner as “Not a Contribution.”

“Contributor” shall mean Licensor and any individual or Legal Entity on behalf of whom a Contribution has been received by Licensor and subsequently incorporated within the Work.

2. Grant of Copyright License. Subject to the terms and conditions of this License, each Contributor hereby grants to You a perpetual, worldwide, non-exclusive, no-charge, royalty-free, irrevocable copyright license to reproduce, prepare Derivative Works of, publicly display, publicly perform, sublicense, and distribute the Work and such Derivative Works in Source or Object form.
3. Grant of Patent License. Subject to the terms and conditions of this License, each Contributor hereby grants to You a perpetual, worldwide, non-exclusive, no-charge, royalty-free, irrevocable (except as stated in this section) patent license to make, have made, use, offer to sell, sell, import, and otherwise transfer the Work, where such license applies only to those patent claims licensable by such Contributor that are necessarily infringed by their Contribution(s) alone or by combination of their Contribution(s) with the Work to which such Contribution(s) was submitted. If You institute patent litigation against any entity (including a cross-claim or counterclaim in a lawsuit) alleging that the Work or a Contribution incorporated within the Work constitutes direct or contributory patent infringement, then any patent licenses granted to You under this License for that Work shall terminate as of the date such litigation is filed.
4. Redistribution. You may reproduce and distribute copies of the Work or Derivative Works thereof in any medium, with or without modifications, and in Source or Object form, provided that You meet the following conditions:
 - a. You must give any other recipients of the Work or Derivative Works a copy of this License; and
 - b. You must cause any modified files to carry prominent notices stating that You changed the files; and
 - c. You must retain, in the Source form of any Derivative Works that You distribute, all copyright, patent, trademark, and attribution notices from the Source form of the Work, excluding those notices that do not pertain to any part of the Derivative Works; and

d. If the Work includes a “NOTICE” text file as part of its distribution, then any Derivative Works that You distribute must include a readable copy of the attribution notices contained within such NOTICE file, excluding those notices that do not pertain to any part of the Derivative Works, in at least one of the following places: within a NOTICE text file distributed as part of the Derivative Works; within the Source form or documentation, if provided along with the Derivative Works; or, within a display generated by the Derivative Works, if and wherever such third-party notices normally appear. The contents of the NOTICE file are for informational purposes only and do not modify the License. You may add Your own attribution notices within Derivative Works that You distribute, alongside or as an addendum to the NOTICE text from the Work, provided that such additional attribution notices cannot be construed as modifying the License.

You may add Your own copyright statement to Your modifications and may provide additional or different license terms and conditions for use, reproduction, or distribution of Your modifications, or for any such Derivative Works as a whole, provided Your use, reproduction, and distribution of the Work otherwise complies with the conditions stated in this License.

5. Submission of Contributions. Unless You explicitly state otherwise, any Contribution intentionally submitted for inclusion in the Work by You to the Licensor shall be under the terms and conditions of this License, without any additional terms or conditions. Notwithstanding the above, nothing herein shall supersede or modify the terms of any separate license agreement you may have executed with Licensor regarding such Contributions.
6. Trademarks. This License does not grant permission to use the trade names, trademarks, service marks, or product names of the Licensor, except as required for reasonable and customary use in describing the origin of the Work and reproducing the content of the NOTICE file.
7. Disclaimer of Warranty. Unless required by applicable law or agreed to in writing, Licensor provides the Work (and each Contributor provides its Contributions) on an “AS IS” BASIS, WITHOUT WARRANTIES OR CONDITIONS OF ANY KIND, either express or implied, including, without limitation, any warranties or conditions of TITLE, NON-INFRINGEMENT, MERCHANTABILITY, or FITNESS FOR A PARTICULAR PURPOSE. You are solely responsible for determining the appropriateness of using or redistributing the Work and assume any risks associated with Your exercise of permissions under this License.
8. Limitation of Liability. In no event and under no legal theory, whether in tort (including negligence), contract, or otherwise, unless required by applicable law (such as deliberate and grossly negligent acts) or agreed to in writing, shall any Contributor be liable to You for damages, including any direct, indirect, special, incidental, or consequential damages of any character arising as a result of this License or out of the use or inability to use the Work (including but not limited to damages for loss of goodwill, work stoppage, computer failure or malfunction, or any and all other commercial damages or losses), even if such Contributor has been advised of the possibility of such damages.
9. Accepting Warranty or Additional Liability. While redistributing the Work or Derivative Works thereof, You may choose to offer, and charge a fee for, acceptance of support, warranty, indemnity, or other liability obligations and/or rights consistent with this License. However, in accepting such obligations, You may act only on Your own behalf and on Your sole responsibility, not on behalf of any other Contributor, and only if You agree to indemnify, defend, and hold each Contributor harmless for any liability incurred by, or claims asserted against, such Contributor by reason of your accepting any such warranty or additional liability.

END OF TERMS AND CONDITIONS

©2022 Bose Corporation

Licensed under the Apache License, Version 2.0 (the “License”); you may not use this file except in compliance with the License.

You may obtain a copy of the License at: <http://www.apache.org/licenses/LICENSE-2.0>

Unless required by applicable law or agreed to in writing, software distributed under the License is distributed on an “AS IS” BASIS, WITHOUT WARRANTIES OR CONDITIONS OF ANY KIND, either express or implied.

See the License for the specific language governing permissions and limitations under the License.

VAD FINNS I FÖRPACKNINGEN?

Innehåll.....	13
---------------	----

BOSE MUSIC-APPEN

Hämta Bose Music-appen.....	14
Lägga till hörlurarna till ett befintligt konto.....	14

KONTROLLER PÅ HÖRLURARNA

Ström på.....	16
Vilolägesklocka.....	16
Stänga av	17
Hörlursfunktioner	18
Medieuppspelning och volym.....	18
Telefonsamtal	19
Åtgärdsknapp.....	20

BRUSREDUCERING

Brusreduceringslägen	21
Ändra läget för brusreducering.....	21

RÖSTSTYRNING

Komma åt röstkontroller	22
-------------------------------	----

BLUETOOTH®-ANSLUTNINGAR

Ansluta via <i>Bluetooth</i> -menyn på den mobila enheten.....	23
Koppla från en mobil enhet	25
Återansluta en mobil enhet.....	25
Ansluta ytterligare en mobil enhet	25
Identifiera anslutna mobila enheter	25
Växla mellan två anslutna mobila enheter	25
Återansluta till en tidigare ansluten enhet.....	26
Rensa hörlurarnas enhetslista	26

TRÅDBUNDNA ANSLUTNINGAR

Ansluta ljudkabeln	27
--------------------------	----

BATTERI

Ladda upp hörlurarna	28
Laddningstid.....	28
Höra laddningsnivån.....	28

HÖRLURARNAS STATUSINDIKATORER

<i>Bluetooth</i> -status	29
Batteristatus	29
Laddningsstatus	30
Uppdatering och felstatus	30

ANSLUTA BOSE-PRODUKTER

Ansluta en Bose Smart Speaker eller soundbarhögtalare.....	31
Fördelar	31
Kompatibla produkter.....	31
Ansluta med Bose Music-appen	31
Återansluta med en Bose Smart Speaker eller Soundbar	32

SKÖTSEL OCH UNDERHÅLL

Förvara hörlurarna.....	33
Rengöra hörlurarna	34
Reservdelar och tillbehör.....	34
Begränsad garanti	34
Plats för serienummer	35

FELSÖKNING

Prova det här först..... 36

Andra lösningar 36

Återställa hörlurarna till fabriksinställningarna..... 39

INNEHÅLL

Kontrollera att du har följande:



Bose QuietComfort 45 headphones

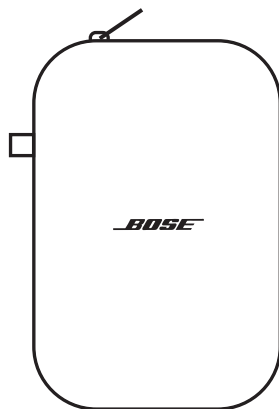

Mjuk bärväska



USB Type-C®-kabel

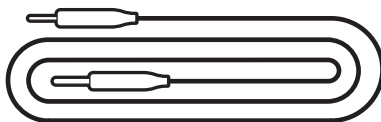

3,5 mm till 2,5 mm ljudkabel

OBS! Om någon del av produkten är skadad ska du inte använda den. Kontakta en Bose-återförsäljare eller Bose kundtjänst.

Besök: support.Bose.com/QCSE

Med Bose Music-appen kan du ställa in och styra dina hörlurar från valfri mobil enhet som t.ex. en smarttelefon eller surfplatta.

I appen kan du hantera *Bluetooth*-anslutningar, hantera inställningar för hörlurarna, välja språk för röstansvisningar och få tillgång till nya funktioner via uppdateringar.

OBS! Om du redan har skapat ett Bose Music-konto för en annan Bose-produkt kan du lägga till hörlurarna till ditt befintliga konto (se längst ner på sida 14).

HÄMTA BOSE MUSIC-APPEN

1. Ladda ner Bose Music-appen till din mobila enhet.

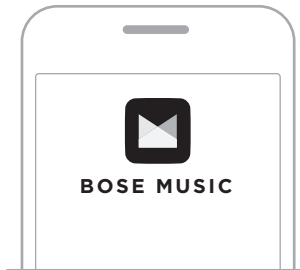

2. Följ instruktionerna för appen.

LÄGGA TILL HÖRLURARNA TILL ETT BEFINTLIGT KONTO

Öppna Bose Music-appen och lägg till dina hörlurar för att lägga till Bose QuietComfort 45.

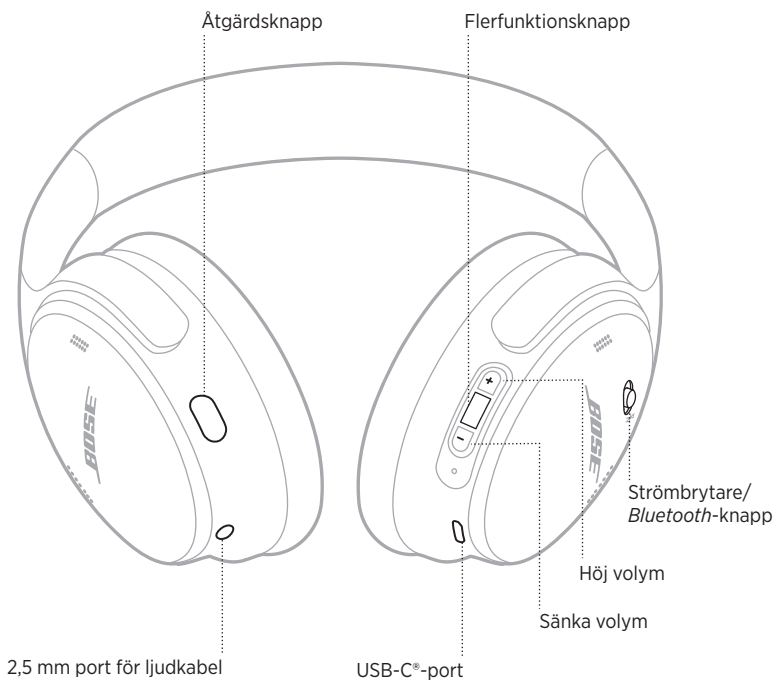

STRÖM PÅ

Skjut strömbrytaren/*Bluetooth*-knappen på höger öronkåpa åt höger.

Du hör en röstansvisning om batteriets laddningsnivå och statuslampan lyser för att visa den aktuella laddningsnivån (se sida 29).



Vilolägesklocka

Timern för viloläget sparar batteri när högtalaren inte används.

Använd Bose Music-appen för att ställa in och anpassa timern för viloläget.

STÄNGA AV

Skjut strömbrytaren/*Bluetooth*-knappen åt vänster.



OBS! Brusreduceringen är inaktiverad när hörlurarna är avstängda.

HÖRLURSFUNKTIONER

Hörlurarnas kontroller finns på baksidan av den högra öronkåpan.

Medieuppspelning och volym

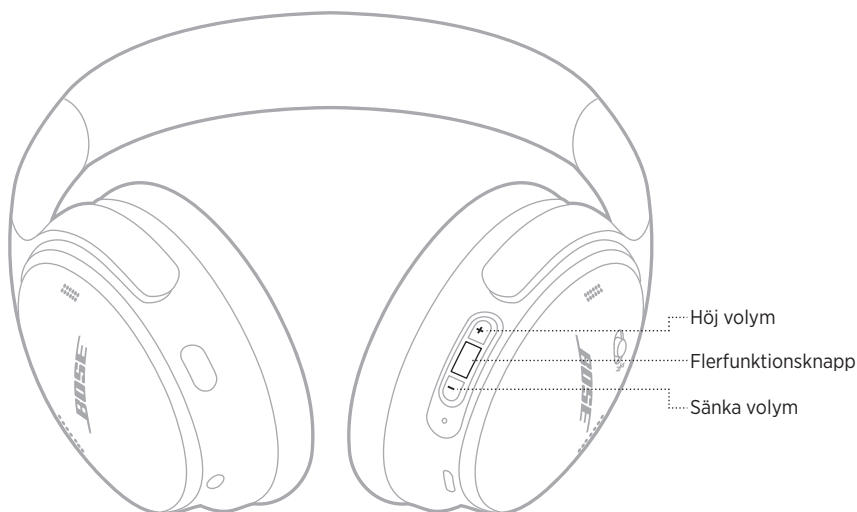

FUNKTION	ÅTGÄRD
Spela/pausa	Tryck på flerfunktionsknappen.
Hoppa framåt	Tryck två gånger på flerfunktionsknappen.
Hoppa bakåt	Tryck tre gånger på flerfunktionsknappen.
Höj volym	Tryck på +.
Sänka volym	Tryck på —.

TÄNK PÅ FÖLJANDE:

- För att höja volymen snabbt trycker du och håller nere +.
- För att sänka volymen snabbt trycker du och håller nere —.

Telefonsamtal

Flerfunktionsknappen finns på baksidan av den högra öronkåpan. Mikrofonen är placerad nära framsidan av höger öronkåpa.

Åtgärdsnappen finns på baksidan av den vänstra öronkåpan.

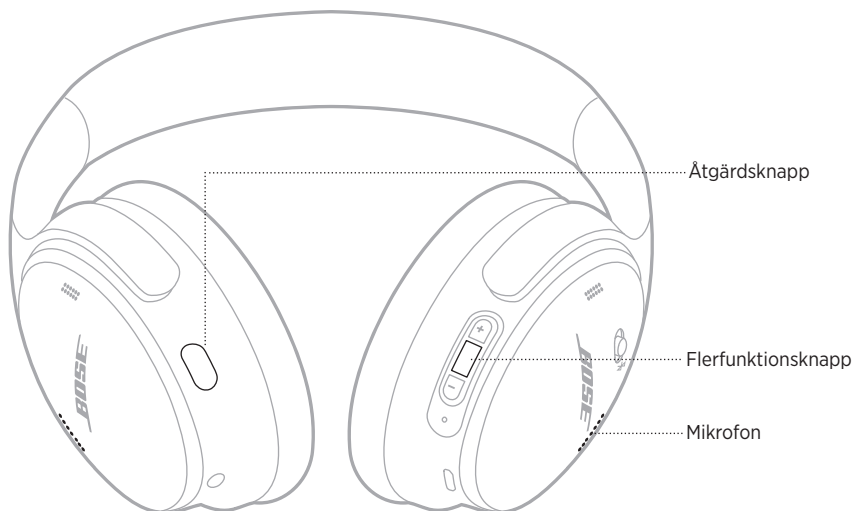

FUNKTION	ÅTGÄRD
Besvara/avsluta ett samtal	Tryck på flerfunktionsknappen.
Avvisa inkommande samtal	Tryck och håll in flerfunktionsknappen i en sekund.
Besvara ytterligare ett samtal och parkera det aktuella.	Tryck på flerfunktionsknappen när ett andra samtal inkommer under ett pågående samtal.
Avvisa ytterligare ett samtal och stanna kvar i det aktuella.	Tryck på och håll inne flerfunktionsknappen i en sekund när ett andra samtal inkommer under ett pågående samtal.
Växla mellan två samtal	Dubbeltryck på flerfunktionsknappen när du har två aktiva samtal.
Skapa en telefonkonferens	Tryck på och håll in flerfunktionsknappen i tre sekunder när du har två aktiva samtal.
Stänga av/sätta på ljudet under ett samtal	Dubbeltryck på åtgärdsnappen under ett samtal.

Åtgärdsknapp

Med åtgärdsknappen kan du snabbt och enkelt växla mellan olika lägen för brusreducering.

Åtgärdsknappen finns på baksidan av den vänstra öronkåpan.

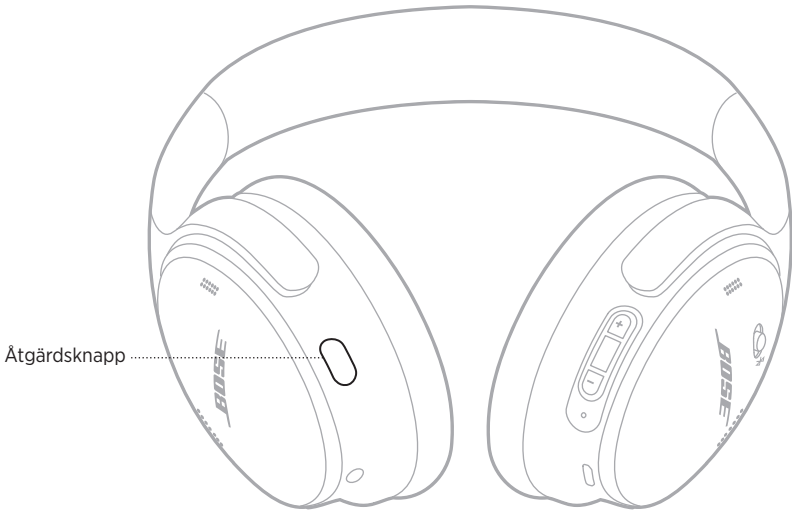

Tryck på åtgärdsknappen för att växla mellan Tyst och Uppmärksam läge.

För mer information om brusreduceringslägen, se sida 21.

Med brusreducering minskas effekten av ej önskvärt ljud vilket ger en tydligare och mer naturtrogen ljudåtergivning. Du kan välja mellan två brusreduceringslägen: Tyst och Uppmärksamt

Tyst läge är den högsta nivån av brusreducering och det blockerar distraktioner.

Uppmärksamt läge ger full transparens så att du hör omgivningen samtidigt som du lyssnar.

Välj brusreduceringsläge utifrån önskemål och omgivning.

BRUSREDUCERINGSLÄGEN

LÄGE	BESKRIVNING
Tyst	Världsledande brusreducering med optimerat ljud från Bose.
Uppmärksamt	Hör omgivningen medan du lyssnar.

OBS! Hörlurarna använder det senast använda läget när de startas.

ÄNDRA LÄGET FÖR BRUSREDUCERING

Tryck på åtgärdsknappen för att byta brusreduceringsläge.

Du hör en röstansvisning angående valt brusreduceringsläge.

TIPS: Du kan även ändra läget för brusreducering via Bose Music-appen.

KOMMA ÅT RÖSTKONTROLLER

Du kan använda hörlurarna för att komma åt röststyrning på mobilenheten. Tryck och håll in flerfunktionsknappen i en sekund för att komma åt röststyrningen.

Flerfunktionsknappen finns på baksidan av den högra öronkåpan.

OBS! Du kan inte aktivera röststyrning medan du är i ett samtal.

ANSLUTA VIA *BLUETOOTH*-MENYN PÅ DEN MOBILA ENHETEN

Hörlurarna kan lagra upp till åtta anslutna enheter i synkroniseringslistan och de kan vara aktivt anslutna till två enheter samtidigt. Du kan endast spela upp ljud från en enhet i taget.

OBS! Få ut maximalt av dina öronsnäckor genom att använda Bose Music-appen för att ställa in och ansluta din mobila enhet (se sida 14).

1. Skjut strömbrytaren/*Bluetooth*-reglaget åt höger  och håll inne i tre sekunder. Du hör "Klar för ihopparning" och statuslampan blinkar med ett blått sken.



2. Aktivera *Bluetooth*-funktionen på din enhet.

OBS! *Bluetooth*-funktionen hittar du vanligtvis i menyn Inställningar.

3. Välj hörlurarna i enhetslistan.

TIPS: Leta efter namnet som du angav för hörlurarna i Bose Music-appen. Om du inte gav hörlurarna något namn kommer standardnamnet att visas.



När enheterna anslutits hör du "Ansluten till <enhetens namn>>" och statuslampan lyser med ett fast blått sken i 10 sekunder.

KOPPLA FRÅN EN MOBIL ENHET

Använd Bose Music-appen för att koppla från din mobila enhet.

TIPS: Du kan även använda appen Bose® Connect för att synkronisera den bärbara enheten. Frånkoppling av *Bluetooth* på din enhet leder till att alla andra enheter kopplas från.

ÅTERANSLUTA EN MOBIL ENHET

När hörlurarna sätts på kommer de automatiskt att försöka återansluta till de två senast anslutna enheterna.

TÄNK PÅ FÖLJANDE:

- Enheten måste vara inom räckvidd (9 m) och påslagna.
- Kontrollera att *Bluetooth* -funktionen är aktiverad på din mobila enhet.

ANSLUTA YTTRELLIGARE EN MOBIL ENHET

För att ansluta ytterligare en enhet ska du ladda ned Bose Music-appen (se sida 14) eller använda *Bluetooth*-menyn på den mobila enheten (se sida 23).

OBS! Du kan endast spela upp ljud från en enhet i taget.

IDENTIFIERA ANSLUTNA MOBILA ENHETER

Skjut strömbrytaren/*Bluetooth*-knappen åt höger ☒ och släpp den sedan för att höra vilken enhet som är ansluten just nu.

VÄXLA MELLAN TVÅ ANSLUTNA MOBILA ENHETER

1. Pausa ljudet i den första bärbara enheten.
2. Spela upp ljudet i den andra mobila enheten.

OBS! Du kan ta emot ett telefonsamtal med hörlurarna från båda enheterna, oavsett vilken enhet som spelar upp ljud.

ÅTERANSLUTA TILL EN TIDIGARE ANSLUTEN ENHET

1. Skjut strömbrytaren/*Bluetooth*-knappen åt höger ⌘ och släpp den sedan för att höra vilken enhet som är ansluten.
2. Skjut inom två sekunder strömbrytaren/*Bluetooth*-knappen ⌘ åt höger och släpp upp igen för att ansluta till nästa enhet i hörlurarnas enhetslista.
3. Upprepa detta tills du hör rätt enhetsnamn.
Du hör en ton som anger när enheten är ansluten.
4. Spela upp ljudet i den anslutna mobila enheten.

OBS! Om två enheter redan är anslutna till hörlurarna kommer den nyligen anslutna enheten att ersätta den andra enheten som anslöts tidigare.

RENSA HÖRLURARNAS ENHETSLISTA

1. Skjut strömbrytaren/*Bluetooth*-knappen till höger ⌘ och håll inne i 15 sekunder tills du hör "*Bluetooth*-enhetslistan rensad. Klar för anslutning."
2. Ta bort hörlurarna från *Bluetooth*-listan på den bärbara enheten.
Alla enheter tas bort och hörlurarna är redo att ansluta.

ANSLUTA LJUDKABELN

Använd 2,5 till 3,5 mm-kabeln för att ansluta en trådbunden enhet till hörlurarna eller för att fortsätta att använda dem även om batteriet är helt urladdat.

1. Anslut kabeln till 2,5 mm-porten på den vänstra kåpan.



2. Anslut den andra änden av kabeln i 3,5 mm-porten på enheten.

OBS! Du kan använda hörlurarna för att komma åt röststyrning på mobilenheten när ljudkabeln är ansluten.

LADDA UPP HÖRLURARNA

1. Anslut den smala änden av USB-kabeln till USB-C-porten i den högra öronkåpan.
2. Anslut den andra änden till en USB-väggsladdare.



TÄNK PÅ FÖLJANDE:

- När hörlurarna börjar ladda blinkar statuslampan i tio sekunder. När de är fulladdade lyser statuslampan med ett fast vitt sken.
- Hörlurarna kan inte användas under uppladdning.

Laddningstid

Det tar cirka två timmar tills hörlurarna är fulladdade.

Höra laddningsnivån

Varje gång som du sätter på hörlurarna hörs en röstansvisning som anger batteriets aktuella laddningsnivå. När hörlurarnas laddningsnivå är låg hörs "Battery low, please charge now" (Batterinivån är låg, ladda nu).

OBS! Titta på statuslampan på den högra öronkåpan om du vill kontrollera batteriladdningen visuellt. Mer information finns på "Batteristatus" på sidan 29.

Statuslampan finns vid höger öronkåpa.



BLUETOOTH-STATUS

Visar *Bluetooth*-anslutningarnas status.

LAMPANS UPPFÖRANDE	SYSTEMLÄGE
Blinkar blått	Klar att anslutas
Fast blått sken (10 sekunder)	Ansluten

BATTERISTATUS

Visar laddningsnivån.

LAMPANS UPPFÖRANDE	SYSTEMLÄGE
Fast vitt sken	Mellan till full laddning
Lyser med fast gult sken	Låg laddning

TIPS: Du kan även kontrollera batterinivån via Bose Music-appen.

LADDNINGSTATUS

Visar laddningsstatus.

LAMPANS UPPFÖRANDE	SYSTEMLÄGE
Blinkar vitt två gånger	Laddningen startar
Lyser med fast gult sken	Laddar
Fast vitt sken	Fulladdat

UPPDATERING OCH FELSTATUS

Visar status för uppdatering eller fel.

LAMPANS UPPFÖRANDE	SYSTEMLÄGE
Blinkar vitt, snabbt (tio sekunder)	Uppdaterar programvaran (via USB)
Blinkar vitt, långsamt (30 till 60 sekunder)	Uppdaterar programvaran (trådlöst)
Blinkar gult och vitt	Fel. Kontakta Bose kundtjänst

ANSLUTA EN BOSE SMART SPEAKER ELLER SOUNDBARHÖGTALARE

Med SimpleSync™-tekniken kan du ansluta hörlurarna till en Bose Smart Soundbar eller Bose Smart Speaker för en personligare lyssning.

Fördelar

- Använd fristående volymkontroller på varje produkt för att sänka eller stänga av ljudet på din Bose Smart Soundbar och samtidigt låta ljudet vara så högt du vill i hörlurarna.
- Hör musiken tydligt från rummet bredvid genom att ansluta hörlurarna till din Bose Smart Speaker.

OBS! SimpleSync™-tekniken har en *Bluetooth*-räckvidd på upp till 9 meter. Väggar och olika byggnadsmaterial kan ibland påverka mottagningen.

Kompatibla produkter

Du kan ansluta hörlurarna till valfri Bose Smart Speaker eller Bose Smart Soundbar.

Populära kompatibla produkter:

- Bose Smart Soundbar 700/Bose Soundbar 700
- Bose Soundbar 500
- Bose Smart Speaker 500/Bose Home Speaker 500
- Bose Home Speaker 300
- Bose Portable Smart Speaker/Bose Portable Home Speaker

Nya produkter läggs till med jämna mellanrum. En fullständig lista och mer information finns på: worldwide.Bose.com/Support/Groups

Ansluta med Bose Music-appen

1. Skjut strömbrytaren/*Bluetooth*-reglaget på hörlurarna åt höger ☒ och håll inne i tre sekunder.

Du hör "Klar för synkronisering med annan enhet" och statuslampan blinkar blått.

2. Använd Bose Music-appen för att ansluta hörlurarna till en kompatibel Bose-produkt. Mer information finns på: worldwide.Bose.com/Support/Groups

TÄNK PÅ FÖLJANDE:

- Kontrollera att hörlurarna är inom 9 m från soundbarhögtalaren eller högtalaren.
- Du kan endast ansluta hörlurarna till en produkt i taget.

ÅTERANSLUTA MED EN BOSE SMART SPEAKER ELLER SOUNDBAR

Sätt på hörlurarna (se "Ström på" på sidan 16).

Hörlurarna försöker ansluta till de två *Bluetooth*-enheter som senast anslöts, inklusive soundbarhögtalare och högtalare.

TÄNK PÅ FÖLJANDE:

- Soundbarhögtalaren eller högtalaren måste vara inom täckningsområdet (9 m) och påsatt.
- Se "Hörlurarna återansluter inte till en tidigare ansluten Bose Smart Soundbar eller högtalare" på sidan 38 om hörlurarna inte återansluts.

FÖRVARA HÖRLURARNA

Vrid öronkåporna för att underlätta förvaring. Placera hörlurarna i fodralet.

1. Vrid båda öronkåporna inåt så att de ligger plant.



2. Vik den vänstra öronkåpan mot huvudbygeln.

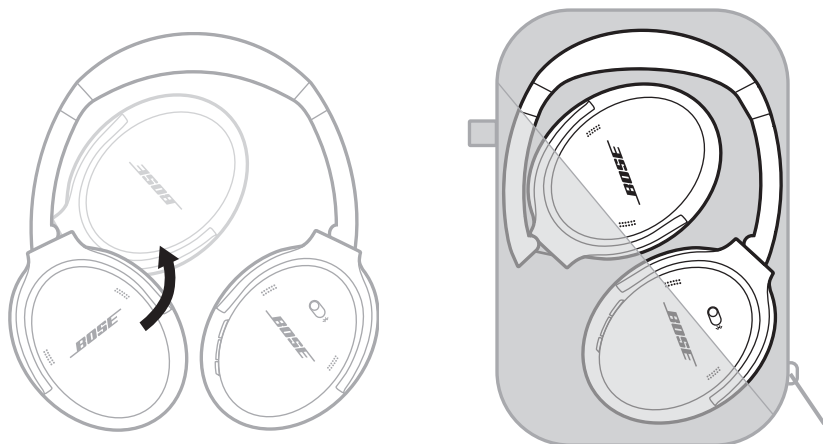

TÄNK PÅ FÖLJANDE:

- Stäng av hörlurarna när du inte använder dem.
- Om du tänker lägga undan hörlurarna i flera månader ska du se till att batteriet är fulladdat.

RENGÖRA HÖRLURARNA

Torka av utsidan med en mjuk, torr trasa.

Se till att det inte kommer in fukt i kåporna.

RESERVDELAR OCH TILLBEHÖR

Reservdelar och tillbehör kan beställas genom Bose kundtjänst.

Besök: support.bose.com/QCSE

BEGRÄNSAD GARANTI

Dina hörlurar omfattas av en begränsad garanti. Mer information om den begränsade garantin finns på worldwide.bose.com/Warranty.

Mer information om hur du registrerar din produkt finns på worldwide.bose.com/ProductRegistration. Dina garantirättigheter påverkas inte om du inte registrerar produkten.

PLATS FÖR SERIENUMMER

Serienumret är placerat på insidan av höger öronkåpa under nätet. Textilduken täcker och skyddar komponenterna i öronkåpan.

Du ser serienumret om du tar tag högst upp och försiktigt lyfter textilduken.

TÄNK PÅ! Tryck inte ned eller ta bort något annat i öronkåpan eftersom du då riskerar att skada hörlurarna.

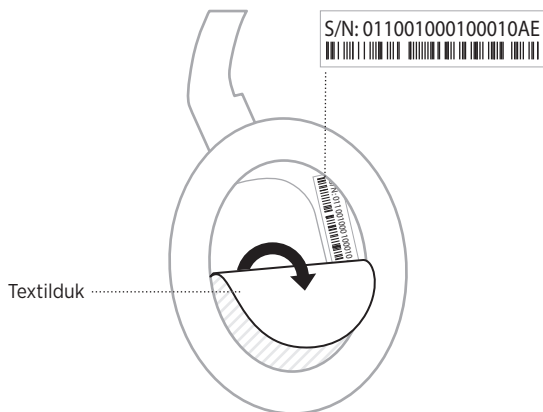

PROVA DET HÄR FÖRST

Om du får problem med hörlurarna:

- Kontrollera statuslampans tillstånd (se sida 29).
- Ladda batteriet (se sida 28).
- Öka volymen i hörlurarna, på den mobila enheten och i musikappen.
- Ladda ned Bose Music-appen och kör tillgängliga programuppdateringar (se sida 14).
- Prova med att ansluta en annan mobil enhet (se sida 25)

Om du inte kan lösa problemet ska du titta i tabellen nedan för att identifiera symptom och ta del av lösningar till vanliga problem. Kontakta Boses kundtjänst om du inte kan lösa ditt problem.

Besök: worldwide.Bose.com/contact

ANDRA LÖSNINGAR

SYMPTOM	LÖSNING
Hörlurarna sätts inte på	Ladda batteriet.
Hörlurarna ansluter inte till den mobila enheten	<p>Dra ur den extra medföljande ljudkabeln.</p> <p>Dra ur USB-laddningskabeln.</p> <p>På den mobila enheten:</p> <p>Inaktivera <i>Bluetooth</i>-funktionen och aktivera den sedan på nytt.</p> <p>Ta bort Bose QuietComfort 45-hörlurarna från <i>Bluetooth</i>-listan på enheten, inklusive dubletter etiketterade med LE (Low Energy). Anslut en gång till.</p> <p>Flytta den mobila enheten närmare hörlurarna och längre bort från eventuella störningskällor eller hinder.</p> <p>Gå till support.Bose.com/QCSE om du vill se instruktionsfilmer.</p> <p>Rensa listan med anslutna enheter (se sida 26) och anslut igen.</p>
Batteriet laddar inte	<p>Kontrollera ändarna på USB-laddningskabeln.</p> <p>Prova med en annan laddningskälla.</p> <p>Om hörlurarna har utsatts för höga eller låga temperaturer, ska du låta dem återfå rumstemperatur och sedan prova med att ladda upp dem igen.</p>

SYMPTOM	LÖSNING
Inget ljud	<p>Sätt på hörlurarna och ladda batteriet.</p> <p>Kontrollera statuslampans tillstånd (se sida 29).</p> <p>Skjut strömbrytaren/<i>Bluetooth</i>-knappen åt höger och släpp för att höra den anslutna enheten. Kontrollera att du använder en kompatibel enhet.</p> <p>Flytta den mobila enheten närmare hörlurarna och längre bort från eventuella störningskällor eller hinder.</p> <p>Försök med en annan musikkälla.</p> <p>Om två mobila enheter är anslutna ska du först pausa den andra enheten.</p> <p>Om två mobila enheter är anslutna, ska du flytta enheterna inom hörlurarnas täckningsområde (9 m).</p> <p>Testa en lokalt lagrad musik- eller videofil på din mobila enhet.</p>
Dålig ljudkvalitet	<p>Försök med en annan musikkälla.</p> <p>Ansluta en annan mobil enhet (se sida 25).</p> <p>Koppla bort den andra enheten.</p> <p>Flytta den mobila enheten närmare hörlurarna och längre bort från eventuella störningskällor eller hinder.</p> <p>Testa en lokalt lagrad musik- eller videofil på din mobila enhet.</p>
Inget ljud från en enhet som är ansluten via ljudkabeln	<p>Kontrollera ändarna på den extra medföljande ljudkabeln.</p> <p>Öka volymen i hörlurarna, den mobila enheten och musikkällan.</p> <p>Anslut en annan enhet (se sida 25).</p>
Dålig ljudkvalitet hörs från en enhet som är ansluten med ljudkabeln	<p>Kontrollera ändarna på den extra medföljande ljudkabeln.</p> <p>Anslut en annan enhet (se sida 25).</p>
Det går inte att ändra brusreduceringsläge med åtgärdsknappen.	<p>Kontrollera att båda hörlurarna är påslagna.</p> <p>Använd appen Bose Music för att ändra brusreduceringsläge.</p>

SYMPTOM	LÖSNING
Hörlurarna ansluter inte till en Bose Smart Soundbar eller högtalare	Dra och håll ner <i>Bluetooth</i> [®] -knappen tills du hör "Klar för synkronisering" eller <i>Bluetooth</i> -indikatorerna på båda öronpropparna blinkar med blått sken. Kontrollera att hörlurarna är inom 9 m från soundbarhögtalaren eller högtalaren.
Hörlurarna återansluter inte till en tidigare ansluten Bose Smart Soundbar eller högtalare	Återanslut till en tidigare ansluten enhet (se sida 26)
Ljutfördröjningar vid anslutning till en Bose Smart Soundbar eller högtalare	Ladda ner Bose Music-appen och alla uppdateringar.

En fabriksåterställning kan rensa alla inställningar och återställa hörlurarna till tiollståndet du fick dem i. Efteråt kan hörlurarna ställas in som om det görs för första gången.

En fabriksåterställning rekommenderas endast om du har problem med hörlurarna eller om du instruerats av Boses kundtjänst att göra det.

ÅTERSTÄLLA HÖRLURARNA TILL FABRIKSINSTÄLLNINGARNA

1. Ta bort hörlurarna från *Bluetooth*-listan på din mobila enhet.
2. Ta bort hörlurarna från Bose-kontot med Bose Music-appen.

OBS! Mer information om hur du tar bort hörlurarna från Bose-kontot med Bose Music-appen finns på: support.bose.com/QCSE

3. Skjut strömbrytaren/*Bluetooth*-reglaget åt höger \times och håll inne. Tryck samtidigt och håll nere åtgärdsknappen i 30 sekunder.

Statuslampan blinkar vitt. Efter 30 sekunder blinkar statuslampan gult för att ange att fabriksinställningarna återställs (i 2 till 3 sekunder).

4. När återställningen slutförts kommer statuslampan att blinka långsamt med ett blått sken. Hörlurarna är nu fabriksåterställda.

โปรดอ่านและเก็บคำแนะนำด้านความปลอดภัย การรักษาความปลอดภัย และการใช้งานทั้งหมดไว้



Bose Corporation ขอประกาศในที่นี้ว่าผลิตภัณฑ์นี้สอดคล้องตามข้อกำหนดที่จำเป็นและข้อบังคับที่เกี่ยวข้องอื่นๆ ของข้อกำหนดกับ Directive 2014/53/EU และข้อบังคับอื่นๆ ทั้งหมดของข้อกำหนดกับ EU ที่ใช้บังคับ ในรับรองมาตรฐานความปลอดภัยของผลิตภัณฑ์ฉบับสมบูรณ์ สามารถอ่านได้จาก www.Bose.com/compliance



ผลิตภัณฑ์นี้สอดคล้องตามข้อกำหนดความเข้ากันได้ทางแม่เหล็กไฟฟ้า 2016 ที่เกี่ยวข้องทั้งหมดและข้อกำหนด UK ที่เกี่ยวข้องทั้งหมดอื่นๆ ในรับรองมาตรฐานความปลอดภัยของผลิตภัณฑ์ฉบับสมบูรณ์ สามารถอ่านได้จาก www.Bose.com/compliance

Bose Corporation ขอประกาศในที่นี้ว่าผลิตภัณฑ์นี้สอดคล้องตามข้อกำหนดที่จำเป็นของกฎระเบียบว่าด้วยอุปกรณ์วิทยุ 2017 และข้อกำหนด UK ที่เกี่ยวข้องทั้งหมดอื่นๆ ในรับรองมาตรฐานความปลอดภัยของผลิตภัณฑ์ฉบับสมบูรณ์ สามารถอ่านได้จาก www.Bose.com/compliance

คำแนะนำด้านความปลอดภัยที่สำคัญ

อย่าใช้อุปกรณ์นี้ใกล้กับน้ำ

ทำความสะอาดด้วยผ้าแห้งเท่านั้น

นำผลิตภัณฑ์เข้ารับการซ่อมแซมทั้งหมดจากช่างผู้ชำนาญเท่านั้น การเข้ารับบริการซ่อมแซมเป็นสิ่งจำเป็นเมื่ออุปกรณ์เกิดความเสียหายไม่ว่าทางใดทางหนึ่ง เช่น สายไฟหรือปลั๊กเสียหาย ของเหลวหรือวัตถุหรือวัสดุแปลกปลอมตกหล่นเข้าไปในอุปกรณ์ อุปกรณ์ถูกฝนหรือความชื้น ไม่ทำงานตามปกติ หรืออุปกรณ์ดกหล่น

คำเตือน/ข้อควรระวัง

- อย่าใช้หูฟังที่ระดับเสียงดังมากเป็นระยะเวลานาน
 - เพื่อหลีกเลี่ยงปัญหาการได้ยินบกพร่อง ใช้หูฟังของคุณในระดับเสียงปานกลางและเหมาะสม
 - ลดระดับเสียงบนอุปกรณ์ของคุณลงก่อนเสียบหูฟังที่หูของคุณ จากนั้น เพิ่มระดับเสียงที่ละนิดจนกระทั่งคุณได้ยินระดับเสียงที่พอเหมาะสำหรับการฟัง
- อย่าใช้หูฟังของคุณในระหว่างการขับขี่เพื่อโทรศัพท์หรือจุดประสงค์อื่น
- อย่าใช้หูฟังเปิดโดยปิดโหมดการตัดเสียงรบกวนในเวลาใดก็ตามที่คุณไม่สามารถได้ยินเสียงรอบข้างอาจเป็นอันตรายต่อตัวคุณเองหรือผู้อื่น เช่น ขณะขี่จักรยานหรือเดินบนถนนหรือใกล้กับทางจราจร สถานที่ก่อสร้าง หรือทางรถไฟ ฯลฯ และปฏิบัติตามกฎหมายที่ใช้บังคับเกี่ยวกับการใช้หูฟัง
 - ปิดหูฟัง หรือใช้หูฟังโดยปิดโหมดการตัดเสียงรบกวน และปรับระดับเสียงของคุณ เพื่อให้แน่ใจว่าคุณสามารถได้ยินเสียงรอบข้างได้ รวมถึงเสียงเตือนหรือสัญญาณเตือนต่างๆ
 - โปรดทราบว่าเสียงที่คุณใช้เป็นเสียงเตือนความจำหรือเสียงเตือนอาจมีเสียงที่แตกต่างไปเมื่อคุณสวมหูฟังอยู่ แม้เมื่ออยู่ในโหมดรับรู้
- อย่าใช้หูฟัง หากมีเสียงรบกวนดังผิดปกติเกิดขึ้น หากเหตุการณ์นี้เกิดขึ้น ปิดหูฟัง และติดต่อฝ่ายบริการลูกค้าของ Bose
- ถอดหูฟังออกทันทีหากคุณรู้สึกถึงความร้อน หรือสัญญาณเสียงขาดหายไป
- ไม่ใช่ข้อแนะนำโทรศัพท์มือถือเพื่อเชื่อมต่อหูฟังเข้ากับช่องเสียบ ณ ที่นั่งบนเครื่องบิน เพราะอาจทำให้เกิดอาการบาดเจ็บหรืออุปกรณ์เสียหายเนื่องจากความรบกวน
- อย่าใช้หูฟังเป็นหูฟังที่ใช้ในการสื่อสารในการบิน



ผลิตภัณฑ์นี้ประกอบด้วยชิ้นส่วนขนาดเล็ก ซึ่งอาจทำให้เกิดอันตรายจากการสำลัก ไม่เหมาะสำหรับเด็กอายุต่ำกว่า 3 ปี



ผลิตภัณฑ์นี้ประกอบด้วยวัสดุแม่เหล็ก ปรีกษาแพทย์ว่าสิ่งนี้อาจส่งผลต่อการใช้งานอุปกรณ์การแพทย์ที่ปลูกถ่ายของคุณหรือไม่

- เพื่อลดความเสี่ยงต่อการเกิดเพลิงไหม้หรือไฟฟ้าดูด อย่าให้ผลิตภัณฑ์นี้ถูกฝน น้ำหยด น้ำกระเซ็น หรือความชื้น และไม่ควรวางภาชนะบรรจุของเหลว เช่น แจกัน ไวน์หรือโถกับเครื่อง
- วางผลิตภัณฑ์ให้อยู่ห่างจากไฟและแหล่งที่ก่อให้เกิดความร้อน อย่าวางสิ่งแปลกๆ ใหม่ใดๆ เช่น เทียนไขที่จุดไฟ ไวน์หรือโถกับผลิตภัณฑ์
- ใช้กับแหล่งจ่ายไฟ LPS ที่ได้รับการอนุมัติจากหน่วยงานที่สอดคล้องตามข้อกำหนดของท้องถิ่น (เช่น UL, CSA, VDE, CCC) เท่านั้น
- อย่าตัดแปลงผลิตภัณฑ์นี้โดยไม่ได้รับอนุญาต
- หากเบตเตอร์ีเกิดมีของเหลวรั่วซึม อย่าให้ของเหลวนั้นสัมผัสกับผิวหนังหรือเข้าตาคุณ หากสัมผัส โปรดพบแพทย์
- อย่าให้ผลิตภัณฑ์ที่มีเบตเตอร์ีถูกความร้อนสูงเกินไป (เช่น จัดเก็บในที่ที่ถูกแสงแดดจัด ไฟ หรืออื่นๆ คล้ายกันนี้)
- อย่าสวมหูฟังขณะชาร์จ

หมายเหตุ: อุปกรณ์นี้ผ่านการทดสอบและพบว่าตรงตามข้อกำหนดสำหรับอุปกรณ์ดีจิตอล คลาส B ตามส่วน 15 ของระเบียบ FCC ข้อกำหนดนี้กำหนดขึ้นเพื่อให้การป้องกันที่เหมาะสมจากการรบกวนที่เป็นอันตรายในการติดตั้งในที่พักอาศัย อุปกรณ์นี้ก่อให้เกิด ไข้ และสามารถแผ่พลังงานความถี่วิทยุ และหากติดตั้งและใช้งานไม่ตรงตามคำแนะนำ อาจเป็นสาเหตุให้เกิดการรบกวนที่เป็นอันตรายกับการสื่อสารทางวิทยุ อย่างไรก็ตาม ไม่มีการรับประกันว่าการรบกวนนี้จะไม่เกิดขึ้นในการติดตั้งแบบใดแบบหนึ่ง หากอุปกรณ์นี้ก่อให้เกิดการรบกวนที่เป็นอันตรายกับการรับสัญญาณวิทยุหรือโทรทัศน์ ซึ่งสามารถพิจารณาได้จากการลองปิดและเปิดอุปกรณ์ ขอแนะนำให้ผู้ใช้งานแก้ไขการรบกวนดังกล่าว ด้วยวิธีการต่อไปนี้

- เปลี่ยนทิศทางหรือตำแหน่งของผลิตภัณฑ์รับสัญญาณหรือเสาอากาศ
- เพิ่มระยะห่างระหว่างอุปกรณ์และเครื่องรับสัญญาณ
- เสียบปลั๊กอุปกรณ์นี้กับตัวรับไฟฟ้าที่ไม่ได้ใช้ส่วร่วมกับเครื่องรับสัญญาณ
- ติดต่อขอรับความช่วยเหลือจากตัวแทนจำหน่ายหรือช่างเทคนิคด้านวิทยุ/โทรทัศน์ที่มีประสบการณ์

การแก้ไขหรือตัดแปลงอื่นใดที่ไม่ได้รับอนุญาตโดยตรงจาก Bose Corporation อาจทำให้ผู้ใช้ไม่มีสิทธิ์ใช้งานอุปกรณ์นี้อีกต่อไป อุปกรณ์นี้สอดคล้องตามส่วน 15 ของระเบียบ FCC และมาตรฐาน RSS ที่ได้รับการยกเว้นใบอนุญาต ISED Canada การทำงานของอุปกรณ์นี้ขึ้นอยู่กับเงื่อนไข 2 ประการ ดังนี้ (1) อุปกรณ์นี้ต้องไม่ก่อให้เกิดสัญญาณรบกวนที่เป็นอันตราย และ (2) อุปกรณ์นี้ต้องยอมรับสัญญาณรบกวนทุกชนิดที่ได้รับ รวมถึงสัญญาณรบกวนที่อาจทำให้เกิดการทำงานที่ไม่พึงประสงค์

อุปกรณ์นี้สอดคล้องตามข้อกำหนดความเสี่ยงต่ออันตรายจากรังสีของ FCC และ ISED Canada ตามที่ประกาศไว้สำหรับประชาชนทั่วไป ต้องไม่ใช้งานหรือตั้งเครื่องส่งร่วมกับเสาอากาศหรือเครื่องส่งสัญญาณอื่นใด

ปฏิบัติตามข้อกำหนด IMDA

FCC ID: A94437310

IC: 3232A-437310

CAN ICES-3(B)/NMB-3(B)

สำหรับยุโรป:

ช่วงความถี่การทำงานคือ 2400 ถึง 2483.5 MHz

กำลังการส่งสูงสุดน้อยกว่า 20 dBm EIRP

กำลังการส่งสูงสุดต่ำกว่าข้อกำหนดที่กำหนด ดังนั้นไม่จำเป็นต้องมีการทดสอบ SAR และยกเว้นตามข้อกำหนดที่เกี่ยวข้อง



สัญลักษณ์นี้หมายความว่าไม่ควรทิ้งผลิตภัณฑ์นี้เหมือนเป็นขยะตามบ้านทั่วไป และควรจัดการทิ้งให้กับสถานจัดเก็บขยะที่เหมาะสมเพื่อการนำไปรีไซเคิล การจัดการทิ้งและการรีไซเคิลที่เหมาะสมช่วยปกป้องทรัพยากรธรรมชาติ สุขภาพของมนุษย์ และสิ่งแวดล้อม สำหรับข้อมูลเพิ่มเติมเกี่ยวกับการทิ้งและการรีไซเคิลผลิตภัณฑ์นี้ ให้ติดต่อเทศบาลในท้องถิ่นของคุณ บริการกำจัดขยะ หรือร้านค้าที่คุณซื้อผลิตภัณฑ์นี้

ข้อกำหนดทางด้านเทคนิคของอุปกรณ์ความถี่วิทยุกำลังต่ำ

บริษัท กิจการ หรือผู้ใช้ไม่ได้รับอนุญาตให้เปลี่ยนความถี่ ปรับปรุงกำลังการส่งสัญญาณ หรือแก้ไขลักษณะเฉพาะตลอดจนถึงประสิทธิภาพดั้งเดิมของอุปกรณ์ความถี่วิทยุกำลังต่ำที่ได้รับอนุมัติ หากไม่ได้รับอนุญาตจาก NCC อุปกรณ์ความถี่วิทยุกำลังต่ำไม่ควรมีผลต่อความปลอดภัยของเครื่องบิน และรบกวนการสื่อสารตามกฎหมาย หากไม่เป็นเช่นนั้น ผู้ใช้ควรยุติการใช้งานทันทีจนกว่าจะไม่มีสัญญาณรบกวนอีกต่อไป การสื่อสารตามกฎหมายที่กล่าวข้างต้นหมายถึงการสื่อสารทางวิทยุที่ดำเนินการสอดคล้องกับกฎหมายการจัดการโทรคมนาคม อุปกรณ์ความถี่วิทยุกำลังต่ำต้องยอมรับการรบกวนจากระบบการสื่อสารตามกฎหมายหรืออุปกรณ์ที่ปล่อยคลื่นวิทยุ ISM

อย่าพยายามถอดแบตเตอรี่ลิเทียมไอออนแบบชาร์จได้ออกจากผลิตภัณฑ์นี้ ในกรณีที่ต้องการถอดแบตเตอรี่ดังกล่าวออก โปรดติดต่อร้านค้าปลีกของ Bose ในท้องถิ่นของคุณหรือผู้จำหน่ายรายอื่น ๆ

การถอดแบตเตอรี่ลิเทียมไอออนชนิดชาร์จซ้ำได้ในผลิตภัณฑ์นี้ควรดำเนินการโดยผู้จำหน่ายการเท่านั้น โปรดติดต่อร้านค้าปลีกของ Bose ในท้องถิ่นของคุณ หรือดูที่ products.bose.com/static/compliance/index.html สำหรับข้อมูลเพิ่มเติม



โปรดทิ้งแบตเตอรี่ที่ใช้แล้วให้เหมาะสม ตามระเบียบข้อบังคับของท้องถิ่น อย่าเผาแบตเตอรี่



ชื่อและปริมาณสารหรือองค์ประกอบที่เป็นพิษหรือเป็นอันตราย						
ชื่อชิ้นส่วน	สารและองค์ประกอบที่เป็นพิษหรือเป็นอันตราย					
	ตะกั่ว (Pb)	ปรอท (Hg)	แคดเมียม (Cd)	โครเมียม 6 (CR(VI))	โพลีโบรมิเนเตดไบเฟนิล (PBB)	โพลีโบรมิเนเตดไดเฟนิลอีเธอร์ (PBDE)
PCB	X	0	0	0	0	0
ชิ้นส่วนโลหะ	X	0	0	0	0	0
ชิ้นส่วนพลาสติก	0	0	0	0	0	0
ลำโพง	X	0	0	0	0	0
สาย	X	0	0	0	0	0
ตารางนี้ได้รับการจัดเตรียมตามข้อกำหนดของ SJ/T 11364 O: หมายความว่าสารพิษหรือสารอันตรายที่อยู่ในวัสดุทั้งหมดที่เป็นเนื้อเดียวกันสำหรับชิ้นส่วนนี้มีปริมาณต่ำกว่าข้อกำหนดขีดจำกัดของ GB/T 26572 X: หมายความว่าสารพิษหรือสารอันตรายที่อยู่ในวัสดุที่เป็นเนื้อเดียวกันอย่างน้อยหนึ่งชิ้นที่ใช้สำหรับชิ้นส่วนนี้มีปริมาณสูงกว่าข้อกำหนดขีดจำกัดของ GB/T 26572						

วันที่ผลิต: ตัวเลขหลักที่ 8 ในหมายเลขซีเรียลระบุถึงปีที่ผลิต หมายเลข "2" หมายถึงปี ค.ศ. 2012 หรือปี ค.ศ. 2022

ผู้นำเข้าของจีน: Bose Electronics (Shanghai) Company Limited, Level 6, Tower D, No. 2337 Gudai Rd. Minhang District, Shanghai 201100

ผู้นำเข้าของ EU: Bose Products B.V., Gorslaan 60, 1441 RG Purmerend, The Netherlands

ผู้นำเข้าของเม็กซิโก: Bose de México S. de R.L. de C.V., Avenida Prado Sur #150, Piso 2, Interior 222 y 223, Colonia Lomas de Chapultepec V Sección, Miguel Hidalgo, Ciudad de México, C.P. 11000 หมายเลขโทรศัพท์: +5255 (5202) 3545

ผู้นำเข้าของไต้หวัน: Bose Limited Taiwan Branch (H.K.), 9F, No. 10, Sec. 3, Minsheng E. Road, Zhongshan Dist. Taipei City 10480, หมายเลขโทรศัพท์ของไต้หวัน: +886-2-2514 7676

ผู้นำเข้าของ UK: Bose Limited, Bose House, Quayside Chatham Maritime, Chatham, Kent, ME4 4QZ, United Kingdom
 พิกัดกำลังไฟขาเข้า: 5V --- 0.5A

ช่วงอุณหภูมิขณะชาร์จ: 0°C ถึง 45°C (32°F ถึง 113°F)

ช่วงอุณหภูมิขณะคายประจุ: -20° C ถึง 60° C (-4° F ถึง 140° F)

รุ่น 437310 CMIIT ID อยู่ในส่วนครอบหูได้วัสดุ

โปรดกรอกข้อมูลและเก็บไว้เป็นบันทึกของคุณ

หมายเลขซีเรียลและหมายเลขรุ่นจะอยู่ในส่วนครอบหูได้วัสดุ

หมายเลขซีเรียล: _____

หมายเลขรุ่น: _____

โปรดเก็บใบเสร็จรับเงินไว้กับคู่มือผู้ใช้ ในตอนนี้ คุณควรลงทะเบียนผลิตภัณฑ์ Bose ของคุณ คุณสามารถดำเนินการได้อย่างง่ายดายโดยไปที่ worldwide.Bose.com/ProductRegistration

ข้อมูลด้านความปลอดภัย



ผลิตภัณฑ์ที่สามารถรับอัปเดตความปลอดภัยจาก Bose โดยอัตโนมัติเมื่อเชื่อมต่อกับแอปพลิเคชัน Bose Music หากต้องการรับอัปเดตความปลอดภัยผ่านทางแอปพลิเคชันเคลื่อนที่ คุณต้องดำเนินการขั้นตอนการตั้งค่าผลิตภัณฑ์ในแอปพลิเคชัน Bose Music ให้เสร็จสมบูรณ์ หากคุณไม่ได้ดำเนินการขั้นตอนการตั้งค่าจนเสร็จสมบูรณ์ คุณจะต้องรับผิดชอบในการติดตั้งอัปเดตความปลอดภัยที่ Bose มีให้ใช้งานทาง btu.bose.com

Apple, โลโก้ Apple, iPad, iPhone และ iPod เป็นเครื่องหมายการค้าของ Apple Inc. ที่จดทะเบียนในสหรัฐฯ และประเทศอื่นๆ App Store เป็นเครื่องหมายบริการของ Apple Inc. เครื่องหมายการค้า “iPhone” ใช้ในญี่ปุ่นโดยได้รับสิทธิการใช้งานจาก Aiphone K.K.

การใช้เครื่องหมาย Made for Apple หมายความว่าอุปกรณ์เสริมนั้นๆ ได้รับการออกแบบมาเพื่อเชื่อมต่อกับอุปกรณ์ Apple ที่ระบุในเครื่องหมายนั้นโดยเฉพาะ และได้รับการรับรองจากผู้พัฒนาว่าตรงตามมาตรฐานประสิทธิภาพของ Apple Apple ไม่รับผิดชอบต่อการทำงานของอุปกรณ์นี้หรือความสอดคล้องกับมาตรฐานความปลอดภัยและระเบียบข้อบังคับของอุปกรณ์

ข้อความแสดงชื่อและโลโก้ *Bluetooth*® เป็นเครื่องหมายการค้าจดทะเบียนของ Bluetooth SIG, Inc. และการใช้เครื่องหมายเหล่านั้นโดย Bose Corporation อยู่ภายใต้การอนุญาต

Google Play เป็นเครื่องหมายการค้าของ Google LLC

USB Type-C® และ USB-C® เป็นเครื่องหมายการค้าจดทะเบียนของ USB Implementers Forum

Bose, Bose Home Speaker, Bose Music, โลโก้ Bose Music, Bose Smart Soundbar, Bose Smart Speaker, Bose Soundbar, QuietComfort และ SimpleSync เป็นเครื่องหมายการค้าของ Bose Corporation

สำนักงานใหญ่ Bose Corporation: 1-877-230-5639

©2022 Bose Corporation ห้ามทำซ้ำ แก้ไข เผยแพร่ ส่วนหนึ่งส่วนใดของเอกสารนี้ หรือนำไปใช้งานใดๆ โดยไม่ได้รับอนุญาต เป็นลายลักษณ์อักษร

The following license disclosures apply to certain third-party software packages used as components in the product.

Package: FreeRTOS

Copyright © Amazon Web Services, Inc. or its affiliates. All rights reserved.

The FreeRTOS package is subject to the license terms reprinted below:

MIT License

Permission is hereby granted, free of charge, to any person obtaining a copy of this software and associated documentation files (the “Software”), to deal in the Software without restriction, including without limitation the rights to use, copy, modify, merge, publish, distribute, sublicense, and/or sell copies of the Software, and to permit persons to whom the Software is furnished to do so, subject to the following conditions:

The above copyright notice and this permission notice shall be included in all copies or substantial portions of the Software.

THE SOFTWARE IS PROVIDED “AS IS”, WITHOUT WARRANTY OF ANY KIND, EXPRESS OR IMPLIED, INCLUDING BUT NOT LIMITED TO THE WARRANTIES OF MERCHANTABILITY, FITNESS FOR A PARTICULAR PURPOSE AND NONINFRINGEMENT. IN NO EVENT SHALL THE AUTHORS OR COPYRIGHT HOLDERS BE LIABLE FOR ANY CLAIM, DAMAGES OR OTHER LIABILITY, WHETHER IN AN ACTION OF CONTRACT, TORT OR OTHERWISE, ARISING FROM, OUT OF OR IN CONNECTION WITH THE SOFTWARE OR THE USE OR OTHER DEALINGS IN THE SOFTWARE.

Package: Nanopb

Copyright © 2011 Petteri Aimonen <jpa at nanopb.mail.kapsi.fi>.

The Nanopb package is subject to the license terms reprinted below:

Zlib License

© 2011 Petteri Aimonen <jpa at nanopb.mail.kapsi.fi>

This software is provided ‘as-is’, without any express or implied warranty. In no event will the authors be held liable for any damages arising from the use of this software.

Permission is granted to anyone to use this software for any purpose, including commercial applications, and to alter it and redistribute it freely, subject to the following restrictions:

1. The origin of this software must not be misrepresented; you must not claim that you wrote the original software. If you use this software in a product, an acknowledgment in the product documentation would be appreciated but is not required.
2. Altered source versions must be plainly marked as such, and must not be misrepresented as being the original software.
3. This notice may not be removed or altered from any source distribution.

Package: Mbed TLS 2.16.1

© ARM Limited. All rights reserved.

The Mbed TLS package is subject to the license terms reprinted below:

Apache License

Version 2.0, January 2004

<http://www.apache.org/licenses/>

TERMS AND CONDITIONS FOR USE, REPRODUCTION, AND DISTRIBUTION

1. Definitions.
“License” shall mean the terms and conditions for use, reproduction, and distribution as defined by Sections 1 through 9 of this document.

“Licensor” shall mean the copyright owner or entity authorized by the copyright owner that is granting the License.

“Legal Entity” shall mean the union of the acting entity and all other entities that control, are controlled by, or are under common control with that entity. For the purposes of this definition, “control” means (i) the power, direct or indirect, to cause the direction or management of such entity, whether by contract or otherwise, or (ii) ownership of fifty percent (50%) or more of the outstanding shares, or (iii) beneficial ownership of such entity.

“You” (or “Your”) shall mean an individual or Legal Entity exercising permissions granted by this License.

“Source” form shall mean the preferred form for making modifications, including but not limited to software source code, documentation source, and configuration files.

“Object” form shall mean any form resulting from mechanical transformation or translation of a Source form, including but not limited to compiled object code, generated documentation, and conversions to other media types.

“Work” shall mean the work of authorship, whether in Source or Object form, made available under the License, as indicated by a copyright notice that is included in or attached to the work (an example is provided in the Appendix below).

“Derivative Works” shall mean any work, whether in Source or Object form, that is based on (or derived from) the Work and for which the editorial revisions, annotations, elaborations, or other modifications represent, as a whole, an original work of authorship. For the purposes of this License, Derivative Works shall not include works that remain separable from, or merely link (or bind by name) to the interfaces of, the Work and Derivative Works thereof.

“Contribution” shall mean any work of authorship, including the original version of the Work and any modifications or additions to that Work or Derivative Works thereof, that is intentionally submitted to Licensor for inclusion in the Work by the copyright owner or by an individual or Legal Entity authorized to submit on behalf of the copyright owner. For the purposes of this definition, “submitted” means any form of electronic, verbal, or written communication sent to the Licensor or its representatives, including but not limited to communication on electronic mailing lists, source code control systems, and issue tracking systems that are managed by, or on behalf of, the Licensor for the purpose of discussing and improving the Work, but excluding communication that is conspicuously marked or otherwise designated in writing by the copyright owner as “Not a Contribution.”

“Contributor” shall mean Licensor and any individual or Legal Entity on behalf of whom a Contribution has been received by Licensor and subsequently incorporated within the Work.

2. Grant of Copyright License. Subject to the terms and conditions of this License, each Contributor hereby grants to You a perpetual, worldwide, non-exclusive, no-charge, royalty-free, irrevocable copyright license to reproduce, prepare Derivative Works of, publicly display, publicly perform, sublicense, and distribute the Work and such Derivative Works in Source or Object form.
3. Grant of Patent License. Subject to the terms and conditions of this License, each Contributor hereby grants to You a perpetual, worldwide, non-exclusive, no-charge, royalty-free, irrevocable (except as stated in this section) patent license to make, have made, use, offer to sell, sell, import, and otherwise transfer the Work, where such license applies only to those patent claims licensable by such Contributor that are necessarily infringed by their Contribution(s) alone or by combination of their Contribution(s) with the Work to which such Contribution(s) was submitted. If You institute patent litigation against any entity (including a cross-claim or counterclaim in a lawsuit) alleging that the Work or a Contribution incorporated within the Work constitutes direct or contributory patent infringement, then any patent licenses granted to You under this License for that Work shall terminate as of the date such litigation is filed.
4. Redistribution. You may reproduce and distribute copies of the Work or Derivative Works thereof in any medium, with or without modifications, and in Source or Object form, provided that You meet the following conditions:
 - a. You must give any other recipients of the Work or Derivative Works a copy of this License; and
 - b. You must cause any modified files to carry prominent notices stating that You changed the files; and
 - c. You must retain, in the Source form of any Derivative Works that You distribute, all copyright, patent, trademark, and attribution notices from the Source form of the Work, excluding those notices that do not pertain to any part of the Derivative Works; and

d. If the Work includes a “NOTICE” text file as part of its distribution, then any Derivative Works that You distribute must include a readable copy of the attribution notices contained within such NOTICE file, excluding those notices that do not pertain to any part of the Derivative Works, in at least one of the following places: within a NOTICE text file distributed as part of the Derivative Works; within the Source form or documentation, if provided along with the Derivative Works; or, within a display generated by the Derivative Works, if and wherever such third-party notices normally appear. The contents of the NOTICE file are for informational purposes only and do not modify the License. You may add Your own attribution notices within Derivative Works that You distribute, alongside or as an addendum to the NOTICE text from the Work, provided that such additional attribution notices cannot be construed as modifying the License.

You may add Your own copyright statement to Your modifications and may provide additional or different license terms and conditions for use, reproduction, or distribution of Your modifications, or for any such Derivative Works as a whole, provided Your use, reproduction, and distribution of the Work otherwise complies with the conditions stated in this License.

5. Submission of Contributions. Unless You explicitly state otherwise, any Contribution intentionally submitted for inclusion in the Work by You to the Licensor shall be under the terms and conditions of this License, without any additional terms or conditions. Notwithstanding the above, nothing herein shall supersede or modify the terms of any separate license agreement you may have executed with Licensor regarding such Contributions.
6. Trademarks. This License does not grant permission to use the trade names, trademarks, service marks, or product names of the Licensor, except as required for reasonable and customary use in describing the origin of the Work and reproducing the content of the NOTICE file.
7. Disclaimer of Warranty. Unless required by applicable law or agreed to in writing, Licensor provides the Work (and each Contributor provides its Contributions) on an “AS IS” BASIS, WITHOUT WARRANTIES OR CONDITIONS OF ANY KIND, either express or implied, including, without limitation, any warranties or conditions of TITLE, NON-INFRINGEMENT, MERCHANTABILITY, or FITNESS FOR A PARTICULAR PURPOSE. You are solely responsible for determining the appropriateness of using or redistributing the Work and assume any risks associated with Your exercise of permissions under this License.
8. Limitation of Liability. In no event and under no legal theory, whether in tort (including negligence), contract, or otherwise, unless required by applicable law (such as deliberate and grossly negligent acts) or agreed to in writing, shall any Contributor be liable to You for damages, including any direct, indirect, special, incidental, or consequential damages of any character arising as a result of this License or out of the use or inability to use the Work (including but not limited to damages for loss of goodwill, work stoppage, computer failure or malfunction, or any and all other commercial damages or losses), even if such Contributor has been advised of the possibility of such damages.
9. Accepting Warranty or Additional Liability. While redistributing the Work or Derivative Works thereof, You may choose to offer, and charge a fee for, acceptance of support, warranty, indemnity, or other liability obligations and/or rights consistent with this License. However, in accepting such obligations, You may act only on Your own behalf and on Your sole responsibility, not on behalf of any other Contributor, and only if You agree to indemnify, defend, and hold each Contributor harmless for any liability incurred by, or claims asserted against, such Contributor by reason of your accepting any such warranty or additional liability.

END OF TERMS AND CONDITIONS

©2022 Bose Corporation

Licensed under the Apache License, Version 2.0 (the “License”); you may not use this file except in compliance with the License.

You may obtain a copy of the License at: <http://www.apache.org/licenses/LICENSE-2.0>

Unless required by applicable law or agreed to in writing, software distributed under the License is distributed on an “AS IS” BASIS, WITHOUT WARRANTIES OR CONDITIONS OF ANY KIND, either express or implied.

See the License for the specific language governing permissions and limitations under the License.

สิ่งที่อยู่ในกล่อง

สิ่งที่อยู่ในกล่อง.....	13
-------------------------	----

แอปพลิเคชัน BOSE MUSIC

การดาวน์โหลดแอปพลิเคชัน Bose Music	14
เพิ่มหูฟังในบัญชีที่มีอยู่.....	14

ส่วนควบคุมหูฟัง

เปิดเครื่อง	16
การตั้งเวลาสแตนด์บาย.....	16
ปิดเครื่อง	17
ฟังก์ชันของหูฟัง	18
การเล่นสื่อและระดับเสียง	18
การโทร	19
ปุ่มดำเนินการ	20

การตัดเสียงรบกวน

โหมดการตัดเสียงรบกวน	21
เปลี่ยนโหมดการตัดเสียงรบกวน.....	21

การควบคุมด้วยเสียง

เข้าถึงการควบคุมด้วยเสียง	22
---------------------------------	----

การเชื่อมต่อ BLUETOOTH

เชื่อมต่อโดยใช้เมนู <i>Bluetooth</i> บนอุปกรณ์เคลื่อนที่ของคุณ.....	23
ตัดการเชื่อมต่ออุปกรณ์เคลื่อนที่.....	25
เชื่อมต่ออุปกรณ์เคลื่อนที่อีกครั้ง	25
เชื่อมต่ออุปกรณ์เคลื่อนที่เครื่องอื่น	25
ระบุอุปกรณ์เคลื่อนที่ที่เชื่อมต่ออยู่.....	25
สลับระหว่างอุปกรณ์เคลื่อนที่สองเครื่องที่เชื่อมต่ออยู่.....	25
เชื่อมต่ออุปกรณ์ที่เชื่อมต่อไว้ก่อนหน้านี้อีกครั้ง	26
การล้างรายการอุปกรณ์ของหูฟัง	26

การเชื่อมต่อแบบมีสาย

เชื่อมต่อสายสัญญาณเสียง	27
-------------------------------	----

แบตเตอรี่

ชาร์จแบตเตอรี่ของหูฟัง	28
เวลาในการชาร์จ	28
ฟังเสียงแจ้งระดับแบตเตอรี่	28

สถานะหูฟัง

สถานะ Bluetooth	29
สถานะแบตเตอรี่	29
สถานะการชาร์จ	30
สถานะการอัปเดตและข้อผิดพลาด	30

เชื่อมต่อผลิตภัณฑ์ BOSE

เชื่อมต่อ Bose Smart Speaker หรือ Soundbar	31
ข้อดี	31
ผลิตภัณฑ์ที่ใช้งานร่วมกันได้	31
เชื่อมต่อโดยใช้แอปพลิเคชัน Bose Music	31
เชื่อมต่อ Bose Smart Speaker หรือ Soundbar อีกครั้ง	32

การดูแลรักษา

จัดเก็บหูฟัง	33
ทำความสะอาดหูฟัง	34
ชิ้นส่วนสำหรับเปลี่ยนและอุปกรณ์เสริม	34
การรับประกันแบบจำกัด	34
ตำแหน่งหมายเลขซีเรียล	35

การแก้ปัญหา

ลองใช้วิธีแก้ปัญหาต่อไปนี้ก่อน.....	36
วิธีแก้ปัญหาอื่นๆ	36
เรียกคืนหูฟังเป็นการตั้งค่าจากโรงงาน	39

สิ่งที่อยู่ในกล่อง

ตรวจสอบว่าคุณได้รับอุปกรณ์ต่อไปนี้ครบถ้วน:



หูฟัง Bose QuietComfort 45

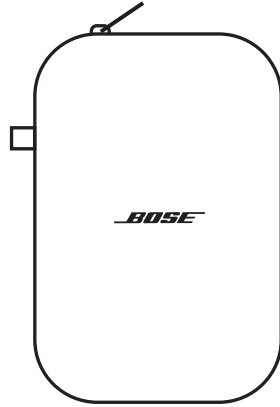

กล่องบรรจุเพื่อพกพาอ่อนนุ่ม



สาย USB Type-C®

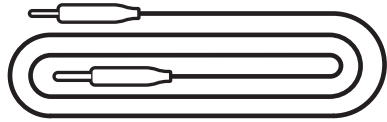

สายสัญญาณเสียงขนาด 3.5 มม. ถึง 2.5 มม.

หมายเหตุ: หากส่วนหนึ่งส่วนใดของอุปกรณ์ได้รับความเสียหาย อย่าใช้อุปกรณ์นี้ ให้ติดต่อตัวแทนจำหน่ายของ Bose หรือติดต่อฝ่ายบริการลูกค้าของ Bose

ไปที่: support.Bose.com/QCSE

แอปพลิเคชัน Bose Music ช่วยให้คุณสามารถตั้งค่าและควบคุมหูฟังจากอุปกรณ์เคลื่อนที่ เช่น สมาร์ทโฟน หรือแท็บเล็ต

ด้วยการใช้แอปพลิเคชันนี้ คุณสามารถจัดการการเชื่อมต่อ *Bluetooth* จัดการการตั้งค่าหูฟัง เลือกภาษา เสียงแจ้งเตือน และเข้าถึงคุณสมบัติใหม่ๆ ผ่านการอัปเดต

หมายเหตุ: หากคุณสร้างบัญชี Bose Music สำหรับผลิตภัณฑ์ Bose ขึ้นเรียบร้อยแล้ว เพิ่มหูฟังไปที่บัญชีที่มีอยู่ของคุณ (ดูหน้า 14 ด้านล่าง)

การดาวน์โหลดแอปพลิเคชัน BOSE MUSIC

1. บนอุปกรณ์เคลื่อนที่ ดาวน์โหลดแอปพลิเคชัน Bose Music

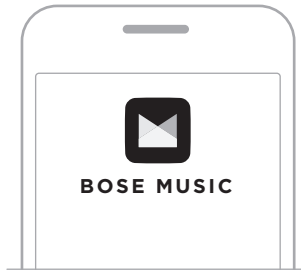

2. ทำตามคำแนะนำของแอปพลิเคชัน

เพิ่มหูฟังในบัญชีที่มีอยู่

หากต้องการเพิ่มหูฟัง Bose QuietComfort 45 เปิดแอปพลิเคชัน Bose Music และเพิ่มหูฟังของคุณ

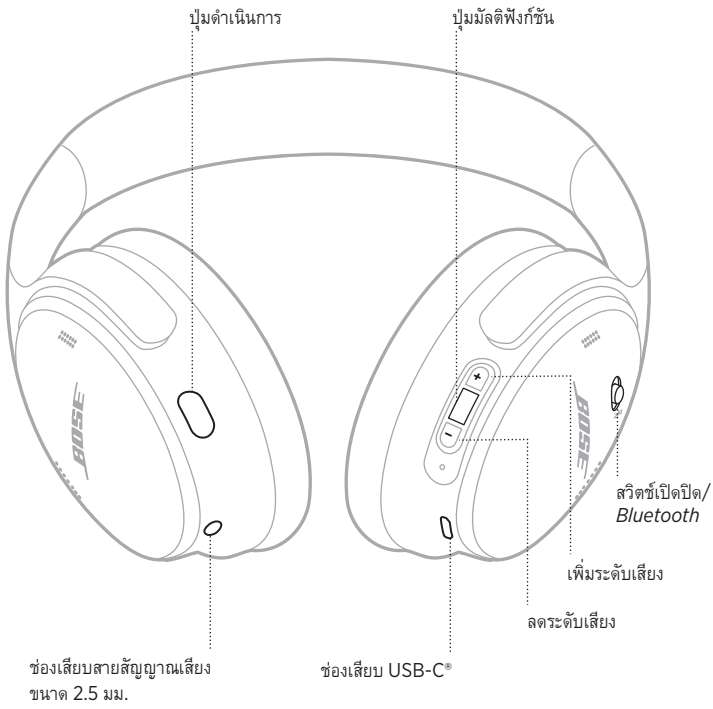

เปิดเครื่อง

บนส่วนครอบหูด้านขวา เลื่อนสวิตช์เปิดปิด/*Bluetooth* ไปทางขวา

ข้อความเสียงแจ้งจะประกาศระดับประจุแบตเตอรี่และไฟแสดงสถานะติดสว่างตามระดับประจุปัจจุบัน (ดูหน้า 29)



การตั้งเวลาสแตนด์บาย

การตั้งเวลาสแตนด์บายจะช่วยสงวนรักษาแบตเตอรี่ขณะที่ไม่ได้ใช้งานหูฟัง

หากต้องการตั้งค่าและปรับแต่งการตั้งเวลาสแตนด์บาย ใช้แอปพลิเคชัน Bose Music

ปิดเครื่อง

เลื่อนสวิตช์เปิดปิด/Bluetooth ไปทางซ้าย



หมายเหตุ: เมื่อปิดหูฟัง การตัดเสียงรบกวนจะถูกปิดใช้งาน

ฟังก์ชันของหูฟัง

ส่วนควบคุมของหูฟังอยู่ที่ด้านหลังของส่วนครอบหูด้านขวา

การเล่นสื่อและระดับเสียง

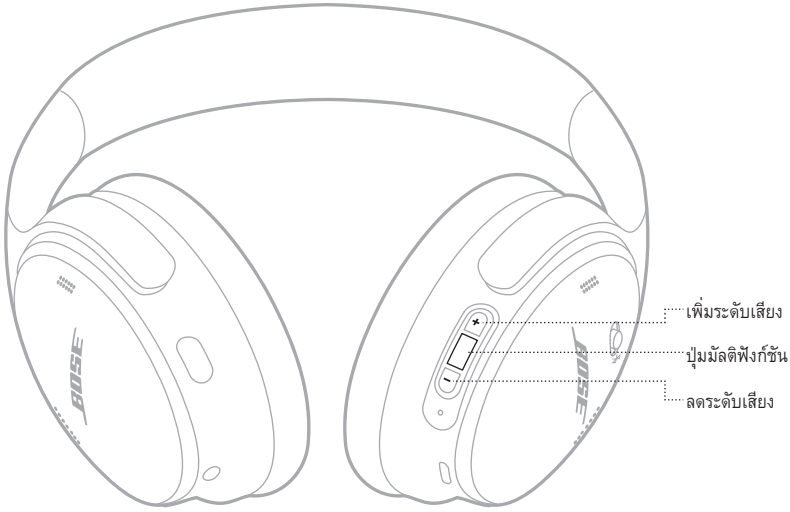

ฟังก์ชัน

สิ่งที่ต้องทำ

เล่น/หยุดชั่วคราว	กดปุ่มมัลติฟังก์ชัน
ข้ามไปข้างหน้า	กดปุ่มมัลติฟังก์ชันสองครั้ง
ข้ามย้อนกลับ	กดปุ่มมัลติฟังก์ชันสามครั้ง
เพิ่มระดับเสียง	กด +
ลดระดับเสียง	กด -

หมายเหตุ:

- หากต้องการเพิ่มระดับเสียงอย่างรวดเร็ว กด + ค้างไว้
- หากต้องการลดระดับเสียงอย่างรวดเร็ว กด - ค้างไว้

การโทร

ปุ่มมัลติฟังก์ชันอยู่ที่ด้านหลังของส่วนครอบหูด้านขวา ไมโครโฟนอยู่ใกล้ด้านหน้าของส่วนครอบหูทางด้านขวา

ปุ่มดำเนินการอยู่ที่ด้านหลังของส่วนครอบหูด้านซ้าย

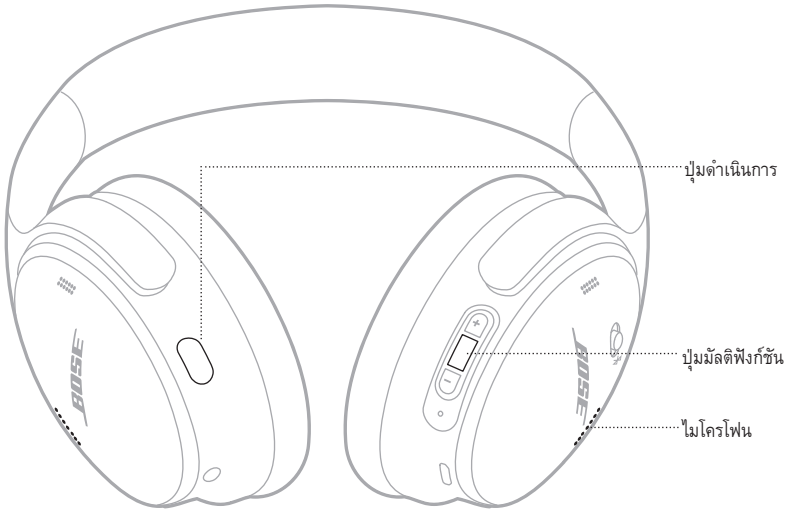

ฟังก์ชัน

สิ่งที่ต้องทำ

ฟังก์ชัน	สิ่งที่ต้องทำ
รับสาย/วางสาย	กดปุ่มมัลติฟังก์ชัน
ปฏิเสธสายเรียกเข้า	กดปุ่มมัลติฟังก์ชันค้างไว้ 1 วินาที
รับสายเรียกเข้าสายที่สอง และพักสายที่ใช้อยู่	ขณะใช้สายและมีสายที่สองเรียกเข้า กดปุ่มมัลติฟังก์ชัน
ปฏิเสธสายเรียกเข้าสายที่สอง และคงอยู่ในสายที่ใช้อยู่	ขณะใช้สายและมีสายที่สองเรียกเข้า กดปุ่มมัลติฟังก์ชันค้างไว้ 1 วินาที
สลับระหว่างสองสาย	เมื่อมีสายที่ใช้งานอยู่สองสาย กดปุ่มมัลติฟังก์ชันสองครั้ง
สร้างการประชุมทางโทรศัพท์	เมื่อมีสายที่ใช้งานอยู่สองสาย กดปุ่มมัลติฟังก์ชันค้างไว้ 3 วินาที
ปิด/เปิดเสียงโทร	ขณะใช้สาย กดปุ่มดำเนินการสองครั้ง

ปุ่มดำเนินการ

ปุ่มดำเนินการช่วยให้คุณสลับระหว่างโหมดตัดเสียงรบกวนต่างๆ อย่างรวดเร็วและง่ายดาย

ปุ่มดำเนินการอยู่ที่ด้านหลังของส่วนครอบหูด้านซ้าย

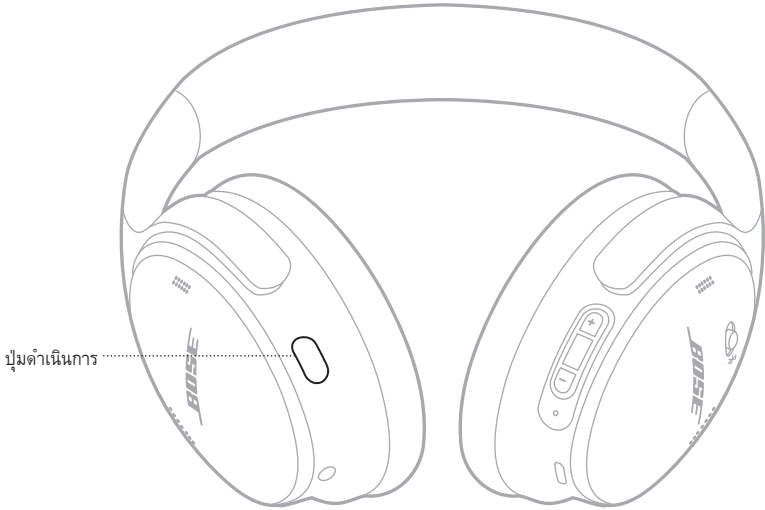

หากต้องการสลับระหว่างโหมดเงียบและโหมดรับรู้ กดปุ่มดำเนินการ

สำหรับข้อมูลเพิ่มเติมเกี่ยวกับโหมดการตัดเสียงรบกวน ดูหน้า 21

การตัดเสียงรบกวนช่วยลดเสียงรบกวนที่ไม่ต้องการ พร้อมทั้งให้ประสิทธิภาพเสียงสมจริงและชัดเจนยิ่งขึ้น คุณสามารถเลือกระหว่างโหมดการตัดเสียงรบกวนสองโหมด: เงียบและรับรู้

โหมดเงียบช่วยให้คุณสามารถปิดกั้นการรบกวนโดยใช้การตัดเสียงรบกวนระดับสูงสุด

โหมดรับรู้ให้เสียงกระจ่างใสอย่างสมบูรณ์และช่วยให้คุณได้ยินเสียงรอบข้างขณะเพลิดเพลินกับเสียงจากอุปกรณ์ของคุณ

เลือกโหมดการตัดเสียงรบกวนของคุณโดยอิงกับแนวเพลงที่ฟังและสภาพแวดล้อม

โหมดการตัดเสียงรบกวน

โหมด	รายละเอียด
เงียบ	เทคโนโลยีการตัดเสียงรบกวนระดับโลกมาพร้อมเสียงที่เพิ่มประสิทธิภาพจาก Bose
รับรู้	ได้ยินเสียงรอบข้างขณะเพลิดเพลินกับเสียงจากอุปกรณ์ของคุณ

หมายเหตุ: เมื่อเปิด หูฟังจะปรับเป็นค่าเริ่มต้นตามโหมดล่าสุดที่คุณใช้

เปลี่ยนโหมดการตัดเสียงรบกวน

หากต้องการเปลี่ยนโหมดการตัดเสียงรบกวน กดปุ่มดำเนินการ

จะมีเสียงแจ้งโหมดการตัดเสียงรบกวนที่เลือก

เคล็ดลับ: คุณยังสามารถเปลี่ยนโหมดการตัดเสียงรบกวนโดยใช้แอปพลิเคชัน Bose Music

เข้าถึงการควบคุมด้วยเสียง

คุณสามารถใช้หูฟังเพื่อเข้าถึงการควบคุมด้วยเสียงบนอุปกรณ์เคลื่อนที่ของคุณ หากต้องการเข้าถึงการควบคุมด้วยเสียง กดปุ่มมัลติฟังก์ชันค้างไว้ 1 วินาที

ปุ่มมัลติฟังก์ชันอยู่ที่ด้านหลังของส่วนครอบหูด้านขวา

หมายเหตุ: คุณไม่สามารถเข้าถึงการควบคุมด้วยเสียงในขณะที่ใช้สาย

เชื่อมต่อโดยใช้เมนู **BLUETOOTH** บนอุปกรณ์เคลื่อนที่ของคุณ

คุณสามารถจัดเก็บอุปกรณ์ได้สูงสุดถึงแปดเครื่องในรายการการจับคู่ของหูฟัง และหูฟังของคุณสามารถเชื่อมต่อกับอุปกรณ์สองเครื่องพร้อมกันที่ทำงานอยู่ คุณสามารถเล่นเพลงจากอุปกรณ์ได้หนึ่งเครื่องในแต่ละครั้ง

หมายเหตุ: เพื่อให้ได้รับประสบการณ์ที่ดีที่สุด ใช้แอปพลิเคชัน Bose Music ตั้งค่าและเชื่อมต่ออุปกรณ์เคลื่อนที่ของคุณ (ดูหน้า 14)

1. เลื่อนสวิตช์เปิดปิด/*Bluetooth* ไปทางขวา ✳ และค้างไว้เป็นเวลา 3 วินาที

คุณจะได้ยินเสียง “พร้อมเชื่อมต่อ” และไฟแสดงสถานะสีน้ำเงินกะพริบ



2. เปิดใช้งานคุณสมบัติ **Bluetooth** บนอุปกรณ์ของคุณ

หมายเหตุ: คุณสมบัตื **Bluetooth** จะพบได้ในเมนูการตั้งค่า

3. เลือกหูฟังของคุณจากรายการอุปกรณ์

เคล็ดลับ: ค้นหาชื่อที่คุณป้อนสำหรับหูฟังของคุณในแอปพลิเคชัน Bose Music หากคุณไม่ได้ป้อนชื่อหูฟังของคุณ ชื่อที่เป็นค่าเริ่มต้นจะปรากฏขึ้น



เมื่อเชื่อมต่อแล้ว คุณจะได้ยินเสียง “เชื่อมต่อกับ<ชื่ออุปกรณ์> แล้ว” และไฟแสดงสถานะจะสว่างหนึ่งเป็นสีน้ำเงินนาน 10 วินาที

ตัดการเชื่อมต่ออุปกรณ์เคลื่อนที่

ใช้แอปพลิเคชัน Bose Music เพื่อตัดการเชื่อมต่ออุปกรณ์เคลื่อนที่ของคุณ

เคล็ดลับ: คุณยังสามารถใช้การตั้งค่า *Bluetooth* เพื่อตัดการเชื่อมต่ออุปกรณ์ของคุณ การปิดใช้งานคุณสมบัติ *Bluetooth* จะตัดการเชื่อมต่ออุปกรณ์อื่นๆ ทั้งหมด

เชื่อมต่ออุปกรณ์เคลื่อนที่อีกครั้ง

เมื่อเปิด หูฟังจะพยายามเชื่อมต่อกับอุปกรณ์สองเครื่องที่ทำการเชื่อมต่อล่าสุดโดยอัตโนมัติ

หมายเหตุ:

- อุปกรณ์ต้องอยู่ภายในระยะทำงาน (30 ฟุตหรือ 9 ม.) และเปิดอยู่
- ตรวจสอบให้แน่ใจว่าเปิดใช้งานคุณสมบัติ *Bluetooth* บนอุปกรณ์เคลื่อนที่ของคุณแล้ว

เชื่อมต่ออุปกรณ์เคลื่อนที่เครื่องอื่น

หากต้องการเชื่อมต่อกับอุปกรณ์เพิ่มเติม ดาวนโหลดแอปพลิเคชัน Bose Music (ดูหน้า 14) หรือใช้เมนู *Bluetooth* บนอุปกรณ์เคลื่อนที่ของคุณ (ดูหน้า 23)

หมายเหตุ: คุณสามารถเล่นเพลงจากอุปกรณ์หนึ่งเครื่องในแต่ละครั้ง

ระบุอุปกรณ์เคลื่อนที่ที่เชื่อมต่ออยู่

เลื่อนสวิตช์เปิดปิด/*Bluetooth* ไปทางขวา ✧ และปล่อยเพื่อรับฟังว่าอุปกรณ์ใดเชื่อมต่ออยู่

สลับระหว่างอุปกรณ์เคลื่อนที่สองเครื่องที่เชื่อมต่ออยู่

1. หยุดเพลงบนอุปกรณ์เคลื่อนที่เครื่องแรกของคุณชั่วคราว
2. เล่นเพลงบนอุปกรณ์เคลื่อนที่เครื่องที่สอง

หมายเหตุ: หูฟังของคุณสามารถรับสายโทรศัพท์จากอุปกรณ์ทั้งสองเครื่อง แม้อุปกรณ์เครื่องใดเครื่องหนึ่งกำลังเล่นเสียงอยู่ก็ตาม

เชื่อมต่ออุปกรณ์ที่เชื่อมต่อไว้ก่อนหน้านี้อีกครั้ง

1. เลื่อนสวิตช์เปิดปิด/*Bluetooth* ไปทางขวา ✖ และปล่อยเพื่อรับฟังว่าอุปกรณ์ใดเชื่อมต่ออยู่
2. ภายใน 2 วินาที เลื่อนสวิตช์เปิดปิด/*Bluetooth* ไปทางขวา ✖ และปล่อยอีกครั้งเพื่อเชื่อมต่ออุปกรณ์ถัดไปในรายการอุปกรณ์ของหูฟัง
3. ทำซ้ำจนกระทั่งคุณได้ยินชื่ออุปกรณ์ที่ต้องการ
คุณจะได้ยินเสียงแจ้งเมื่ออุปกรณ์เชื่อมต่อแล้ว
4. เล่นเพลงบนอุปกรณ์เคลื่อนที่ที่เชื่อมต่อ

หมายเหตุ: หากอุปกรณ์สองเครื่องเชื่อมต่อกับหูฟังอยู่แล้ว อุปกรณ์ที่เชื่อมต่อล่าสุดจะแทนที่อุปกรณ์เครื่องที่สองที่เชื่อมต่อก่อนหน้านี้

การล้างรายการอุปกรณ์ของหูฟัง

1. เลื่อนสวิตช์เปิดปิด/*Bluetooth* ไปทางขวา ✖ และค้างไว้เป็นเวลา 15 วินาที จนกว่าคุณจะได้ยินเสียง “ล้างรายการอุปกรณ์ *Bluetooth* แล้ว พร้อมเชื่อมต่อ”
2. ลบหูฟังของคุณจากรายการ *Bluetooth* บนอุปกรณ์เคลื่อนที่ของคุณ
อุปกรณ์ทั้งหมดจะถูกล้าง และหูฟังพร้อมสำหรับการเชื่อมต่อ

เชื่อมต่อสายสัญญาณเสียง

ใช้สายเคเบิลขนาด 2.5-3.5 มม. เพื่อเชื่อมต่ออุปกรณ์แบบมีสายหรือเพื่อใช้หูฟังอย่างต่อเนื่อง หากแบตเตอรี่ของหูฟังหมด

1. เชื่อมต่อสายเข้ากับช่องเสียบขนาด 2.5 มม. ที่ด้านซ้ายของส่วนครอบหู



2. เชื่อมต่อปลายสายอีกด้านเข้ากับช่องเสียบขนาด 3.5 มม. บนอุปกรณ์ของคุณ

หมายเหตุ: คุณสามารถใช้หูฟังที่เปิดหรือปิดอยู่เมื่อเชื่อมต่อสายสัญญาณเสียงแล้ว

ชาร์จแบตเตอรี่ของหูฟัง

1. เชื่อมต่อปลายสายด้านเล็กของสายเคเบิล USB เข้ากับช่องเสียบ USB-C ที่ด้านขวาของส่วนครอบหู
2. เชื่อมต่อปลายสายอีกด้านหนึ่งเข้ากับอุปกรณ์ชาร์จ USB ที่ผนัง



หมายเหตุ:

- เมื่อหูฟังเริ่มชาร์จ ไฟแสดงสถานะจะเป็นสีเขียวกะพริบนาน 10 วินาที เมื่อชาร์จเต็มแล้ว ไฟแสดงสถานะจะสว่างนิ่งเป็นสีขาว
- หูฟังไม่เล่นเสียงขณะชาร์จ

เวลาในการชาร์จ

ให้เวลาชาร์จจนแบตเตอรี่เต็มไม่เกิน 2.5 ชั่วโมง

ฟังเสียงแจ้งระดับแบตเตอรี่

ทุกครั้งที่คุณเปิดหูฟัง จะมีเสียงแจ้งระดับประจุแบตเตอรี่ เมื่อแบตเตอรี่หูฟังอ่อน คุณจะได้ยินเสียงเตือน “แบตเตอรี่อ่อน โปรดชาร์จทันที”

หมายเหตุ: หากต้องการตรวจสอบแบตเตอรี่ด้วยสายตา ดูไฟแสดงสถานะบนส่วนครอบหูด้านขวา สำหรับข้อมูลเพิ่มเติม ดู “สถานะแบตเตอรี่” ที่หน้า 29

ไฟแสดงสถานะอยู่ที่ส่วนครอบหูด้านขวา



สถานะ **BLUETOOTH**

แสดงสถานะการเชื่อมต่อ Bluetooth

การทำงานของไฟ	สถานะระบบ
สีน้ำเงินกะพริบ	พร้อมเชื่อมต่อ
สีน้ำเงินสว่างหนึ่ง (10 วินาที)	เชื่อมต่อแล้ว

สถานะแบตเตอรี่

แสดงระดับแบตเตอรี่

การทำงานของไฟ	สถานะระบบ
สีขาวสว่างหนึ่ง	มีประจุปานกลางถึงเต็ม
สีอำพันสว่างหนึ่ง	ประจุใกล้หมด

เคล็ดลับ: คุณยังสามารถตรวจสอบระดับแบตเตอรี่โดยใช้แอปพลิเคชัน Bose Music

สถานะการชาร์จ

แสดงสถานะการชาร์จ

การทำงานของไฟ	สถานะระบบ
เป็นสีขาวกะพริบ 2 ครั้ง	เริ่มการชาร์จ
สีอำพันสว่างหนึ่ง	กำลังชาร์จ
สีขาวสว่างหนึ่ง	มีประจุเต็ม

สถานะการอัปเดตและข้อผิดพลาด

แสดงสถานะการอัปเดตหรือข้อผิดพลาด

การทำงานของไฟ	สถานะระบบ
สีขาวกะพริบเร็ว (10 วินาที)	กำลังอัปเดตซอฟต์แวร์ (ผ่าน USB)
สีขาวกะพริบช้า (30-60 วินาที)	กำลังอัปเดตซอฟต์แวร์ (แบบไร้สาย)
สีอำพันและสีขาวกะพริบ	ข้อผิดพลาด - ติดต่อฝ่ายบริการลูกค้าของ Bose

เชื่อมต่อ BOSE SMART SPEAKER หรือ SOUNDBAR

ด้วยการใช้เทคโนโลยี SimpleSync™ คุณสามารถเชื่อมต่อหูฟังกับ Bose Smart Soundbar หรือ Bose Smart Speaker เพื่อประสบการณ์ฟังเพลงเฉพาะตัวของคุณ

ข้อดี

- ใช้การควบคุมระดับเสียงอย่างเป็นอิสระบนอุปกรณ์แต่ละเครื่องเพื่อลดระดับเสียงหรือปิดเสียง Bose Smart Soundbar ได้โดยหูฟังยังคงให้เสียงดังในระดับที่คุณต้องการ
- ฟังเสียงเพลงชัดใสจากห้องที่อยู่ติดกันโดยการเชื่อมต่อหูฟังกับ Bose Smart Speaker ของคุณ

หมายเหตุ: เทคโนโลยี SimpleSync™ มีระยะการทำงานของ Bluetooth® สูงสุดที่ 9 เมตร ผั่งและสิ่งก่อสร้างต่างๆ มีผลต่อการรับสัญญาณนี้

ผลิตภัณฑ์ที่ใช้งานร่วมกันได้

คุณสามารถเชื่อมต่อหูฟังกับ Bose Smart Speaker หรือ Bose Smart Soundbar

ผลิตภัณฑ์ที่ใช้งานร่วมกันได้ที่นิยมจับคู่ได้แก่:

- Bose Smart Soundbar 700/Bose Soundbar 700
- Bose Soundbar 500
- Bose Smart Speaker 500/Bose Home Speaker 500
- Bose Home Speaker 300
- Bose Portable Smart Speaker/Bose Portable Home Speaker

โดยมีผลิตภัณฑ์ใหม่เพิ่มเป็นระยะๆ สำหรับรายชื่อทั้งหมดและข้อมูลเพิ่มเติมไปที่: worldwide.bose.com/Support/Groups

เชื่อมต่อโดยใช้แอปพลิเคชัน Bose Music

1. บนหูฟัง เลื่อนสวิตช์เปิดปิด/Bluetooth ไปทางขวา ✖ และค้างไว้ 3 วินาที
คุณจะได้ยินเสียง “พร้อมเชื่อมต่อกับอุปกรณ์อื่น” และไฟแสดงสถานะกะพริบเป็นสีน้ำเงิน
2. ใช้แอปพลิเคชัน Bose Music เพื่อเชื่อมต่อหูฟังกับผลิตภัณฑ์ Bose ที่ใช้งานร่วมกันได้ สำหรับข้อมูลเพิ่มเติม โปรดเยี่ยมชม: worldwide.bose.com/Support/Groups

หมายเหตุ:

- ตรวจสอบให้แน่ใจว่าหูฟังอยู่ในระยะ 9 ม. จาก Soundbar หรือลำโพง
- คุณสามารถเชื่อมต่อหูฟังกับผลิตภัณฑ์ได้ครั้งละหนึ่งเครื่องเท่านั้น

เชื่อมต่อ **BOSE SMART SPEAKER** หรือ **SOUNDBAR** อีกครั้ง

เปิดหูฟัง (ดู "เปิดเครื่อง" ที่หน้า 16)

หูฟังพยายามเชื่อมต่อกับอุปกรณ์ *Bluetooth* สองเครื่องที่เชื่อมต่อล่าสุด รวมถึง Soundbar หรือลำโพง

หมายเหตุ:

- Soundbar หรือลำโพงของคุณต้องอยู่ภายในระยะทำงาน (30 ฟุตหรือ 9 ม.) และเปิดอยู่
- หากหูฟังไม่เชื่อมต่อ ดู "หูฟังไม่เชื่อมต่ออีกครั้งกับ Bose Smart Soundbar หรือลำโพงที่เชื่อมต่อก่อนหน้านี้" ที่หน้า 38

จัดเก็บหูฟัง

ส่วนประกอบสามารถหมุนได้เพื่อการจัดเก็บที่ง่ายและสะดวก วางหูฟังลงในกล่องบรรจุเพื่อพกพา

1. หมุนส่วนครอบหูทั้งสองด้านเข้าด้านในจนกระทั่งเรียบสนิท



2. พับส่วนครอบหูด้านซ้ายขึ้นไปทางแถบสวมศีรษะ

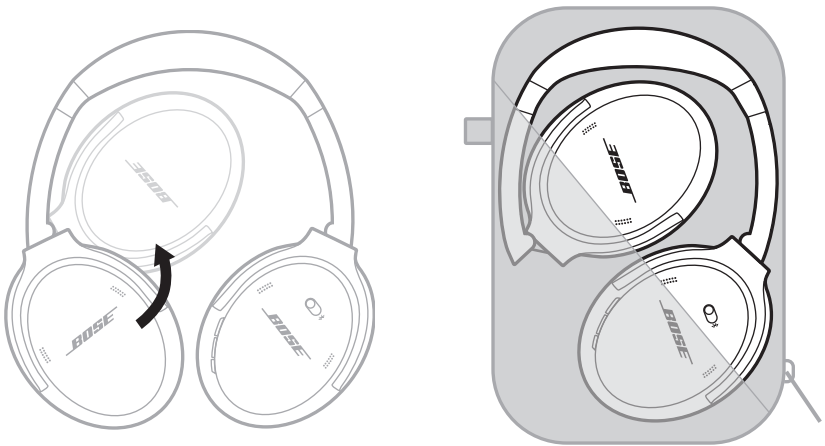

หมายเหตุ:

- ตรวจสอบให้แน่ใจว่าปิดหูฟังเมื่อไม่ใช้งาน
- ก่อนจัดเก็บหูฟังไว้หลาย ๆ เดือน โปรดตรวจสอบให้แน่ใจว่าชาร์จแบตเตอรี่ไว้เต็มแล้ว

ทำความสะอาดหูฟัง

ใช้ผ้าแห้งและนุ่มเช็ดที่พื้นผิวด้านนอก

ระวังอย่าให้ความชื้นเข้าสู่ด้านในของส่วนครอบหู

ชิ้นส่วนสำหรับเปลี่ยนและอุปกรณ์เสริม

ชิ้นส่วนสำหรับเปลี่ยนและอุปกรณ์เสริมสามารถสั่งซื้อได้จากฝ่ายบริการลูกค้าของ Bose เยี่ยมชม: support.Bose.com/QCSE

การรับประกันแบบจำกัด

หูฟังของคุณได้รับความคุ้มครองจากการรับประกันแบบจำกัด เยี่ยมชมเว็บไซต์ของเราที่ worldwide.Bose.com/Warranty สำหรับรายละเอียดของการรับประกันแบบจำกัด

หากต้องการลงทะเบียนผลิตภัณฑ์ของคุณ โปรดเยี่ยมชม worldwide.Bose.com/ProductRegistration สำหรับคำแนะนำ แม้จะไม่ดำเนินการดังกล่าวก็จะมีผลต่อการรับประกันแบบจำกัดของคุณ

ตำแหน่งหมายเลขซีเรียล

หมายเลขซีเรียลอยู่ในส่วนครอบหูด้านขวาใต้วัสดุบุ วัสดุบุเป็นวัสดุปิดตันในเพื่อคลุมและป้องกันส่วนประกอบภายในส่วนครอบหูด

หากต้องการดูหมายเลขซีเรียล จับวัสดุบุที่ขอบด้านบนและค่อยๆ ดึงออก

ข้อควรระวัง: ระวังอย่ากดหรือทำให้ส่วนประกอบภายในส่วนครอบหูดึงหลุดออก เนื่องจากอาจทำให้หูฟังเสียหาย

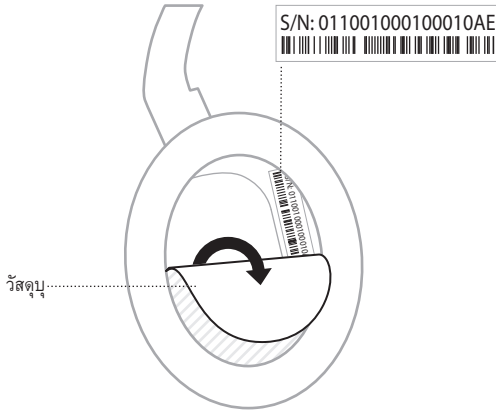

ลองใช้วิธีแก้ปัญหาต่อไปนี้ก่อน

หากคุณประสบปัญหาเกี่ยวกับหูฟังของคุณ:

- ตรวจสอบสถานะของไฟแสดงสถานะ (ดูหน้า 29)
- ดำเนินการชาร์จแบตเตอรี่ (ดูหน้า 28)
- เพิ่มระดับเสียงบนหูฟัง อุปกรณ์เคลื่อนที่ และแอปพลิเคชันเพลงของคุณ
- ดาวนโหลดแอปพลิเคชัน Bose Music และเรียกใช้งานอัปเดตซอฟต์แวร์ที่พร้อมใช้งาน (ดูหน้า 14)
- ลองเชื่อมต่อกับอุปกรณ์เคลื่อนที่อื่น (ดูหน้า 25)

หากคุณไม่สามารถแก้ปัญหาของคุณได้ โปรดดูตารางด้านล่างเพื่อระบุอาการและวิธีแก้ปัญหาสำหรับปัญหาทั่วไป หากคุณยังไม่สามารถแก้ปัญหาได้ ติดต่อฝ่ายบริการลูกค้าของ Bose

ไปที่: worldwide.Bose.com/contact

วิธีแก้ปัญหาอื่น ๆ

อาการ	วิธีการแก้ไข
หูฟังไม่เปิด	ดำเนินการชาร์จแบตเตอรี่
หูฟังไม่เชื่อมต่อกับอุปกรณ์เคลื่อนที่	<p>ตัดการเชื่อมต่อสายสัญญาณเสียงสำรอง</p> <p>ตัดการเชื่อมต่อสายชาร์จ USB</p> <p>บนอุปกรณ์เคลื่อนที่ของคุณ:</p> <p>ปิดใช้งานแล้วเปิดใช้คุณสมบัติ <i>Bluetooth</i> อีกครั้ง</p> <p>ลบหูฟัง Bose QuietComfort 45 ของคุณออกจากรายการ <i>Bluetooth</i> บนอุปกรณ์ของคุณ รวมถึงรายการที่แสดงซ้ำที่มีคำว่า LE (Low Energy) เชื่อมต่ออีกครั้ง</p> <p>เลื่อนอุปกรณ์เคลื่อนที่ของคุณเข้าใกล้หูฟังมากขึ้น และให้ไกลจากแหล่งสัญญาณรบกวนหรือสิ่งกีดขวาง</p> <p>ไปที่ support.Bose.com/QCSE เพื่อดูวิดีโอวิธีการใช้งาน</p> <p>ล้างรายการอุปกรณ์ที่เชื่อมต่อ (ดูหน้า 26) และเชื่อมต่ออีกครั้ง</p>
ชาร์จแบตเตอรี่ไม่ได้	<p>เสียบปลั๊กสายชาร์จ USB ให้แน่น</p> <p>ลองแหล่งชาร์จแหล่งอื่น</p> <p>หากหูฟังของคุณอยู่ในบริเวณที่มีอุณหภูมิสูงหรือต่ำ ปลดปล่อยให้หูฟังกลับสู่อุณหภูมิห้อง และลองชาร์จอีกครั้ง</p>

อาการ	วิธีการแก้ไข
ไม่มีเสียง	<p>เปิดหูฟังและชาร์จแบตเตอรี่</p> <p>ตรวจสอบสถานะของไฟแสดงสถานะ (ดูหน้า 29)</p> <p>เลื่อนสวิตช์เปิดปิด/<i>Bluetooth</i> ไปทางขวาและปล่อยเพื่อรับฟังอุปกรณ์ที่เชื่อมต่อ ตรวจสอบให้แน่ใจว่าคุณใช้อุปกรณ์ที่ถูกต้อง</p> <p>เลื่อนอุปกรณ์เคลื่อนที่ของคุณเข้าใกล้หูฟังมากขึ้น และให้ไกลจากแหล่งสัญญาณรบกวนหรือสิ่งกีดขวาง</p> <p>ใช้แหล่งสัญญาณเพลงแหล่งอื่น</p> <p>หากอุปกรณ์เคลื่อนที่สองเครื่องเชื่อมต่ออยู่ ให้หยุดอุปกรณ์เคลื่อนที่อีกเครื่องไว้ชั่วคราวก่อน</p> <p>หากอุปกรณ์เคลื่อนที่สองเครื่องเชื่อมต่ออยู่ เลื่อนอุปกรณ์ทั้งสองเครื่องอยู่ภายในระยะการทำงานของหูฟัง (30 ฟุตหรือ 9 ม.)</p> <p>ลองเล่นไฟล์เพลงหรือไฟล์วิดีโอที่จัดเก็บอยู่ในอุปกรณ์เคลื่อนที่ของคุณ</p>
คุณภาพเสียงไม่ดี	<p>ใช้แหล่งสัญญาณเพลงแหล่งอื่น</p> <p>เชื่อมต่ออุปกรณ์เคลื่อนที่เครื่องอื่น (ดูหน้า 25)</p> <p>ยกเลิกการเชื่อมต่อกับอุปกรณ์เครื่องที่สอง</p> <p>เลื่อนอุปกรณ์เคลื่อนที่ของคุณเข้าใกล้หูฟังมากขึ้น และให้ไกลจากแหล่งสัญญาณรบกวนหรือสิ่งกีดขวาง</p> <p>ลองเล่นไฟล์เพลงหรือไฟล์วิดีโอที่จัดเก็บอยู่ในอุปกรณ์เคลื่อนที่ของคุณ</p>
ไม่ได้ยินเสียงจากอุปกรณ์ที่เชื่อมต่อด้วยสายสัญญาณเสียงสำรอง	<p>เสียบปลายสายสัญญาณเสียงสำรองให้แน่น</p> <p>เพิ่มระดับเสียงของหูฟัง อุปกรณ์เคลื่อนที่ของคุณ และแหล่งสัญญาณเพลง</p> <p>เชื่อมต่ออุปกรณ์เครื่องอื่น (ดูหน้า 25)</p>
คุณภาพเสียงจากอุปกรณ์ที่เชื่อมต่อด้วยสายสัญญาณเสียงไม่ดี	<p>เสียบปลายสายสัญญาณเสียงสำรองให้แน่น</p> <p>เชื่อมต่ออุปกรณ์เครื่องอื่น (ดูหน้า 25)</p>
ปุ่มดำเนินการไม่ได้เปลี่ยนโหมดการตัดเสียงรบกวน	<p>ตรวจสอบให้แน่ใจว่าเปิดหูฟังแล้ว</p> <p>ใช้แอปฟลิเคชัน Bose Music เพื่อเปลี่ยนโหมดการตัดเสียงรบกวน</p>

อาการ	วิธีการแก้ไข
<p>หูฟังไม่เชื่อมต่อกับ Bose Smart Soundbar หรือลำโพง</p>	<p>เลื่อนปุ่มเปิดปิด/<i>Bluetooth</i> ค้างไว้จนกระทั่งคุณได้ยินเสียง “พร้อมเชื่อมต่อกับอุปกรณ์อื่น” และไฟสัญญาณ <i>Bluetooth</i> จะพริบเป็นสีน้ำเงิน</p> <p>ตรวจสอบให้แน่ใจว่าหูฟังอยู่ในระยะ 9 ม. จาก Soundbar หรือลำโพง</p>
<p>หูฟังไม่เชื่อมต่ออีกครั้งกับ Bose Smart Soundbar หรือลำโพงที่เชื่อมต่อก่อนหน้านี้</p>	<p>เชื่อมต่ออุปกรณ์ที่เชื่อมต่อก่อนหน้านี้อีกครั้ง (ดูหน้า 26)</p>
<p>เสียงห่วยเมื่อเชื่อมต่อกับ Bose Smart Soundbar หรือลำโพง</p>	<p>ดาวน์โหลดแอปพลิเคชัน Bose Music และเรียกใช้งานแอปเดสทอปแวร์ที่พร้อมใช้งาน</p>

การเรียกคืนการตั้งค่าจากโรงงานจะล้างการตั้งค่าทั้งหมดและทำให้หูฟังกลับสู่สถานะตามค่าเริ่มต้นดั้งเดิม หลังจากนั้น คุณสามารถกำหนดค่าหูฟังร่วมกับหูฟังที่ได้รับการตั้งค่าครั้งแรก

แนะนำให้เรียกคืนการตั้งค่าจากโรงงานหากคุณกำลังมีปัญหาเกี่ยวกับหูฟังเท่านั้น หรือคุณได้รับคำแนะนำให้ดำเนินการดังกล่าวจากฝ่ายบริการลูกค้าของ Bose

เรียกคืนหูฟังเป็นการตั้งค่าจากโรงงาน

1. ลบหูฟังออกจากรายการ *Bluetooth* บนอุปกรณ์ของคุณ
2. ลบหูฟังออกจากบัญชี Bose ของคุณโดยใช้แอปพลิเคชัน Bose Music

หมายเหตุ: สำหรับข้อมูลเพิ่มเติมเกี่ยวกับวิธีลบหูฟังออกจากบัญชี Bose ของคุณโดยใช้แอปพลิเคชัน Bose Music ไปที่: support.Bose.com/QCSE

3. เลื่อนสวิตช์เปิดปิด/*Bluetooth* ไปทางขวา ✖ และค้างไว้ ขณะเดียวกัน กดปุ่มดำเนินการค้างไว้ 30 วินาที
4. ไฟแสดงสถานะสีขาวจะกะพริบ หลังจาก 30 วินาที ไฟแสดงสถานะจะเป็นสีเหลืองกะพริบเพื่อระบุว่ามีการเรียกคืนการตั้งค่าจากโรงงาน (2-3 วินาที)
5. เมื่อการเรียกคืนค่าเสร็จสิ้น ไฟแสดงสถานะจะเป็นสีน้ำเงินกะพริบซ้ำๆ ขณะนี้หูฟังอยู่ในสถานะตามค่าเริ่มต้นดั้งเดิม

모든 안전, 보안 및 사용 지침을 읽고 보관하십시오.

CE Bose Corporation은 이 제품이 지침서 2014/53/EU 및 기타 모든 적용 가능한 EU 지침의 필수 요건과 관련 조항을 준수하고 있음을 여기에서 선언합니다. 표준 부합 신고서 전문은 다음을 참조하십시오. www.Bose.com/compliance

UK CA 이 제품은 모든 적용 가능한 전자기 호환성 규정 2016 및 기타 모든 적용 가능한 영국 규정을 준수합니다. 표준 부합 신고서 전문은 다음을 참조하십시오. www.Bose.com/compliance

Bose Corporation은 이 제품이 무선 장비 규정 2017에 따른 필수 요건과 다른 모든 해당 영국 규정을 준수함을 선언합니다. 표준 부합 신고서 전문은 다음을 참조하십시오. www.Bose.com/compliance

중요 안전 지침

본 기기를 물 가까이에서 사용하지 마십시오.

마른 헝겊으로만 닦으십시오.

가격 있는 기사에게만 서비스를 의뢰하십시오. 전원 코드 또는 플러그가 손상되었을 때, 액체가 흘러 들어갔을 때, 물체가 떨어져 기기 안에 들어갔을 때, 기기가 비나 물에 젖었을 때, 정상적으로 작동하지 않을 때, 또는 기기를 떨어뜨렸을 때 등, 어느 경우라도 기기가 손상되었을 때는 서비스를 받으셔야 합니다.

경고/주의

- 오랫동안 큰 볼륨으로 헤드폰을 사용하지 마십시오.
 - 청력 손상을 피하려면 편안한 중간 볼륨으로 헤드폰을 사용하십시오.
 - 헤드폰을 귀에 착용하기 전에 장치에서 볼륨을 줄인 후 편안한 청취 수준으로 서서히 볼륨을 올리십시오.
- 운전 중 통화나 기타 다른 목적으로 헤드폰을 사용하지 마십시오.
- 예를 들어 자전거를 타거나 교통, 건설 현장 또는 철로 근처에서 걷는 동안에는 주변의 소리를 듣지 못하면 본인 또는 타인에게 위험을 초래할 수 있으므로, 이럴 경우 노이즈 캔슬링 모드를 끈 상태로 헤드폰을 사용하지 마시고, 헤드폰 사용에 관한 해당 법률을 준수하십시오.
 - 헤드폰을 끄거나 노이즈 캔슬링을 끈 상태로 헤드폰을 사용하고, 경보와 경고 신호를 포함한 주변 소리를 들을 수 있을 정도로 볼륨을 조정하십시오.
 - 헤드폰 사용 중에는 인식(Aware) 모드를 사용하더라도 주의해야 할 신호음 또는 경고음이 이상한 소리로 들릴 수 있음에 유의해야 합니다.
- 헤드폰에서 큰 이상한 소음이 들릴 경우 사용하지 마십시오. 그럴 경우 헤드폰을 끄고 Bose 고객 서비스 센터에 문의하십시오.
- 따뜻하게 느껴지거나 오디오가 손실될 경우 헤드폰을 즉시 분리하십시오.
- 과열로 인해 인적 상해 또는 재산상의 손상이 발생할 수 있으니, 휴대용 어댑터를 헤드폰과 항공기 좌석 잭에 연결하여 사용하지 마십시오.
- 헤드폰을 항공 통신 헤드셋으로 사용하지 마십시오.



질식 위험이 발생할 수 있는 소형 부품을 포함하고 있습니다. 3세 미만의 어린이가 사용하기에 부적합합니다.



이 제품에는 자석 재질이 포함되어 있습니다. 사용자의 몸에 이식한 의료 기기에 줄 수 있는 영향에 관해서는 의사에게 문의하십시오.

- 화재나 감전의 위험을 줄이려면 이 제품을 비, 물방울, 튀기는 물이나 습기에 노출시키지 말고 꽃병과 같이 액체가 채워진 물건을 제품 위나 근처에 두지 마십시오.
- 제품을 불 또는 열원에서 멀리 합니다. 촛불과 같은 무방비 상태의 불꽃을 제품 위나 근처에 두지 마십시오.
- 이 제품에는 지역 법규 요건을 만족하는 인증기관이 허가한 LPS 전원 공급장치만 사용하십시오(예: UL, CSA, VDE, CCC).
- 이 제품에 허가없이 변경을 가하지 마십시오.
- 배터리가 누출될 경우 액체가 피부나 눈이 닿지 않도록 주의하십시오. 닿았을 경우 의사의 도움을 받으십시오.
- 배터리가 들어 있는 제품을 고온(예: 직사광선, 열원 근처)에 노출하지 마십시오.
- 충전하는 동안에는 착용하지 마십시오.

참고: 이 장치는 시험 결과 FCC 규정 15부에 근거한 B급 디지털 장치에 대한 제한을 준수합니다. 이러한 제한은 거주 지역에 설치할 때 발생하는 유해한 방해 전파를 적절한 수준에서 방지할 목적으로 만들었습니다. 이 장치는 전파 에너지를 생성하고 사용하고 방출할 수 있습니다. 지침에 따라 올바르게 설치 및 사용하지 않은 경우에는 무선 통신에 대한 유해한 방해 전파를 일으킬 수도 있습니다. 그러나 특정 설치에서 방해 전파가 발생하지 않는다고 보장할 수는 없습니다. 이 장치를 켜거나 끌 때 라디오 또는 텔레비전 수신에 유해한 방해 전파를 발생시키는 경우 다음 방법 중 하나로 방해 전파를 제거할 수 있습니다.

- 제품 또는 안테나의 방향 또는 위치를 조정합니다.
- 장치와 수신기 사이의 공간을 늘립니다.
- 장비를 수신기가 연결된 것과 다른 회로의 전기 소켓에 연결합니다.
- 판매업체 또는 숙련된 라디오/TV 기술자에게 도움을 요청합니다.

Bose Corporation에서 명시적으로 승인하지 않은 변경 또는 수정은 이 장비를 작동할 수 있는 사용자의 권한을 무효화할 수 있습니다.

이 장치는 FCC 규정 15부 및 ISED 캐나다 라이선스 면제 RSS 표준을 준수합니다. 다음 두 상태에서 작동되어야 합니다. (1) 이 장치는 유해한 방해 전파를 일으키지 않으며 (2) 장치의 오작동을 일으킬 수 있는 방해 전파를 포함하여 수신되는 모든 방해 전파를 수용해야 합니다.

이 장치는 일반 대중을 위해 규정된 FCC 및 ISED 캐나다 방사 물질 노출 제한을 준수합니다. 이 송신기는 다른 안테나 또는 송신기를 함께 설치하거나 작동해서는 안 됩니다.

IMDA 요구사항을 만족합니다.

FCC ID: A94437310

IC: 3232A-437310

CAN ICES-3(B)/NMB-3(B)

유형:

작동 주파수 밴드: 2400 - 2483.5MHz.

최대 전송 출력: 20dBm EIRP 미만.

최대 전송 출력은 규정 한계 미만이기 때문에 SAR 테스트가 필요하지 않고 해당 규정에 따라 면제됩니다.



이 표시는 제품을 가정용 쓰레기처럼 폐기해서는 안 되며 적합한 수거 시설에 보내 재활용해야 함을 의미합니다. 올바른 폐기와 재생을 통해 천연 자원, 인류 건강 및 환경을 보호하는 데 일조할 수 있습니다. 이 제품의 폐기 및 재생에 대한 자세한 정보는 지방자치체, 폐기물 수거 업체 또는 이 제품을 구입한 매장에 문의하십시오.

저출력 RF 장치의 기술 규정

NCC의 허락 없이 어떤 회사, 기업 또는 사용자도 저출력 RF 장치에서 주파수 변경, 전송 출력 향상 또는 원래 특성과 성능을 변경해서는 안 됩니다. 저출력 RF 장치는 항공기 보안에 영향을 주고 법적 통신을 방해해서는 안 됩니다. 그런 경우가 발견될 경우 사용자는 방해가 발생하지 않을 때까지 즉시 작동을 멈추어야 합니다. 언급한 법적 통신은 전자통신관리법을 준수하여 발생하는 무선 통신을 말합니다. 저출력 RF 장치는 법적 통신 또는 ISM 전파 방사 장치의 방해 전파를 수용해야 합니다.

본 제품에서 리튬-이온 배터리를 **제거하려 하지 마십시오**. 제거에 대해서는 가까운 Bose 판매업체 또는 기타 유자격 전문가에게 문의하십시오.

이 제품의 충전형 리튬 이온 배터리 제거는 유자격 전문가만 수행할 수 있습니다. 자세한 내용은 인근 Bose 판매업체에 문의하거나 products.bose.com/static/compliance/index.html에서 확인하십시오.



사용한 배터리는 현지 규정에 따라 적절히 폐기하십시오. 배터리를 소각하지 마십시오.



유해 물질의 명칭 및 농도						
부품 번호	유해 물질					
	납(Pb)	수은(Hg)	카드뮴(Cd)	6가 크롬(VI)	폴리브롬화 바이페닐(PBB)	폴리브롬화 디페닐에테르(PBDE)
폴리염화 바이페닐(PCB)	X	0	0	0	0	0
금속 부품	X	0	0	0	0	0
플라스틱 부품	0	0	0	0	0	0
스피커	X	0	0	0	0	0
케이블	X	0	0	0	0	0
본 표는 SJ/T 11364 조항에 따라 준비되었습니다. 0: 이 부품의 모든 동종 재질에 함유된 이 유해 물질이 GB/T 26572에서 규정한 제한 요구사항 미만임을 나타냅니다. X: 이 부품에 사용된 동종 재질 중 최소한 하나에 함유된 이 유해 물질이 GB/T 26572에서 규정한 제한 요구사항을 초과함을 의미합니다.						

제조일: 일련 번호의 여덟 번째 자리는 제조연도를 나타냅니다. 즉 “2”는 2012년 또는 2022년입니다.

중국 수입업체: Bose Electronics (Shanghai) Company Limited, Level 6, Tower D, No. 2337 Gudai Rd. Minhang District, Shanghai 201100

EU 수입업체: Bose Products B.V., Gorslaan 60, 1441 RG Purmerend, The Netherlands

멕시코 수입업체: Bose de México S. de R.L. de C.V., Avenida Prado Sur #150, Piso 2, Interior 222 y 223, Colonia Lomas de Chapultepec V Sección, Miguel Hidalgo, Ciudad de México, C.P. 11000 전화 번호: +5255 (5202) 3545

대만 수입업체: Bose Limited Taiwan Branch (H.K.), 9F., No. 10, Sec. 3, Minsheng E. Road, Zhongshan Dist. Taipei City 10480, Taiwan 전화 번호: +886-2-2514 7676

영국 수입업체: Bose Limited, Bose House, Quayside Chatham Maritime, Chatham, Kent, ME4 4QZ, United Kingdom

입력 정격: 5V --- 0.5A

충전 온도 범위: 0°C-45°C

방전 온도 범위: -20°C-60°C

모델 437310. CMIIT ID는 이어컵 안쪽 면포 아래에 위치해 있습니다.

기록용으로 작성하여 보관하십시오.

일련 번호 및 모델 번호는 이어컵 안쪽 면포 아래에 위치해 있습니다.

일련 번호: _____

모델 번호: _____

영수증을 사용자 안내서와 함께 보관하십시오. 지금 Bose 제품을 등록하시는 것이 좋습니다. [worldwide.bose.com/ProductRegistration](https://www.worldwide.bose.com/ProductRegistration)에서 쉽게 등록할 수 있습니다.

보안 정보



이 제품은 Bose Music 앱에 연결되었을 때 Bose에서 자동으로 보안 업데이트를 수신할 수 있습니다. 모바일 응용 프로그램을 통해 보안 업데이트를 수신하려면 Bose Music 앱에서 제품 설치 프로세스를 완료해야 합니다. **설치 프로세스를 완료하지 않을 경우 Bose에서 btu.Bose.com을 통해 제공하는 보안 업데이트를 설치할 책임이 사용자에게 있습니다.**

Apple, Apple 로고, iPad, iPhone 및 iPod는 미국과 기타 국가에 등록된 Apple Inc.의 상표입니다. App Store는 Apple Inc.의 서비스 마크입니다. 상표 “iPhone”은 일본에서 Aiphone K.K.와의 사용권 계약에 따라 사용됩니다.

Made for Apple 배지를 사용하는 것은 부속품이 배지에 식별된 Apple 제품을 특별히 연결하기 위해 제작되었으며, 개발자에게서 Apple 성능 표준을 만족한다는 인증을 받았음을 의미합니다. Apple은 이 장치의 작동 또는 안전 및 규제 표준의 준수에 대한 책임이 없습니다.

Bluetooth® 단어 표시와 로고는 Bluetooth SIG, Inc.가 소유한 등록 상표이며 Bose Corporation은 사용권 계약에 따라 해당 표시를 사용합니다.

Google Play는 Google LLC의 상표입니다.

USB Type-C® 및 USB-C®는 USB Implementers Forum의 등록 상표입니다.

Bose, Bose Home Speaker, Bose Music, Bose Music 로고, Bose Smart Soundbar, Bose Smart Speaker, Bose Soundbar, QuietComfort 및 SimpleSync는 Bose Corporation의 상표입니다.

Bose Corporation 본사: 1-877-230-5639

©2022 Bose Corporation. 사전 서면 승인 없이 본 설명서의 특정 부분을 복제, 변경, 배포 또는 사용할 수 없습니다.

The following license disclosures apply to certain third-party software packages used as components in the product.

Package: FreeRTOS

Copyright © Amazon Web Services, Inc. or its affiliates. All rights reserved.

The FreeRTOS package is subject to the license terms reprinted below:

MIT License

Permission is hereby granted, free of charge, to any person obtaining a copy of this software and associated documentation files (the "Software"), to deal in the Software without restriction, including without limitation the rights to use, copy, modify, merge, publish, distribute, sublicense, and/or sell copies of the Software, and to permit persons to whom the Software is furnished to do so, subject to the following conditions:

The above copyright notice and this permission notice shall be included in all copies or substantial portions of the Software.

THE SOFTWARE IS PROVIDED "AS IS", WITHOUT WARRANTY OF ANY KIND, EXPRESS OR IMPLIED, INCLUDING BUT NOT LIMITED TO THE WARRANTIES OF MERCHANTABILITY, FITNESS FOR A PARTICULAR PURPOSE AND NONINFRINGEMENT. IN NO EVENT SHALL THE AUTHORS OR COPYRIGHT HOLDERS BE LIABLE FOR ANY CLAIM, DAMAGES OR OTHER LIABILITY, WHETHER IN AN ACTION OF CONTRACT, TORT OR OTHERWISE, ARISING FROM, OUT OF OR IN CONNECTION WITH THE SOFTWARE OR THE USE OR OTHER DEALINGS IN THE SOFTWARE.

Package: Nanopb

Copyright © 2011 Petteri Aimonen <jpa at nanopb.mail.kapsi.fi>.

The Nanopb package is subject to the license terms reprinted below:

Zlib License

© 2011 Petteri Aimonen <jpa at nanopb.mail.kapsi.fi>

This software is provided 'as-is', without any express or implied warranty. In no event will the authors be held liable for any damages arising from the use of this software.

Permission is granted to anyone to use this software for any purpose, including commercial applications, and to alter it and redistribute it freely, subject to the following restrictions:

1. The origin of this software must not be misrepresented; you must not claim that you wrote the original software. If you use this software in a product, an acknowledgment in the product documentation would be appreciated but is not required.
2. Altered source versions must be plainly marked as such, and must not be misrepresented as being the original software.
3. This notice may not be removed or altered from any source distribution.

Package: Mbed TLS 2.16.1

© ARM Limited. All rights reserved.

The Mbed TLS package is subject to the license terms reprinted below:

Apache License

Version 2.0, January 2004

<http://www.apache.org/licenses/>

TERMS AND CONDITIONS FOR USE, REPRODUCTION, AND DISTRIBUTION

1. Definitions.

"License" shall mean the terms and conditions for use, reproduction, and distribution as defined by Sections 1 through 9 of this document.

“Licensor” shall mean the copyright owner or entity authorized by the copyright owner that is granting the License.

“Legal Entity” shall mean the union of the acting entity and all other entities that control, are controlled by, or are under common control with that entity. For the purposes of this definition, “control” means (i) the power, direct or indirect, to cause the direction or management of such entity, whether by contract or otherwise, or (ii) ownership of fifty percent (50%) or more of the outstanding shares, or (iii) beneficial ownership of such entity.

“You” (or “Your”) shall mean an individual or Legal Entity exercising permissions granted by this License.

“Source” form shall mean the preferred form for making modifications, including but not limited to software source code, documentation source, and configuration files.

“Object” form shall mean any form resulting from mechanical transformation or translation of a Source form, including but not limited to compiled object code, generated documentation, and conversions to other media types.

“Work” shall mean the work of authorship, whether in Source or Object form, made available under the License, as indicated by a copyright notice that is included in or attached to the work (an example is provided in the Appendix below).

“Derivative Works” shall mean any work, whether in Source or Object form, that is based on (or derived from) the Work and for which the editorial revisions, annotations, elaborations, or other modifications represent, as a whole, an original work of authorship. For the purposes of this License, Derivative Works shall not include works that remain separable from, or merely link (or bind by name) to the interfaces of, the Work and Derivative Works thereof.

“Contribution” shall mean any work of authorship, including the original version of the Work and any modifications or additions to that Work or Derivative Works thereof, that is intentionally submitted to Licensor for inclusion in the Work by the copyright owner or by an individual or Legal Entity authorized to submit on behalf of the copyright owner. For the purposes of this definition, “submitted” means any form of electronic, verbal, or written communication sent to the Licensor or its representatives, including but not limited to communication on electronic mailing lists, source code control systems, and issue tracking systems that are managed by, or on behalf of, the Licensor for the purpose of discussing and improving the Work, but excluding communication that is conspicuously marked or otherwise designated in writing by the copyright owner as “Not a Contribution.”

“Contributor” shall mean Licensor and any individual or Legal Entity on behalf of whom a Contribution has been received by Licensor and subsequently incorporated within the Work.

2. Grant of Copyright License. Subject to the terms and conditions of this License, each Contributor hereby grants to You a perpetual, worldwide, non-exclusive, no-charge, royalty-free, irrevocable copyright license to reproduce, prepare Derivative Works of, publicly display, publicly perform, sublicense, and distribute the Work and such Derivative Works in Source or Object form.
3. Grant of Patent License. Subject to the terms and conditions of this License, each Contributor hereby grants to You a perpetual, worldwide, non-exclusive, no-charge, royalty-free, irrevocable (except as stated in this section) patent license to make, have made, use, offer to sell, sell, import, and otherwise transfer the Work, where such license applies only to those patent claims licensable by such Contributor that are necessarily infringed by their Contribution(s) alone or by combination of their Contribution(s) with the Work to which such Contribution(s) was submitted. If You institute patent litigation against any entity (including a cross-claim or counterclaim in a lawsuit) alleging that the Work or a Contribution incorporated within the Work constitutes direct or contributory patent infringement, then any patent licenses granted to You under this License for that Work shall terminate as of the date such litigation is filed.
4. Redistribution. You may reproduce and distribute copies of the Work or Derivative Works thereof in any medium, with or without modifications, and in Source or Object form, provided that You meet the following conditions:
 - a. You must give any other recipients of the Work or Derivative Works a copy of this License; and
 - b. You must cause any modified files to carry prominent notices stating that You changed the files; and
 - c. You must retain, in the Source form of any Derivative Works that You distribute, all copyright, patent, trademark, and attribution notices from the Source form of the Work, excluding those notices that do not pertain to any part of the Derivative Works; and

d. If the Work includes a “NOTICE” text file as part of its distribution, then any Derivative Works that You distribute must include a readable copy of the attribution notices contained within such NOTICE file, excluding those notices that do not pertain to any part of the Derivative Works, in at least one of the following places: within a NOTICE text file distributed as part of the Derivative Works; within the Source form or documentation, if provided along with the Derivative Works; or, within a display generated by the Derivative Works, if and wherever such third-party notices normally appear. The contents of the NOTICE file are for informational purposes only and do not modify the License. You may add Your own attribution notices within Derivative Works that You distribute, alongside or as an addendum to the NOTICE text from the Work, provided that such additional attribution notices cannot be construed as modifying the License.

You may add Your own copyright statement to Your modifications and may provide additional or different license terms and conditions for use, reproduction, or distribution of Your modifications, or for any such Derivative Works as a whole, provided Your use, reproduction, and distribution of the Work otherwise complies with the conditions stated in this License.

5. Submission of Contributions. Unless You explicitly state otherwise, any Contribution intentionally submitted for inclusion in the Work by You to the Licensor shall be under the terms and conditions of this License, without any additional terms or conditions. Notwithstanding the above, nothing herein shall supersede or modify the terms of any separate license agreement you may have executed with Licensor regarding such Contributions.
6. Trademarks. This License does not grant permission to use the trade names, trademarks, service marks, or product names of the Licensor, except as required for reasonable and customary use in describing the origin of the Work and reproducing the content of the NOTICE file.
7. Disclaimer of Warranty. Unless required by applicable law or agreed to in writing, Licensor provides the Work (and each Contributor provides its Contributions) on an “AS IS” BASIS, WITHOUT WARRANTIES OR CONDITIONS OF ANY KIND, either express or implied, including, without limitation, any warranties or conditions of TITLE, NON-INFRINGEMENT, MERCHANTABILITY, or FITNESS FOR A PARTICULAR PURPOSE. You are solely responsible for determining the appropriateness of using or redistributing the Work and assume any risks associated with Your exercise of permissions under this License.
8. Limitation of Liability. In no event and under no legal theory, whether in tort (including negligence), contract, or otherwise, unless required by applicable law (such as deliberate and grossly negligent acts) or agreed to in writing, shall any Contributor be liable to You for damages, including any direct, indirect, special, incidental, or consequential damages of any character arising as a result of this License or out of the use or inability to use the Work (including but not limited to damages for loss of goodwill, work stoppage, computer failure or malfunction, or any and all other commercial damages or losses), even if such Contributor has been advised of the possibility of such damages.
9. Accepting Warranty or Additional Liability. While redistributing the Work or Derivative Works thereof, You may choose to offer, and charge a fee for, acceptance of support, warranty, indemnity, or other liability obligations and/or rights consistent with this License. However, in accepting such obligations, You may act only on Your own behalf and on Your sole responsibility, not on behalf of any other Contributor, and only if You agree to indemnify, defend, and hold each Contributor harmless for any liability incurred by, or claims asserted against, such Contributor by reason of your accepting any such warranty or additional liability.

END OF TERMS AND CONDITIONS

©2022 Bose Corporation

Licensed under the Apache License, Version 2.0 (the “License”); you may not use this file except in compliance with the License.

You may obtain a copy of the License at: <http://www.apache.org/licenses/LICENSE-2.0>

Unless required by applicable law or agreed to in writing, software distributed under the License is distributed on an “AS IS” BASIS, WITHOUT WARRANTIES OR CONDITIONS OF ANY KIND, either express or implied.

See the License for the specific language governing permissions and limitations under the License.

상자 내용물

내용물	13
-----------	----

BOSE MUSIC 앱

Bose Music 앱 다운로드	14
기존 계정에 헤드폰 추가	14

헤드폰 콘트롤

전원 켜기	16
대기 타이머	16
전원 끄기	17
헤드폰 기능	18
미디어 재생 및 볼륨	18
전화 통화	19
실행 버튼	20

노이즈 캔슬링

노이즈 캔슬링 모드	21
노이즈 캔슬링 모드 변경	21

음성 제어

음성 제어 사용	22
----------------	----

BLUETOOTH® 연결

모바일 장치의 Bluetooth 메뉴를 사용한 연결	23
모바일 장치 연결 해제	25
모바일 장치 재연결	25
다른 모바일 장치 연결	25
연결된 모바일 장치 식별	25
연결된 모바일 장치 두 대 사이 전환	25
이전에 연결된 장치 다시 연결	26
헤드폰 장치 목록 소거	26

유선 연결

오디오 케이블 연결	27
------------------	----

배터리

헤드폰 충전	28
충전 시간.....	28
배터리 잔량 음성 안내.....	28

헤드폰 상태

<i>Bluetooth</i> 상태	29
배터리 상태	29
충전 상태	30
업데이트 및 오류 상태	30

BOSE 제품 연결

Bose Smart Speaker 또는 Soundbar 연결	31
이점	31
호환되는 제품.....	31
Bose Music 앱을 사용한 연결	31
Bose Smart Speaker 또는 Soundbar 다시 연결	32

보관 및 유지보수

헤드폰 보관.....	33
헤드폰 청소.....	34
교체용 부품 및 부속품	34
제한 보증	34
일련 번호 위치	35

문제 해결

이 방법을 먼저 시도하십시오..... 36
기타 방법..... 36
공장 설정으로 헤드폰 복원..... 39

내용물

다음 부품들이 포함되어 있는지 확인합니다.



Bose QuietComfort 45 headphones

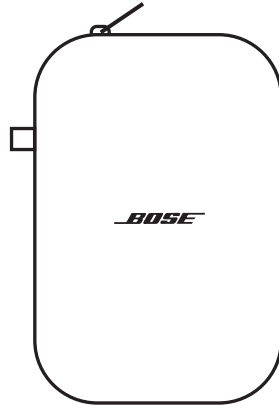

소프트 케이스

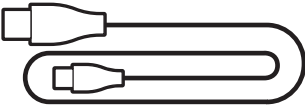

USB Type-C® 케이블

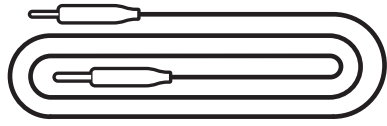

3.5mm 대 2.5mm 변환 오디오 케이블

참고: 제품 일부가 손상된 경우 사용하지 마십시오. 공인 Bose 판매업체 또는 Bose 고객 서비스 센터에 문의하십시오.

support.Bose.com/QCSE에서 확인하십시오.

Bose Music 앱을 사용하면 스마트폰 또는 태블릿과 같은 모바일 장치에서 헤드폰을 설정하고 조작할 수 있습니다.

앱을 사용하여 *Bluetooth* 연결을 관리하고 헤드폰 설정을 관리하고 음성 안내 언어를 선택하고 업데이트를 통해 새로운 기능에 액세스할 수 있습니다.

참고: 다른 Bose 제품에서 Bose Music 계정을 이미 만들었다면 기존 계정에 헤드폰을 추가합니다(14페이지 하단 참조).

BOSE MUSIC 앱 다운로드

1. 모바일 장치에서 Bose Music 앱을 다운로드합니다.

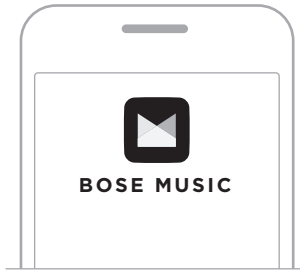

2. 앱 지침을 따릅니다.

기존 계정에 헤드폰 추가

Bose QuietComfort 45 헤드폰을 추가하려면 Bose Music 앱을 열고 헤드폰을 추가합니다.



전원 켜기

오른쪽 이어컵에서 전원/*Bluetooth* 스위치를 오른쪽으로 밀니다.

음성 안내가 배터리 잔량을 알리며 상태 표시등이 현재 충전 잔량에 따라 들어옵니다 (29페이지 참조).



대기 타이머

대기 타이머는 헤드폰을 사용하지 않을 때 배터리 전력을 보존합니다.

대기 타이머를 설정하고 사용자 지정하려면 Bose Music 앱을 사용합니다.

전원 끄기

전원/*Bluetooth* 스위치를 왼쪽으로 밀니다.



참고: 헤드폰을 끄면 노이즈 캔슬링이 사용 해제됩니다.

헤드폰 기능

헤드폰 콘트롤은 오른쪽 이어컵의 뒷면에 위치해 있습니다.

미디어 재생 및 볼륨

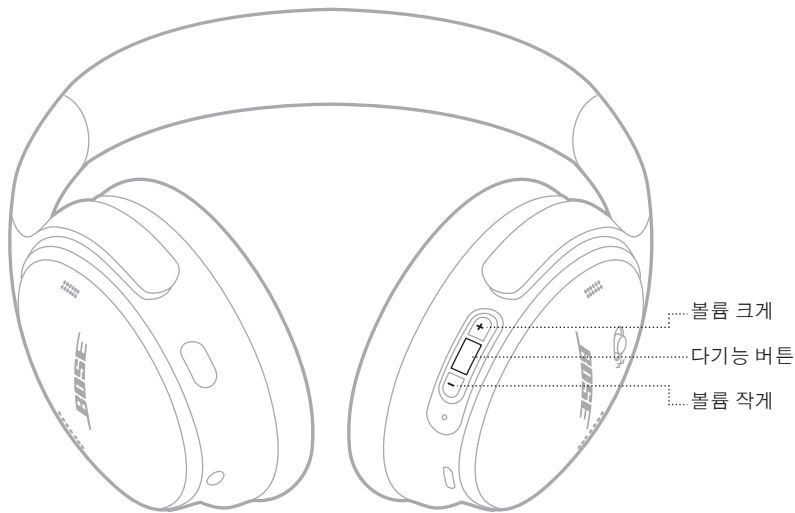

기능	해결 방법
재생/일시 중지	다기능 버튼을 누릅니다.
앞으로 건너뛰기	다기능 버튼을 두 번 누릅니다.
뒤로 건너뛰기	다기능 버튼을 세 번 누릅니다.
볼륨 크게	+를 누릅니다.
볼륨 작게	-를 누릅니다.

참고:

- 볼륨을 빨리 올리려면 +를 길게 누릅니다.
- 볼륨을 빨리 내리려면 -를 길게 누릅니다.

전화 통화

다기능 버튼은 오른쪽 이어컵 뒷면에 위치해 있습니다. 마이크는 오른쪽 이어컵의 전면 근처에 위치해 있습니다.

실행 버튼은 왼쪽 이어컵 뒷면에 위치해 있습니다.

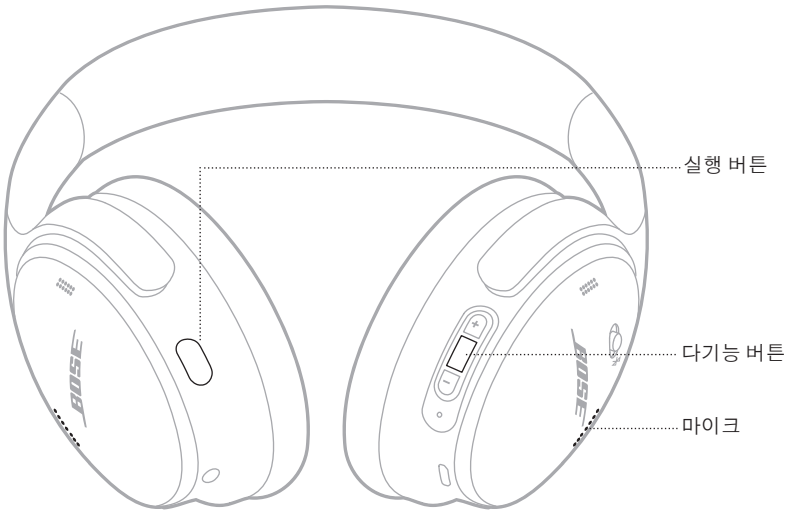

기능

해결 방법

통화/종료	다기능 버튼을 누릅니다.
걸려오는 전화 거부	다기능 버튼을 1초간 길게 누릅니다.
두 번째로 걸려온 전화를 받고 현재 통화 대기	통화 중에 두 번째로 걸려온 전화의 벨 소리가 들리면 다기능 버튼을 누릅니다.
두 번째 걸려온 통화를 거부하고 현재 통화 계속	통화 중에 두 번째로 걸려온 전화의 벨 소리가 들리면 다기능 버튼을 1초간 길게 누릅니다.
두 통화 사이 전환	두 통화가 활성화된 상태에서 다기능 버튼을 두 번 누릅니다.
회의 통화 만들기	두 통화가 활성화된 상태에서 다기능 버튼을 3초간 길게 누릅니다.
통화 음소거/음소거 해제	통화 중에 실행 버튼을 두 번 누릅니다.

실행 버튼

실행 버튼을 사용하면 여러 노이즈 캔슬링 모드 간을 빠르고 쉽게 전환할 수 있습니다.

실행 버튼은 왼쪽 이어컵 뒷면에 위치해 있습니다.

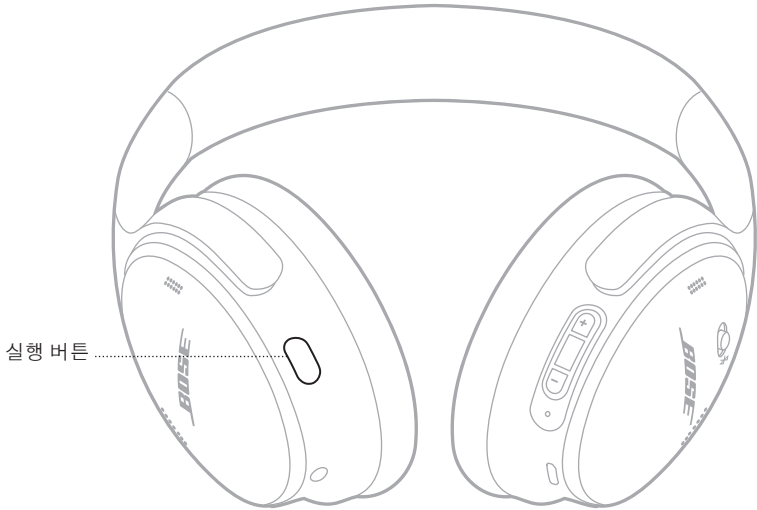

노이즈 캔슬링 켜짐과 꺼짐 사이를 전환하려면 실행 버튼을 누릅니다.

노이즈 캔슬링 모드에 대한 자세한 내용은 21페이지를 참조하십시오.

노이즈 캔슬링 기능은 원치 않는 노이즈를 감소시켜 더 명료하고 더 생동감 있는 오디오 성능을 제공합니다. 다음과 같이 두 노이즈 캔슬링 모드 중에서 선택할 수 있습니다. 노이즈 캔슬링 켜짐 및 노이즈 캔슬링 꺼짐.

노이즈 캔슬링 켜짐 모드를 사용하면 가장 높은 수준의 노이즈 캔슬링을 사용하여 산만함을 차단할 수 있습니다.

노이즈 캔슬링 꺼짐 모드는 모든 주변음을 허용하기 때문에 오디오를 즐기면서 주변의 모든 소리를 들을 수 있습니다.

청취 기호와 환경에 따라 노이즈 캔슬링 모드를 선택합니다.

노이즈 캔슬링 모드

모드	설명
노이즈 캔슬링 켜짐	Bose 최적화 오디오를 사용한 정상급 노이즈 캔슬링
노이즈 캔슬링 꺼짐	오디오를 즐기면서 주변의 모든 소리를 들었습니다.

참고: 전원이 켜지면 헤드폰이 마지막으로 사용했던 모드를 사용합니다.

노이즈 캔슬링 모드 변경

노이즈 캔슬링 모드를 변경하려면 실행 버튼을 누릅니다.

음성 안내가 선택한 노이즈 캔슬링 모드를 알립니다.

팁: Bose Music 앱을 사용해서도 노이즈 캔슬링 모드를 변경할 수 있습니다.

음성 제어 사용

헤드폰을 사용하여 모바일 장치의 음성 제어에 액세스할 수 있습니다. 음성 제어에 액세스하려면 다기능 버튼을 1초간 길게 누릅니다.

다기능 버튼은 오른쪽 이어컵 뒷면에 위치해 있습니다.

참고: 통화 중에는 음성 제어를 이용할 수 없습니다.

모바일 장치의 **BLUETOOTH** 메뉴를 사용한 연결

헤드폰 장치 목록에 최대 8대의 연결된 장치를 저장할 수 있으며 헤드폰은 한 번에 두 대의 장치에 활성 연결할 수 있습니다. 한 번에 한 모바일 장치에서만 오디오를 재생할 수 있습니다.

참고: 활용도를 높이려면 Bose Music 앱을 사용하여 모바일 장치를 설치하고 연결합니다(14페이지 참조).

1. 전원/*Bluetooth* 스위치를 오른쪽 으로 밀고 3초간 그대로 유지합니다.

“연결할 준비가 되었습니다.”가 들리고 상태 표시등이 청색 불을 깜박입니다.



2. 장치에서 Bluetooth 기능을 사용 설정합니다.

참고: Bluetooth 기능은 대개 설정 메뉴에서 찾을 수 있습니다.

3. 장치 목록에서 헤드폰을 선택합니다.

팁: Bose Music 앱에서 헤드폰으로 입력한 이름을 찾습니다. 헤드폰 이름을 지정하지 않은 경우 기본 이름이 나타납니다.



연결되면 “<장치 이름>에 연결되었습니다.”가 들리고 상태 표시등에 청색 불이 10초간 들어옵니다.

모바일 장치 연결 해제

Bose Music 앱을 사용하여 모바일 장치를 연결 해제합니다.

팁: *Bluetooth* 설정을 사용해서도 장치를 연결 해제할 수 있습니다. *Bluetooth* 기능을 사용 해제하면 다른 모든 장치가 연결 해제됩니다.

모바일 장치 재연결

전원을 켜면 헤드폰이 가장 최근에 연결되었던 장치 두 대에 다시 연결을 시도합니다.

참고:

- 장치가 수신 범위 내(9m)에 있고 전원이 켜져 있어야 합니다.
- 모바일 장치에서 *Bluetooth* 기능이 사용 설정되어 있는지 확인합니다.

다른 모바일 장치 연결

또 다른 장치를 연결하려면 Bose Music 앱을 다운로드(14페이지 참조)하거나 모바일 장치에서 *Bluetooth* 메뉴(23페이지 참조)를 사용합니다.

참고: 하지만 한 번에 장치 한 대에서만 음악을 재생할 수 있습니다.

연결된 모바일 장치 식별

전원/*Bluetooth* 스위치를 오른쪽 *으로 밀었다 놓으면 현재 연결된 장치 이름이 들립니다.

연결된 모바일 장치 두 대 사이 전환

1. 첫째 모바일 장치에서 오디오를 일시 중지합니다.
2. 둘째 모바일 장치에서 오디오를 실행합니다.

참고: 헤드폰은 어떤 장치에서 오디오를 재생 중이든 두 장치 모두에서 전화를 수신할 수 있습니다.

이전에 연결된 장치 다시 연결

1. 전원/*Bluetooth* 스위치를 오른쪽 *으로 밀었다 놓으면 연결된 장치 이름이 들립니다.
2. 2초 내에 전원/*Bluetooth* 스위치를 오른쪽 *으로 다시 밀었다 놓으면 헤드폰 장치 목록의 다음 장치에 연결됩니다.
3. 올바른 장치 이름이 들릴 때까지 반복합니다.
장치가 연결되면 연결되었음을 알리는 신호음이 들립니다.
4. 연결된 모바일 장치에서 오디오를 실행합니다.

참고: 두 개의 장치가 이미 헤드폰에 연결된 경우 새로 연결된 장치가 이전에 연결된 두 번째 장치를 대체합니다.

헤드폰 장치 목록 소거

1. "*Bluetooth* 장치 목록이 제거되었습니다. 연결 준비가 되었습니다."가 들릴 때까지 전원/*Bluetooth* 스위치를 오른쪽 *으로 밀고 15초간 그대로 유지합니다.
2. 모바일 장치의 *Bluetooth* 목록에서 헤드폰을 제거합니다.
모든 장치가 소거되고 헤드폰이 연결 준비됩니다.

오디오 케이블 연결

2.5mm 대 3.5mm 변환 케이블을 사용하여 비무선 장치에 연결하거나 배터리가 완전히 방전된 경우 헤드폰 사용을 계속합니다.

1. 케이블을 왼쪽 이어컵의 2.5mm 포트에 연결합니다.



2. 케이블의 반대쪽을 장치의 3.5mm 포트에 연결합니다.

참고: 오디오 케이블이 연결된 경우 헤드폰 전원을 켜거나 끈 상태 모두에서 사용할 수 있습니다.

헤드폰 충전

1. USB 케이블의 작은 쪽을 오른쪽 이어컵의 USB-C 포트에 연결합니다.
2. 반대 쪽을 USB 콘센트용 충전기에 연결합니다.

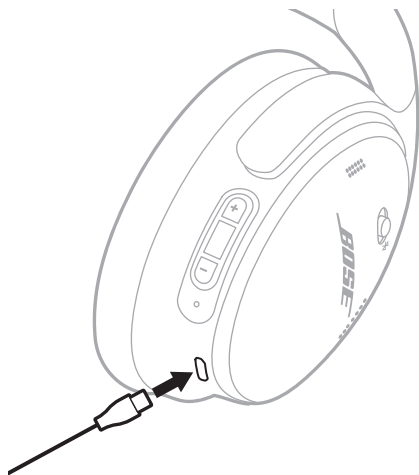

참고:

- 헤드폰이 충전이 필요하면 상태 표시등에 백색 불이 10초간 깜박입니다. 완전 충전되면 상태 표시등에 백색 불이 들어옵니다.
- 헤드폰은 충전 중에 오디오를 재생하지 않습니다.

충전 시간

헤드폰을 완전히 충전하려면 최대 2시간 충전합니다.

배터리 잔량 음성 안내

헤드폰 전원을 켤 때마다 배터리 잔량을 알리는 음성 안내가 들립니다. 헤드폰 배터리 잔량이 적은 경우 “배터리가 약합니다. 지금 충전하십시오.”가 들립니다.

참고: 배터리 충전 상태를 눈으로 확인하려면 오른쪽 이어컵에 위치한 표시등을 확인하십시오. 자세한 내용은 29페이지의 “배터리 상태”를 참조하십시오.

상태 표시등은 오른쪽 이어컵에 위치해 있습니다.



BLUETOOTH 상태

Bluetooth 연결 상태를 표시합니다.

표시등 동작	시스템 상태
청색 점멸	연결 준비됨
청색 점등(10초)	연결됨

배터리 상태

배터리 잔량을 표시합니다.

표시등 동작	시스템 상태
백색 점등	중간-완전 충전
주황색 점등	낮은 충전

팁: Bose Music 앱을 사용해서도 배터리 잔량을 확인할 수 있습니다.

충전 상태

충전 상태를 표시합니다.

표시등 동작	시스템 상태
백색 2회 점멸	충전 시작됨
주황색 점등	충전 중
백색 점등	완전 충전

업데이트 및 오류 상태

업데이트 또는 오류 상태를 표시합니다.

표시등 동작	시스템 상태
백색 빠른 점멸(10초)	소프트웨어 업데이트 중(USB 연결)
백색 느린 점멸(30-60초)	소프트웨어 업데이트 중(무선 연결)
주황색 및 백색 점멸	오류 - Bose 고객 서비스 센터에 문의하십시오

BOSE SMART SPEAKER 또는 SOUNDBAR 연결

SimpleSync™ 기술을 사용하면 헤드폰을 Bose Smart Soundbar 또는 Bose Smart Speaker에 연결하여 개인적인 청취 환경을 만들 수 있습니다.

이점

- 헤드폰을 원하는 볼륨으로 유지하면서 각 제품의 독립적인 볼륨 컨트롤을 사용하여 Bose Smart Soundbar 볼륨을 낮추거나 음소거합니다.
- 헤드폰을 Bose Smart Speaker에 연결하여 다음 룸에서 명료하게 음악을 청취합니다.

참고: SimpleSync™ 기술의 *Bluetooth* 범위는 최대 9m입니다. 벽과 구조재가 수신에 영향을 줄 수 있습니다.

호환되는 제품

헤드폰을 다른 Bose Smart Speaker 또는 Bose Smart Soundbar와 연결할 수 있습니다.

많이 사용하는 호환 제품은 다음과 같습니다.

- Bose Smart Soundbar 700/Bose Soundbar 700
- Bose Soundbar 500
- Bose Smart Speaker 500/Bose Home Speaker 500
- Bose Home Speaker 300
- Bose Portable Smart Speaker/Bose Portable Home Speaker

새로운 제품이 주기적으로 출시됩니다. 전체 목록과 자세한 정보는 다음에서 확인하십시오. worldwide.Bose.com/Support/Groups

Bose Music 앱을 사용한 연결

1. 헤드폰에서 전원/*Bluetooth* 스위치를 오른쪽 으로 밀고 3초간 그대로 유지합니다.
“다른 장치와 연결할 준비가 되었습니다.”가 들리고 상태 표시등이 청색 불을 깜박입니다.
2. Bose Music 앱을 사용하여 헤드폰을 호환 Bose 제품에 연결합니다. 자세한 내용은 다음에서 확인하십시오. worldwide.Bose.com/Support/Groups

참고:

- 헤드폰은 사운드바 또는 스피커에서 9m 이내에서 사용해야 합니다
- 헤드폰은 한번에 제품 한 대만 연결할 수 있습니다.

BOSE SMART SPEAKER 또는 SOUNDBAR 다시 연결

헤드폰 전원을 켭니다(16페이지의 “전원 켜기” 참조).

헤드폰은 사운드바나 스피커를 포함하여 가장 최근에 연결한 *Bluetooth* 장치 2대에 연결을 시도합니다.

참고:

- 사운드바나 스피커가 수신 범위 내(9m)에 있고 전원이 켜져 있어야 합니다.
- 헤드폰이 다시 연결되지 않을 경우 38페이지의 “헤드폰이 이전에 연결된 Bose Smart Soundbar 또는 Speaker에 연결되지 않을 경우”를 참조하십시오.

헤드폰 보관

이어컵은 회전시켜 쉽고 간편하게 보관할 수 있습니다. 케이스에 헤드폰을 편평하게 놓습니다.

1. 양쪽 이어컵을 편평하게 놓이도록 돌립니다.



2. 왼쪽 이어컵을 헤드밴드 쪽으로 접습니다.

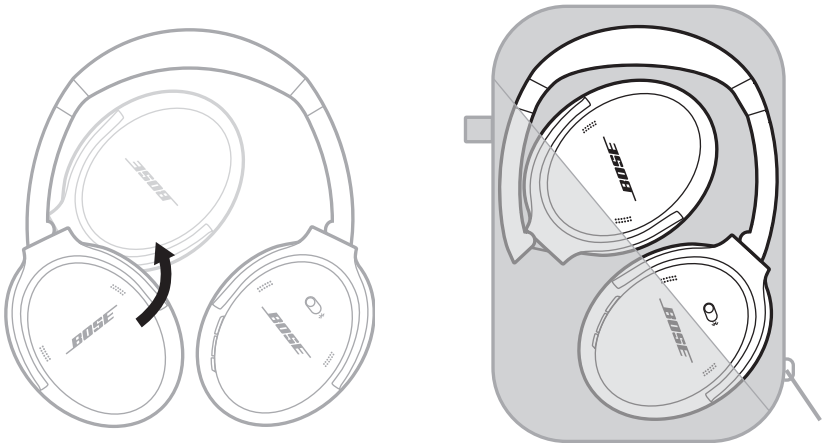

참고:

- 헤드폰을 사용하지 않을 때는 전원을 반드시 꺼두십시오.
- 몇 달 이상 헤드폰을 보관할 때는 배터리를 반드시 완전히 충전해 놓으십시오.

헤드폰 청소

부드러운 마른 헝겊으로 외부 표면을 닦아 줍니다.

이어컵에 습기가 들어가지 않도록 하십시오.

교체용 부품 및 부속품

교체용 부품 및 부속품은 Bose 고객 서비스 센터를 통해 주문하실 수 있습니다. 사용법 동영상은 다음에서 확인하십시오. support.Bose.com/QCSE

제한 보증

헤드폰은 제한 보증의 적용을 받습니다. 제한 보증에 대한 자세한 내용은 당사 웹사이트 worldwide.Bose.com/Warranty에서 확인하십시오.

제품을 등록하려면 worldwide.Bose.com/ProductRegistration에서 지침을 확인하십시오. 등록하지 않더라도 제한 보증에 대한 권리에는 영향이 없습니다.

일련 번호 위치

일련 번호는 오른쪽 이어컵 안쪽 면포 아래에 위치해 있습니다. 면포는 이어컵 내부의 구성 요소를 덮어 보호하는 안쪽의 망입니다.

일련 번호를 보려면 면포의 상단 가장자리를 잡고 부드럽게 벗깁니다.

주의: 헤드폰을 손상시킬 수 있으므로 다른 구성 요소를 누르거나 제거하지 않도록 주의하십시오.

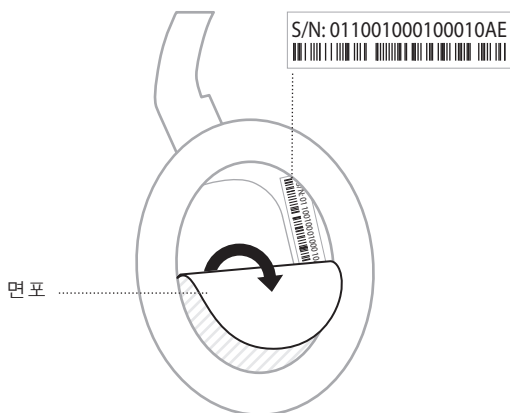

이 방법을 먼저 시도하십시오

헤드폰에 문제가 발생할 경우:

- 상태 표시등의 상태를 확인합니다(29페이지 참조).
- 배터리를 충전합니다(28페이지 참조).
- 헤드폰, 모바일 장치 및 음악 앱의 볼륨을 올립니다.
- Bose Music 앱을 다운로드하고 소프트웨어 업데이트가 있으면 실행합니다(14페이지 참조).
- 다른 모바일 장치의 페어링을 시도합니다(25페이지 참조).

문제를 해결할 수 없을 경우 아래 표에서 증상을 식별하고 흔한 문제에 대한 해결책을 확인할 수 있습니다. 문제를 해결할 수 없을 경우 Bose 고객센터 서비스 센터에 문의하십시오.

worldwide.Bose.com/contact에서 확인하십시오.

기타 방법

증상	해결책
헤드폰의 전원이 켜지지 않는 경우	배터리를 충전합니다.
헤드폰이 모바일 장치와 연결되지 않을 경우	<p>백업 오디오 케이블을 분리합니다.</p> <p>USB 충전 케이블을 분리합니다.</p> <p>모바일 장치에서:</p> <p><i>Bluetooth</i> 기능을 사용 해제했다가 다시 사용 설정합니다.</p> <p>장치의 <i>Bluetooth</i> 목록에서 LE(저에너지)로 표시된 중복 목록을 포함하여 Bose QuietComfort 45 헤드폰을 삭제합니다. 다시 연결합니다.</p> <p>모바일 장치를 헤드폰 가까이로 이동하고 다른 간섭 또는 장애물에서 벗어나십시오.</p> <p>support.Bose.com/QCSE을 방문하여 사용법 동영상을 확인합니다.</p> <p>연결 장치 목록을 소거(26페이지 참조)하고 다시 연결합니다.</p>
배터리가 충전되지 않을 경우	<p>USB 충전 케이블의 양쪽을 단단히 고정합니다.</p> <p>다른 충전 소스를 사용해봅니다.</p> <p>헤드폰이 고온 또는 저온에 노출된 경우 실온으로 되돌린 후 충전을 다시 시도합니다.</p>

증상	해결책
소리가 나지 않을 경우	<p>헤드폰 전원을 켜고 배터리를 충전합니다.</p> <p>상태 표시등의 상태를 확인합니다(29페이지 참조).</p> <p>연결된 장치를 들으려면 전원/<i>Bluetooth</i> 스위치를 오른쪽으로 밀었다가 놓습니다. 올바른 장치를 사용하고 있는지 확인합니다.</p> <p>모바일 장치를 헤드폰 가까이로 이동하고 다른 간섭 또는 장애물에서 벗어납니다.</p> <p>다른 음악 소스를 사용합니다.</p> <p>모바일 장치 2대가 연결된 경우 다른 장치를 먼저 일시 중지합니다.</p> <p>모바일 장치 2대가 연결된 경우 장치들을 헤드폰 수신 범위(9m) 내로 옮깁니다.</p> <p>모바일 장치에서 장치에 저장된 음악이나 비디오를 재생해봅니다.</p>
음질이 불량한 경우	<p>다른 음악 소스를 사용합니다.</p> <p>다른 모바일 장치를 연결합니다(25페이지 참조).</p> <p>두 번째 장치를 연결 해제합니다.</p> <p>모바일 장치를 헤드폰 가까이로 이동하고 다른 간섭 또는 장애물에서 벗어납니다.</p> <p>모바일 장치에서 장치에 저장된 음악이나 비디오를 재생해봅니다.</p>
백업 오디오 케이블로 연결된 장치에서 소리가 나지 않을 경우	<p>백업 오디오 케이블의 양쪽을 단단히 고정합니다.</p> <p>헤드폰, 모바일 장치 및 음악 소스의 볼륨을 올립니다.</p> <p>다른 장치를 연결합니다(25페이지 참조).</p>
오디오 케이블로 연결된 장치에서 나오는 사운드의 음질이 불량한 경우	<p>백업 오디오 케이블의 양쪽을 단단히 고정합니다.</p> <p>다른 장치를 연결합니다(25페이지 참조).</p>
실행 버튼이 노이즈 캔슬링 모드를 변경하지 못할 경우	<p>헤드폰 전원이 켜져 있는지 확인합니다.</p> <p>Bose Music 앱을 사용하여 노이즈 캔슬링 모드를 변경합니다.</p>

증상	해결책
헤드폰이 Bose Smart Soundbar 또는 Speaker에 연결되지 않을 경우	<p>“다른 장치를 연결할 준비가 되었습니다.”가 들리고 <i>Bluetooth</i> 표시등이 청색 불을 깜빡일 때까지 전원/<i>Bluetooth</i> 버튼을 길게 껍니다.</p> <p>헤드폰은 사운드바 또는 스피커에서 9m 이내에서 사용해야 합니다</p>
헤드폰이 이전에 연결된 Bose Smart Soundbar 또는 Speaker에 연결되지 않을 경우	<p>이전에 연결된 장치를 다시 연결합니다(26페이지 참조).</p>
Bose Smart Soundbar 또는 Speaker에 연결되었을 때 오디오가 지연될 경우	<p>Bose Music 앱을 다운로드하고 소프트웨어 업데이트가 있으면 실행합니다.</p>

공장 설정으로 복원하면 모든 설정을 지우고 헤드폰을 원래의 초기 상태로 되돌릴 수 있습니다. 그런 다음 헤드폰을 처음 설정하는 것처럼 구성할 수 있습니다.

헤드폰에 문제가 있거나 Bose 고객 서비스의 지시를 받은 경우에만 공장 설정으로 복원하는 것이 좋습니다.

공장 설정으로 헤드폰 복원

1. 장치의 *Bluetooth* 목록에서 헤드폰을 제거합니다.
2. Bose Music 앱을 사용하여 Bose 계정에서 헤드폰을 제거합니다.

참고: Bose Music 앱을 사용하여 Bose 계정에서 헤드폰을 제거하는 방법에 대한 자세한 내용은 support.bose.com/QCSE에서 확인하십시오.

3. 전원/*Bluetooth* 스위치를 오른쪽 ⌘로 밀고 그대로 유지합니다. 동시에 실행 버튼을 30초간 길게 누릅니다.
상태 표시등이 백색을 깜박입니다. 30초 후 상태 표시등이 주황색을 깜박여 공장 설정이 복원 중임을 나타냅니다(2-3초).
4. 복원이 완료되면 상태 표시등이 청색을 천천히 깜박입니다. 헤드폰은 이제 원래의 기본 상태입니다.

请阅读并保留所有安全、安全性和使用说明。

 Bose Corporation 在此声明，本产品严格遵守 2014/53/EU 指令和其他所有适用的欧盟指令要求中的基本要求和和其他相关规定。符合声明全文载于：www.Bose.com/compliance

 本产品符合所有适用的 2016 电磁兼容性法规和所有其他适用的英国法规。符合声明全文载于：www.Bose.com/compliance

Bose Corporation 在此声明，本产品严格遵守 2017 无线电设备法规的基本要求和所有其他适用的英国法规。符合声明全文载于：www.Bose.com/compliance

重要安全说明

请勿在水附近使用本设备。

请仅用干布进行清洁。

任何维修事宜均应向合格的人员咨询。如果设备有任何损坏，均需进行维修，例如电源线或插头受损、液体溅入或物体落入设备内、设备受雨淋或受潮、不能正常工作或跌落。

警告/小心

- 请勿长时间在高音量下使用耳机。
 - 为了避免听力受损，请以舒适、适度的音量使用耳机。
 - 先将设备音量调低，然后再戴上耳机，之后再逐渐调高音量，直到达到舒适的听觉效果。
- 切勿在驾车时将耳机用于接听电话或其他用途。
- 切勿在无法听到周围的声音即可能对自己或他人造成危险时使用耳机的“消噪”模式，例如，在道路、施工现场或铁路附近骑自行车或步行等，并遵守与耳机使用相关的适用法律。
 - 关闭耳机，或将“降噪”功能关闭并调节音量，以保证能够听到周围的声音，包括报警和警报信号。
 - 了解使用耳机时作为提醒或警告的声音如何相应变化，即使在适应模式下。
- 如果耳机发出不正常的杂音，请勿使用。在此情况下，请关闭耳机，然后联系 Bose 客户服务处。
- 如果您感觉到发热或听不到声音，请立即取下耳机。
- 切勿使用手机适配器来连接耳机和飞机座椅插孔，因为由此产生的高温可能会导致人身伤害或财产损失。
- 请勿使用本耳机作为航空通讯耳机。



包含小部件，可能会导致窒息。不适合 3 岁以下的儿童使用。



本产品含有磁性材料。关于是否会影响可植入医疗设备的情况，请咨询医生。

- 为了减少火灾或电击危险，请勿使本产品暴露在雨中，被液体淋溅、喷洒，或暴露在潮湿环境中，也不得将装有液体的物体（如花瓶等）置于本产品上或本产品附近。
- 请将本产品放置到远离火源和热源的地方。请勿将明火火源（如点燃的蜡烛）置于本产品上或靠近本产品。
- 仅将本产品搭配经过相关部门批准且符合本地监管要求（如 UL、CSA、VDE、CCC）的 LPS 电源使用。
- 未经授权切勿改装本产品。
- 如果电池漏液，请避免让液体与皮肤或眼睛接触。如果接触到了液体，请咨询医生。
- 请勿使含有电池的产品过热（例如，请避免阳光直射并远离火源等）。
- 请勿在充电时佩戴。

注意: 本设备已经过测试，符合 FCC 规则第 15 部分有关 B 类数字设备的各项限制。这些限制性规定旨在防范安装在住宅中的设备产生有害干扰。本设备产生、使用并可能散发无线射频能量，如果不按照指示安装和使用，则可能会对无线电通讯造成有害干扰。然而，按照指示安装也不能保证某些安装不会发生干扰。如果本设备确实对无线电或电视接收造成有害干扰（可通过关闭和打开本设备来确定），用户可尝试采取以下一种或多种措施来纠正干扰：

- 重新调整接收产品或天线的方向或位置。
- 增大本设备和接收器的间距。
- 将本设备和接收器的电源线插入不同线路上的插座中。
- 请咨询经销商或有经验的无线电/电视技术人员以获得帮助。

未经 Bose Corporation 明确批准，擅自更改或改装本设备会使用户操作本设备的权利失效。

本设备符合 FCC 规则第 15 部分规定和加拿大 ISED 免许可证 RSS 标准。本设备工作时应满足下列两项要求：(1) 本设备不会造成有害干扰；(2) 本设备必须承受任何接收到的干扰，包括可能造成设备异常工作的干扰。

本设备符合为公众阐明的 FCC 和加拿大 ISED 辐射限制。此发射器不能与其他天线或发射器位于同一地点或与这些设备一起使用。

符合 IMDA 要求。

FCC ID: A94437310

IC: 3232A-437310

CAN ICES-3(B)/NMB-3(B)

欧洲:

工作频段 2400 至 2483.5 MHz。

最大传输功率低于 20 dBm EIRP。

最大传输功率低于规定限值，因此无需 SAR 测试或根据适用法规豁免。



此标志表示本产品不得作为生活垃圾丢弃，必须送至相关回收部门循环利用。适当的处理和回收有助于保护自然资源、人类健康以及自然环境。想了解更多有关本产品的处理和回收信息，请与当地民政部门、废弃物处理服务机构或出售本产品的商店联系。

低功率射頻器材技術規範

取得審驗證明之低功率射頻器材，非經核准，公司、商號或使用者均不得擅自變更頻率、加大功率或變更原設計之特性及功能。低功率射頻器材之使用不得影響飛航安全及干擾合法通信；經發現有干擾現象時，應立即停用，並改善至無干擾時方得繼續使用。前述合法通信，指依電信管理法規定作業之無線電通信。低功率射頻器材須忍受合法通信或工業、科學及醫療用電波輻射性電機設備之干擾。

请勿尝试拆除产品内的可充电锂电池。请联系当地的 Bose 经销商或其他有资格的专业人士进行拆除。

移除本产品中的可充电锂离子电池必须由专业人士操作。请联系本地 Bose 零售商或查看 products.bose.com/static/compliance/index.html 了解更多信息。



请适当处理废旧电池，遵守本地规章。切勿将其焚化。



有毒或有害物质或元素的名称及成分						
零件名称	有毒或有害物质和元素					
	铅 (Pb)	汞 (Hg)	镉 (Cd)	六价铬 (CR(VI))	多溴化联苯 (PBB)	多溴二苯醚 (PBDE)
印刷电路板	X	0	0	0	0	0
金属零件	X	0	0	0	0	0
塑料零件	0	0	0	0	0	0
扬声器	X	0	0	0	0	0
线缆	X	0	0	0	0	0
此表格符合 SJ/T 11364 条款。 0：表示此零件中所有同类物质包含的有毒或有害物质低于 GB/T 26572 中的限定要求。 X：表示此零件使用的同类物质中至少有一种包含的有毒或有害物质高于 GB/T 26572 中的限定要求。						

生产日期： 序列号中第八位数字表示生产年份；“2”表示 2012 年或 2022 年。

中国进口商： 博士视听系统（上海）有限公司，上海市闵行区古岱路 2337 号 D 座 6 层，201100

欧洲进口商： Bose Products B.V., Gorslaan 60, 1441 RG Purmerend, The Netherlands

墨西哥进口商： Bose de México S. de R.L. de C.V., Avenida Prado Sur #150, Piso 2, Interior 222 y 223, Colonia Lomas de Chapultepec V Sección, Miguel Hidalgo, Ciudad de México, C.P.11000
电话：+5255 (5202) 3545

台湾进口商： Bose 台湾分公司 (H.K.), 台湾台北市民生东路 3 段 10 号 9F 10480
电话：+886-2-2514 7676

英国进口商： Bose Limited, Bose House, Quayside Chatham Maritime, Chatham, Kent, ME4 4QZ, United Kingdom

输入额定值： 5 V --- 0.5 A

充电温度范围： 0°C - 45°C

放电温度范围： -20°C - 60°C

型号 437310。CMIIT ID 位于耳罩内基布的下方。

请填写以下内容，留作记录

序列号和型号位于耳罩基布下方内侧。

序列号： _____

型号： _____

请将收据与用户指南存放在一处。现在是您注册 Bose 产品的好机会。

您可以访问 worldwide.Bose.com/ProductRegistration 轻松完成此操作。

安全性信息



连接 Bose Music 应用时，此产品能够自动接收来自 Bose 的安全性更新。要通过移动应用接收安全性更新，您必须在 Bose Music 应用中完成产品设置流程。**如果您没有完成设置流程，您需要通过以下网址自行安装 Bose 届时提供的安全性更新：btu.bose.com**

Apple、Apple 徽标、iPad、iPhone 以及 iPod 是 Apple Inc. 在美国和其他国家注册的商标。App Store 是 Apple Inc. 的服务标识。商标“iPhone”已获得 Aiphone K.K. 在日本的使用许可。

使用“Apple 专用”标记表示此附件的设计专门用来连接标记中认定的 Apple 产品，并且通过了开发商的认证，符合 Apple 的性能标准。Apple 对此设备的工作或其与安全 and 规章标准的符合性概不负责。

Bluetooth® 文字标记和徽标是由 Bluetooth SIG, Inc. 所拥有的注册商标，Bose 公司根据许可规定使用上述标记。

Google Play 是 Google LLC 的商标。

USB Type-C® 和 USB-C® 是 USB 应用者论坛的注册商标。

Bose、Bose Home Speaker、Bose Music、Bose Music 标志、Bose Smart Soundbar、Bose Smart Speaker、Bose Soundbar、QuietComfort 和 SimpleSync 是 Bose Corporation 的商标。

Bose 公司总部：1-877-230-5639

©2022 Bose Corporation。未经事先书面许可，不得复制、修改、发行或以其他方式使用本资料的任何部分。

The following license disclosures apply to certain third-party software packages used as components in the product.

Package: FreeRTOS

Copyright © Amazon Web Services, Inc. or its affiliates. All rights reserved.

The FreeRTOS package is subject to the license terms reprinted below:

MIT License

Permission is hereby granted, free of charge, to any person obtaining a copy of this software and associated documentation files (the “Software”), to deal in the Software without restriction, including without limitation the rights to use, copy, modify, merge, publish, distribute, sublicense, and/or sell copies of the Software, and to permit persons to whom the Software is furnished to do so, subject to the following conditions:

The above copyright notice and this permission notice shall be included in all copies or substantial portions of the Software.

THE SOFTWARE IS PROVIDED “AS IS”, WITHOUT WARRANTY OF ANY KIND, EXPRESS OR IMPLIED, INCLUDING BUT NOT LIMITED TO THE WARRANTIES OF MERCHANTABILITY, FITNESS FOR A PARTICULAR PURPOSE AND NONINFRINGEMENT. IN NO EVENT SHALL THE AUTHORS OR COPYRIGHT HOLDERS BE LIABLE FOR ANY CLAIM, DAMAGES OR OTHER LIABILITY, WHETHER IN AN ACTION OF CONTRACT, TORT OR OTHERWISE, ARISING FROM, OUT OF OR IN CONNECTION WITH THE SOFTWARE OR THE USE OR OTHER DEALINGS IN THE SOFTWARE.

Package: Nanopb

Copyright © 2011 Petteri Aimonen <jpa at nanopb.mail.kapsi.fi>.

The Nanopb package is subject to the license terms reprinted below:

Zlib License

© 2011 Petteri Aimonen <jpa at nanopb.mail.kapsi.fi>

This software is provided ‘as-is’, without any express or implied warranty. In no event will the authors be held liable for any damages arising from the use of this software.

Permission is granted to anyone to use this software for any purpose, including commercial applications, and to alter it and redistribute it freely, subject to the following restrictions:

1. The origin of this software must not be misrepresented; you must not claim that you wrote the original software. If you use this software in a product, an acknowledgment in the product documentation would be appreciated but is not required.
2. Altered source versions must be plainly marked as such, and must not be misrepresented as being the original software.
3. This notice may not be removed or altered from any source distribution.

Package: Mbed TLS 2.16.1

© ARM Limited. All rights reserved.

The Mbed TLS package is subject to the license terms reprinted below:

Apache License

Version 2.0, January 2004

<http://www.apache.org/licenses/>

TERMS AND CONDITIONS FOR USE, REPRODUCTION, AND DISTRIBUTION

1. Definitions.
“License” shall mean the terms and conditions for use, reproduction, and distribution as defined by Sections 1 through 9 of this document.

“Licensor” shall mean the copyright owner or entity authorized by the copyright owner that is granting the License.

“Legal Entity” shall mean the union of the acting entity and all other entities that control, are controlled by, or are under common control with that entity. For the purposes of this definition, “control” means (i) the power, direct or indirect, to cause the direction or management of such entity, whether by contract or otherwise, or (ii) ownership of fifty percent (50%) or more of the outstanding shares, or (iii) beneficial ownership of such entity.

“You” (or “Your”) shall mean an individual or Legal Entity exercising permissions granted by this License.

“Source” form shall mean the preferred form for making modifications, including but not limited to software source code, documentation source, and configuration files.

“Object” form shall mean any form resulting from mechanical transformation or translation of a Source form, including but not limited to compiled object code, generated documentation, and conversions to other media types.

“Work” shall mean the work of authorship, whether in Source or Object form, made available under the License, as indicated by a copyright notice that is included in or attached to the work (an example is provided in the Appendix below).

“Derivative Works” shall mean any work, whether in Source or Object form, that is based on (or derived from) the Work and for which the editorial revisions, annotations, elaborations, or other modifications represent, as a whole, an original work of authorship. For the purposes of this License, Derivative Works shall not include works that remain separable from, or merely link (or bind by name) to the interfaces of, the Work and Derivative Works thereof.

“Contribution” shall mean any work of authorship, including the original version of the Work and any modifications or additions to that Work or Derivative Works thereof, that is intentionally submitted to Licensor for inclusion in the Work by the copyright owner or by an individual or Legal Entity authorized to submit on behalf of the copyright owner. For the purposes of this definition, “submitted” means any form of electronic, verbal, or written communication sent to the Licensor or its representatives, including but not limited to communication on electronic mailing lists, source code control systems, and issue tracking systems that are managed by, or on behalf of, the Licensor for the purpose of discussing and improving the Work, but excluding communication that is conspicuously marked or otherwise designated in writing by the copyright owner as “Not a Contribution.”

“Contributor” shall mean Licensor and any individual or Legal Entity on behalf of whom a Contribution has been received by Licensor and subsequently incorporated within the Work.

2. Grant of Copyright License. Subject to the terms and conditions of this License, each Contributor hereby grants to You a perpetual, worldwide, non-exclusive, no-charge, royalty-free, irrevocable copyright license to reproduce, prepare Derivative Works of, publicly display, publicly perform, sublicense, and distribute the Work and such Derivative Works in Source or Object form.
3. Grant of Patent License. Subject to the terms and conditions of this License, each Contributor hereby grants to You a perpetual, worldwide, non-exclusive, no-charge, royalty-free, irrevocable (except as stated in this section) patent license to make, have made, use, offer to sell, sell, import, and otherwise transfer the Work, where such license applies only to those patent claims licensable by such Contributor that are necessarily infringed by their Contribution(s) alone or by combination of their Contribution(s) with the Work to which such Contribution(s) was submitted. If You institute patent litigation against any entity (including a cross-claim or counterclaim in a lawsuit) alleging that the Work or a Contribution incorporated within the Work constitutes direct or contributory patent infringement, then any patent licenses granted to You under this License for that Work shall terminate as of the date such litigation is filed.
4. Redistribution. You may reproduce and distribute copies of the Work or Derivative Works thereof in any medium, with or without modifications, and in Source or Object form, provided that You meet the following conditions:
 - a. You must give any other recipients of the Work or Derivative Works a copy of this License; and
 - b. You must cause any modified files to carry prominent notices stating that You changed the files; and
 - c. You must retain, in the Source form of any Derivative Works that You distribute, all copyright, patent, trademark, and attribution notices from the Source form of the Work, excluding those notices that do not pertain to any part of the Derivative Works; and

d. If the Work includes a “NOTICE” text file as part of its distribution, then any Derivative Works that You distribute must include a readable copy of the attribution notices contained within such NOTICE file, excluding those notices that do not pertain to any part of the Derivative Works, in at least one of the following places: within a NOTICE text file distributed as part of the Derivative Works; within the Source form or documentation, if provided along with the Derivative Works; or, within a display generated by the Derivative Works, if and wherever such third-party notices normally appear. The contents of the NOTICE file are for informational purposes only and do not modify the License. You may add Your own attribution notices within Derivative Works that You distribute, alongside or as an addendum to the NOTICE text from the Work, provided that such additional attribution notices cannot be construed as modifying the License.

You may add Your own copyright statement to Your modifications and may provide additional or different license terms and conditions for use, reproduction, or distribution of Your modifications, or for any such Derivative Works as a whole, provided Your use, reproduction, and distribution of the Work otherwise complies with the conditions stated in this License.

5. Submission of Contributions. Unless You explicitly state otherwise, any Contribution intentionally submitted for inclusion in the Work by You to the Licensor shall be under the terms and conditions of this License, without any additional terms or conditions. Notwithstanding the above, nothing herein shall supersede or modify the terms of any separate license agreement you may have executed with Licensor regarding such Contributions.
6. Trademarks. This License does not grant permission to use the trade names, trademarks, service marks, or product names of the Licensor, except as required for reasonable and customary use in describing the origin of the Work and reproducing the content of the NOTICE file.
7. Disclaimer of Warranty. Unless required by applicable law or agreed to in writing, Licensor provides the Work (and each Contributor provides its Contributions) on an “AS IS” BASIS, WITHOUT WARRANTIES OR CONDITIONS OF ANY KIND, either express or implied, including, without limitation, any warranties or conditions of TITLE, NON-INFRINGEMENT, MERCHANTABILITY, or FITNESS FOR A PARTICULAR PURPOSE. You are solely responsible for determining the appropriateness of using or redistributing the Work and assume any risks associated with Your exercise of permissions under this License.
8. Limitation of Liability. In no event and under no legal theory, whether in tort (including negligence), contract, or otherwise, unless required by applicable law (such as deliberate and grossly negligent acts) or agreed to in writing, shall any Contributor be liable to You for damages, including any direct, indirect, special, incidental, or consequential damages of any character arising as a result of this License or out of the use or inability to use the Work (including but not limited to damages for loss of goodwill, work stoppage, computer failure or malfunction, or any and all other commercial damages or losses), even if such Contributor has been advised of the possibility of such damages.
9. Accepting Warranty or Additional Liability. While redistributing the Work or Derivative Works thereof, You may choose to offer, and charge a fee for, acceptance of support, warranty, indemnity, or other liability obligations and/or rights consistent with this License. However, in accepting such obligations, You may act only on Your own behalf and on Your sole responsibility, not on behalf of any other Contributor, and only if You agree to indemnify, defend, and hold each Contributor harmless for any liability incurred by, or claims asserted against, such Contributor by reason of your accepting any such warranty or additional liability.

END OF TERMS AND CONDITIONS

©2022 Bose Corporation

Licensed under the Apache License, Version 2.0 (the “License”); you may not use this file except in compliance with the License.

You may obtain a copy of the License at: <http://www.apache.org/licenses/LICENSE-2.0>

Unless required by applicable law or agreed to in writing, software distributed under the License is distributed on an “AS IS” BASIS, WITHOUT WARRANTIES OR CONDITIONS OF ANY KIND, either express or implied.

See the License for the specific language governing permissions and limitations under the License.

装箱单

内件	13
----------	----

BOSE MUSIC 应用

下载 Bose Music 应用	14
将耳机添加至已有帐户	14

耳机控件

打开电源	16
待机计时器	16
关闭电源	17
耳机功能	18
媒体播放和音量	18
通话	19
操作按钮	20

消噪

消噪模式	21
更改消噪模式	21

语音控件

使用语音控件	22
--------------	----

BLUETOOTH® 连接

使用移动设备上的 <i>Bluetooth</i> 菜单连接	23
断开移动设备	25
重新连接移动设备	25
连接另一台移动设备	25
识别已连接的移动设备	25
在两台已连接的移动设备之间切换	25
重新连接之前曾连接过的设备	26
清空耳机的设备列表	26

有线连接

连接音频连接线.....	27
--------------	----

电池

为耳机充电.....	28
充电时间.....	28
收听电池电量提示.....	28

耳机状态

<i>Bluetooth</i> 状态.....	29
电池状态.....	29
充电状态.....	30
更新和错误状态.....	30

连接 BOSE 产品

连接 Bose Smart Speaker 或 Bose Smart Soundbar.....	31
优势.....	31
兼容产品.....	31
使用 Bose Music 应用连接.....	31
重新连接 Bose Smart Speaker 或 Bose Smart Soundbar.....	32

维护与保养

存放耳机.....	33
清洁耳机.....	34
更换零件和配件.....	34
有限质保.....	34
序列号位置.....	35

故障排除

首先尝试这些解决方案.....	36
其他解决方案.....	36
将耳机恢复为出厂设置。.....	39

内件

请确认包装箱中内含以下部件：



Bose QuietComfort 45 耳机

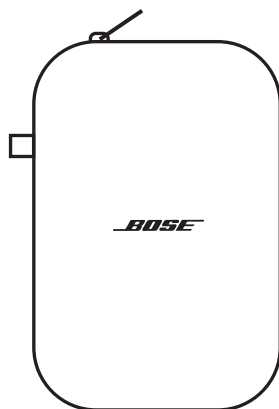

软便携包



USB Type-C® 线

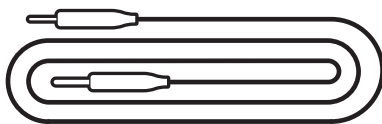

3.5 mm 至 2.5 mm 音频连接线

注意：如果产品部分损坏，请勿使用。请联系 Bose 授权经销商或 Bose 客户服务处。

请访问：support.Bose.com/QCSE

您可在任何移动设备（例如智能手机或平板电脑）上通过 Bose Music 应用设置和控制耳机。

您可以使用此应用管理 *Bluetooth* 连接、管理耳机设置、选择自己的语音提示语言和通过更新获得新功能。

注意：如果您已为其他 Bose 产品创建了 Bose Music 帐户，请将耳机添加到您的现有帐户（请见第 14 页的最下方）。

下载 BOSE MUSIC 应用

1. 在移动设备上，下载 Bose Music 应用。

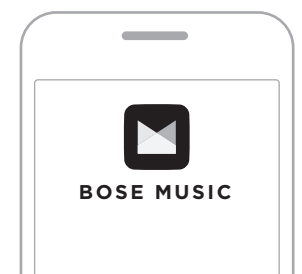

2. 请按照应用说明执行操作。

将耳机添加至已有帐户

要添加 Bose QuietComfort 45 耳机，请打开 Bose Music 应用并添加耳机。



打开电源

在右侧耳罩上，将“电源/Bluetooth”开关滑动至右侧。

语音提示播放电池电量，状态指示灯根据当前的充电电量（参见第 29 页）亮起。



待机计时器

耳机未使用时待机计时器可节省电池电量。

请使用 Bose Music 应用设置并自定义待机计时器。

关闭电源

将电源/*Bluetooth* 开关滑动到左侧。

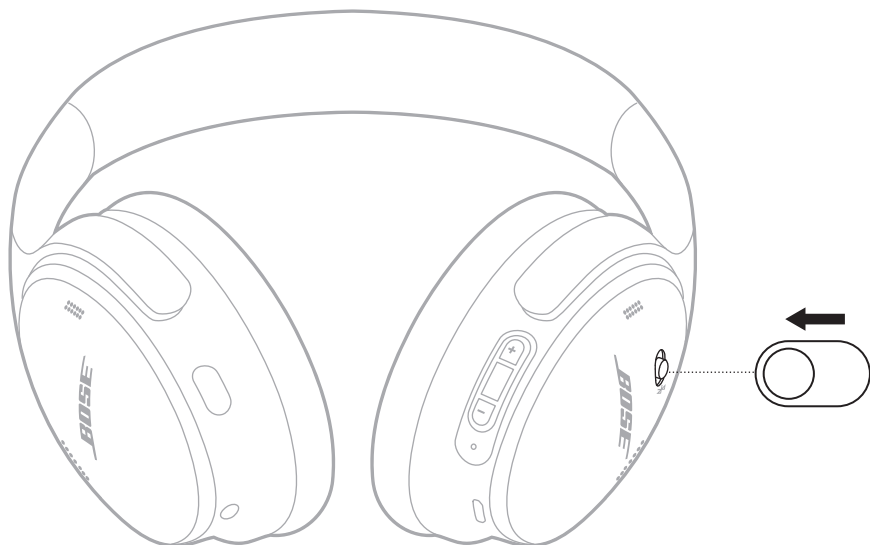

注意：关闭耳机电源后，将禁用消噪。

耳机功能

耳机控件位于右侧耳罩的背面。

媒体播放和音量

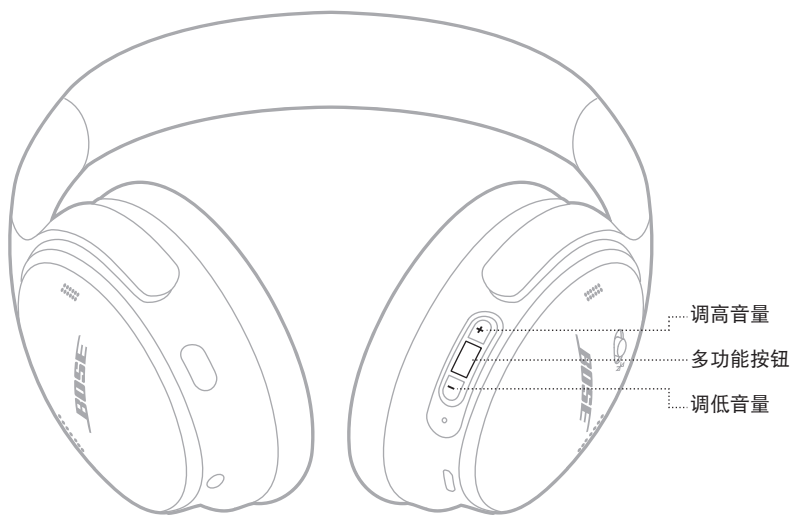

功能	操作方法
播放/暂停	按下多功能按钮。
快进	按两下多功能按钮。
快退	按三下多功能按钮。
调高音量	按下+。
调低音量	按下-。

注意：

- 要快速提高音量，按住+。
- 要快速降低音量，按住-。

通话

多功能按钮位于右侧耳罩的背面。麦克风位于右耳罩的正面附近。

操作按钮位于左侧耳罩的背面。

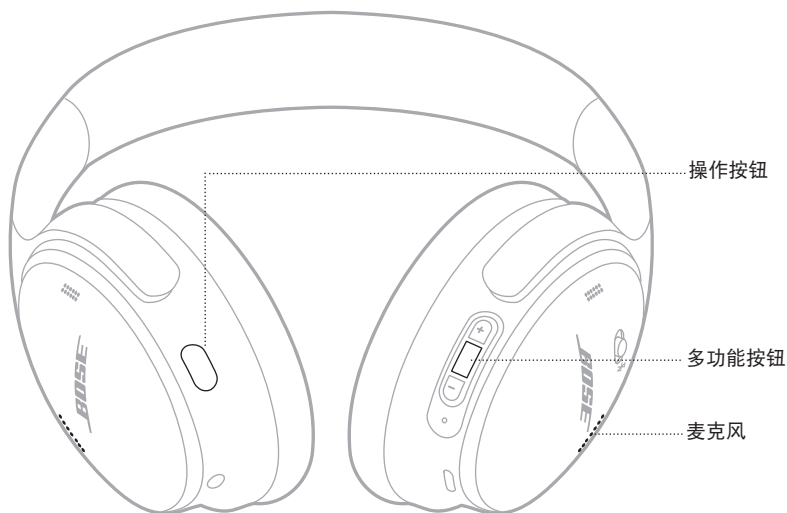

功能	操作方法
接听/结束通话	按下多功能按钮。
拒绝接听来电	按住多功能按钮 1 秒。
保持当前呼叫并接听第二个来电	在通话时，当第二个来电铃声响起时，按多功能按钮。
拒绝第二个来电并保留在当前通话中	在通话时，当第二个来电铃声响起时，按住多功能按钮 1 秒。
在两个呼叫之间切换	同时接通两路通话时，按两下多功能按钮。
创建一个会议电话	同时接通两路通话时，按住多功能按钮 3 秒。
静音/取消静音	在通话时按操作按钮。

操作按钮

您可以使用操作按钮快速轻松地切换消噪模式。

操作按钮位于左侧耳罩的背面。

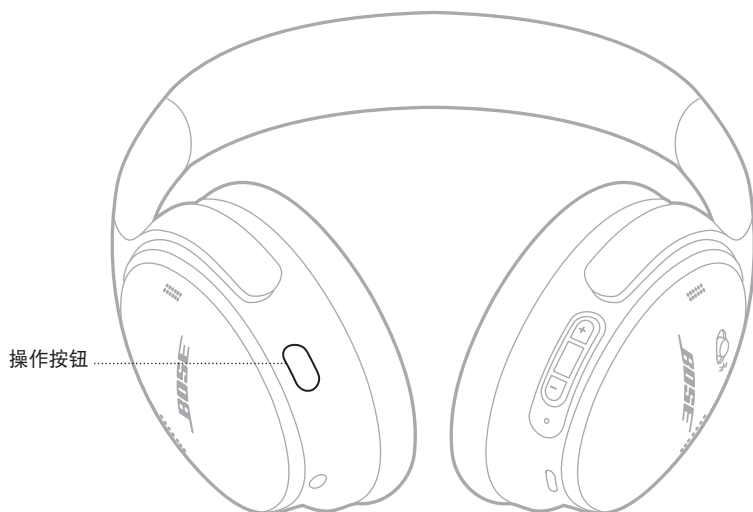

要在安静模式和适应模式之间切换，请按操作按钮。

有关不同消噪模式的信息，请参见第 21 页。

消噪可以减少不需要的噪音，提供更清晰和更逼真的音频性能。可以选择两种消噪模式：安静和适应。

安静模式可以使用最高的消噪级别来防止干扰。

适应模式以完全通透的形式，让您在享受音频的同时还能听到周遭的声音。

可以根据收听偏好和环境选择消噪模式。

消噪模式

模式	说明
安静	顶级消噪，可提供 Bose 优化音频。
适应	在享受音频的同时听到周围环境的声音。

注意：打开电源后，耳机会默认启用上次使用的模式。

更改消噪模式

请按操作按钮更改消噪模式。

语音提示功能将播报选择的消噪模式。

提示：您也可使用 Bose Music 应用更改消噪模式。

使用语音控件

您可以通过耳机使用移动设备上的语音控制。要使用语音控制，按住多功能按钮 1 秒。多功能按钮位于右侧耳罩的背面。

注意：通话时无法访问语音控件。

使用移动设备上的 **BLUETOOTH** 菜单连接

耳机的设备列表中最多存储八台设备，并且耳机一次可以主动连接两台设备。一次只能播放一台设备的音频。

注意：为了获得最佳体验，使用 Bose Music 应用设置并连接移动设备（请参见第 14 页）。

1. 将电源/*Bluetooth* 按钮滑至右侧  并按住 3 秒。

您将听到“Ready to connect”（准备连接），且状态指示灯闪烁蓝色光。



2. 在您的设备上启用 *Bluetooth* 功能。

注意：*Bluetooth* 功能通常在“设置”菜单中。

3. 从设备列表中选择耳机。

提示：在 Bose Music 应用中查找您为耳机输入的名称。如果没有为耳机命名，将显示默认名称。



连接后，您会听到“Connected to <device name>”（已连接 <设备名称>），状态指示灯常亮蓝色光 10 秒。

断开移动设备

使用 Bose Music 应用断开移动设备。

提示：您也可使用 *Bluetooth* 设置断开设备。禁用 *Bluetooth* 功能后，所有其他设备连接都将断开。

重新连接移动设备

打开电源时，耳机将尝试与两台最近连接的设备重新建立连接。

注意：

- 这些设备必须在连接范围内 (9 m) 并已通电。
- 请确保您的移动设备已启用 *Bluetooth* 功能。

连接另一台移动设备

要连接另一台设备，请下载 Bose Music 应用（请参阅第 14 页）或使用移动设备上的 *Bluetooth* 菜单（请参阅第 23 页）。

注意：您一次只能播放一台设备的音频。

识别已连接的移动设备

将电源/*Bluetooth* 开关滑到右侧 ✧ 并松开即可听到当前哪台设备已连接。

在两台已连接的移动设备之间切换

1. 暂停第一个移动设备的音频。
2. 播放第二个移动设备的音频。

注意：无论哪台设备播放音频，您的耳机都可以接收两台设备上的电话来电。

重新连接之前曾连接过的设备

1. 将电源/*Bluetooth* 开关滑到右侧 ✳ 并松开即可听到哪台设备已连接。
2. 在 2 秒内再次将电源/*Bluetooth* 滑到右侧 ✳ 并松开可连接耳机设备列表中的下一设备。
3. 重复该操作，直到您听到正确的设备名称。
您会听到表示设备已连接的提示音。
4. 播放连接的移动设备的音频。

注意：如果有两个设备已经连接到耳机，新连接的设备将取代之前连接的第二个设备。

清空耳机的设备列表

1. 将电源/*Bluetooth* 开关滑至右侧 ✳ 并按住 15 秒，直到听到 “*Bluetooth device list cleared. Ready to connect.*” (*Bluetooth* 设备列表已清空。已准备好连接。)
2. 从移动设备的 *Bluetooth* 列表中删除您的耳机。
所有设备被删除，耳机可开始连接。

连接音频连接线

如果电池电量已耗尽，使用 2.5 mm 到 3.5 mm 连接线连接非无线设备或继续使用耳机。

1. 将连接线连接至左侧耳罩的 2.5 mm 端口。



2. 将连接线的另一端连接至设备上的 3.5 mm 端口。

注意：当已连接音频线时，可以使用耳机来打开或关闭电源。

为耳机充电

1. 请将 USB 线缆的较小端连接到右耳罩上的 USB-C 端口。
2. 将另一端连接到 USB 壁式充电器。



注意：

- 当耳机开始充电时，状态指示灯闪烁白色光 10 秒钟。充满电后，状态灯呈常亮白色光亮起。
- 充电时耳机不工作。

充电时间

最长需要 2.5 小时即可将耳机充满电。

收听电池电量提示

每次打开耳机电源时，语音提示都会播报电池电量。如果耳机电池电量不足，您会听到“Battery low, please charge now.”（电池电量低，请立即充电。）。

注意：若要目测检查电池，查看位于右侧耳罩的状态指示灯。详细信息，请参见第 29 页上的“电池状态”。

状态指示灯位于右侧耳罩上。



BLUETOOTH 状态

显示 Bluetooth 连接状态。

指示灯活动	系统状态
闪烁蓝色光	已准备好连接
常亮蓝色光 (10 秒)	已连接

电池状态

显示电池电量。

指示灯活动	系统状态
常亮白色光	中等电量到满电量
琥珀色光常亮	低电量

提示：您也可使用 Bose Music 应用检查电池电量。

充电状态

显示充电状态。

指示灯活动	系统状态
闪烁白色光 2 次	充电开始
琥珀色光常亮	正在充电
常亮白色光	充满电

更新和错误状态

显示更新和错误状态。

指示灯活动	系统状态
快速闪烁白色光 (10 秒)	更新软件 (通过 USB)
缓慢闪烁白色光 (30 至 60 秒)	更新软件 (无线)
闪烁琥珀色光和白色光	错误 - 联系 Bose 客户服务处

连接 BOSE SMART SPEAKER 或 BOSE SMART SOUNDBAR

采用 SimpleSync™ 技术，您可以将耳机连接到 Bose Smart Soundbar 或 Bose Smart Speaker，享受个性化聆听体验。

优势

- 使用每个产品上的独立音量控制，在您降低 Bose Smart Soundbar 的音量或使其静音的同时，耳机聆听的音量可以随您喜爱，要多大声就多大声。
- 将您的耳机连接到 Bose Smart Speaker，即可在另一个房间清晰地聆听音乐。

注意：SimpleSync™ 技术的 *Bluetooth* 连接范围为 9 m。墙壁和建筑材料可能会影响信号接收。

兼容产品

您可以将耳机连接到任何 Bose Smart Speaker 或 Bose Smart Soundbar。

受欢迎的兼容产品包括：

- Bose Smart Soundbar 700/Bose Soundbar 700
- Bose Soundbar 500
- Bose Smart Speaker 500/Bose Home Speaker 500
- Bose Home Speaker 300
- Bose Portable Smart Speaker/Bose Portable Home Speaker

将定期添加新产品。如果需要完整列表和更多信息，请访问：
worldwide.bose.com/Support/Groups

使用 Bose Music 应用连接

1. 将耳机上的电源/*Bluetooth* 开关滑至右侧  并按住 3 秒。

您会听到“Ready to connect another device”（准备连接另一台设备），然后状态指示灯闪烁蓝色光。

2. 使用 Bose Music 应用将耳机连接到兼容的 Bose 产品。有关更多信息，请访问：
worldwide.bose.com/Support/Groups

注意：

- 确保耳机在条形音箱或扬声器的 9 米连接范围内。
- 您一次只能将耳机连接到一个产品。

重新连接 BOSE SMART SPEAKER 或 BOSE SMART SOUNDBAR

打开耳机电源（请参见第 16 页上的“打开电源”）。

耳机尝试连接到最近连接的两台 *Bluetooth* 设备，包括条形音箱或扬声器。

注意：

- 条形音箱或扬声器必须在范围（9 米）内并已通电。
- 如果耳机未连接，请参见第 38 页上的“耳机未重新连接之前连接的 Bose Smart Soundbar 或 Bose Smart Speaker”。

存放耳机

将耳罩旋转以便于保存。将耳机平放入盒中。

1. 向内旋转两个耳罩，将其放平。



2. 将左耳罩向上向头带方向折。

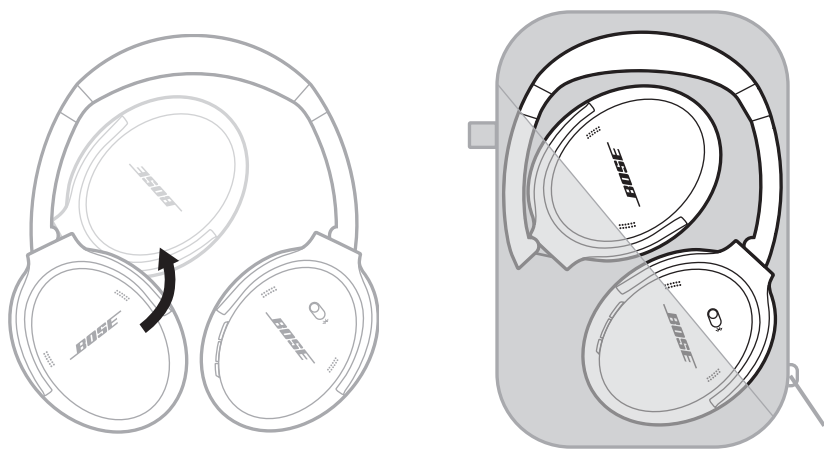

注意：

- 不使用时，请确保关闭耳机。
- 长期存放耳机之前，请确保电池电量充满。

清洁耳机

使用柔软的干布擦拭耳机表面。

请勿让水汽进入耳罩内部。

更换零件和配件

可通过 Bose 客户服务处订购更换零件或配件。

请访问：support.bose.com/QCSE

有限质保

您的耳机享受有限质保。有关有限质保的详细信息，请访问我们的网站：worldwide.bose.com/Warranty。

要注册您的产品，请访问 worldwide.bose.com/ProductRegistration 以获取说明。未进行注册并不影响您的有限质保权利。

序列号位置

序列号位于右侧耳罩基布下方内侧。基布是盖住和保护耳机内组件的内侧隔布。

要查看序列号，抓住基布上缘并轻轻撕开。

小心：注意不要按下或取下耳罩内的任何其它组件，否则会损坏耳机。

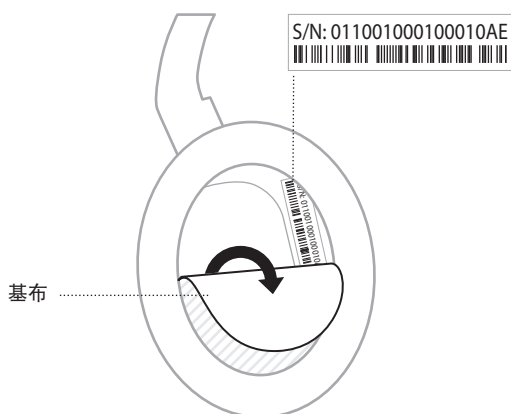

首先尝试这些解决方案

如果耳机出现问题：

- 检查状态指示灯的状态（请参见第 29 页）。
- 为电池充电（请参见第 28 页）。
- 调高耳机、移动设备和音乐应用的音量。
- 下载 Bose Music 应用并运行可用的软件更新（请参见第 14 页）。
- 尝试连接其他移动设备（请参见第 25 页）。

若无法解决问题，请参见下表了解常见问题的症状和解决方案。若仍然无法解决问题，请联系 Bose 客户服务处。

请访问：worldwide.Bose.com/contact

其他解决方案

症状	解决方案
耳机电源无法打开	给电池充电。
耳机未与移动设备连接	<p>断开备用音频连接线。</p> <p>断开 USB 充电线缆的连接。</p> <p>在您的移动设备上：</p> <p>禁用 <i>Bluetooth</i> 功能并重新启用。</p> <p>从设备的 <i>Bluetooth</i> 列表中删除您的 Bose QuietComfort 45 耳机，包括任何标有 LE（低能量）的重复列表。再次连接。</p> <p>将移动设备靠近耳机，远离其他干扰或障碍物。</p> <p>请访问 support.Bose.com/QCSE 查看说明视频。</p> <p>清空已连接设备列表（请参见第 26 页）并再次连接。</p>
电池不充电	<p>牢固插入 USB 充电线末端。</p> <p>试试另一个充电源。</p> <p>如果您的耳机曾被暴露在高温或低温环境中，等待耳机恢复室温，然后重试充电。</p>

症状	解决方案
没有声音	<p>打开耳机电源，然后为电池充电。</p> <p>检查状态指示灯的状态（请参见第 29 页）。</p> <p>将电源/<i>Bluetooth</i> 开关滑到右侧并释放即可听到已连接设备。确保您使用的是正确的设备。</p> <p>将移动设备靠近耳机，远离其他干扰或障碍物。</p> <p>请使用其他音乐源。</p> <p>如果连接了两台移动设备，先暂停另一台设备。</p> <p>如果连接了两台移动设备，将设备移到耳机的连接范围内 (9 m)。</p> <p>尝试移动设备上本地存储的音乐或视频文件。</p>
音质差	<p>请使用其他音乐源。</p> <p>连接另一台移动设备（请参见第 25 页）。</p> <p>断开第二个设备的连接。</p> <p>将移动设备靠近耳机，远离其他干扰或障碍物。</p> <p>尝试移动设备上本地存储的音乐或视频文件。</p>
从使用备用音频连接线连接的设备中听不到声音	<p>固定备用音频连接线末端。</p> <p>调高耳机、移动设备和音乐源的音量。</p> <p>连接另一台设备（请参见第 25 页）。</p>
通过音频连接线连接的设备的音质差	<p>固定备用音频连接线末端。</p> <p>连接另一台设备（请参见第 25 页）。</p>
操作按钮无法更改消噪模式	<p>请确保耳机的电源已打开。</p> <p>使用 Bose Music 应用更改消噪模式。</p>

症状	解决方案
耳机未连接到 Bose Smart Soundbar 或 Bose Smart Speaker	滑动并按住“电源/ <i>Bluetooth</i> ”按钮，直到听到“Ready to connect another device”（准备连接另一台设备），并且 <i>Bluetooth</i> 指示灯闪烁蓝色光。 确保耳机在条形音箱或扬声器的 9 米连接范围内。
耳机未重新连接之前连接的 Bose Smart Soundbar 或 Bose Smart Speaker	重新连接先前已连接的设备（请参见第 26 页）。
连接到 Bose Smart Soundbar 或 Bose Smart Speaker 时音频存在延迟	下载 Bose Music 应用并运行可用的软件更新。

恢复出厂设置可以清除所有设置，使耳机恢复到开箱时的原始状态。之后，耳机可以像首次设置那样进行配置。

只有当您的耳机出现问题，或者 Bose 客户服务人员指示您这样做时，才建议恢复出厂设置。

将耳机恢复为出厂设置。

1. 从设备的 *Bluetooth* 列表中移除耳机。
2. 使用 Bose Music 应用将耳机从 Bose 帐户中移除。

注意：关于如何使用 Bose Music 应用从您的 Bose 帐户中移除耳机的更多信息，请访问 support.Bose.com/QCSE

3. 将电源/*Bluetooth* 按钮滑至右侧 * 并按住。同时按住操作按钮 30 秒。
状态指示灯会闪烁白色光。30 秒后状态灯闪烁黄色，表示正在恢复出厂设置 (2 至 3 秒)。
4. 恢复完成后，状态灯缓慢闪烁蓝色光。耳机现在处于开箱后的原始状态。

請閱讀並保管好所有安全、安全性和使用指示。

 Bose Corporation 在此聲明本產品遵守 2014/53/EU 指令和其他所有適用歐盟指令要求中的基本要求和相關規定。您可以從以下位置找到完整的符合聲明：www.Bose.com/compliance

 本產品符合所有適用的 2016 電磁相容性法規和所有其他適用的英國法規。您可以從以下位置找到完整的符合聲明：www.Bose.com/compliance

Bose Corporation 在此聲明本產品嚴格遵守 2017 無線電設備法規中的基本要求和所有其他適用的英國法規。您可以從以下位置找到完整的符合聲明：www.Bose.com/compliance

重要安全指示

不要在水邊使用此裝置。

只能用乾布清潔。

任何維修事宜均請向合格的人員諮詢。如果本裝置有任何損壞，均需進行維修，例如電源線或插頭受損；液體濺入或物體落入裝置內；本裝置受雨淋或受潮、不能正常工作或跌落。

警告/小心

- 請勿長時間在高音量下使用耳機。
 - 為了避免聽力受損，請以舒適、適度的音量使用耳機。
 - 先將裝置音量調低，然後再戴上耳機，之後再逐漸調高音量，直到達到舒適的聽覺效果。
- 切勿在駕車時將耳機用於接聽電話或其他用途。
- 切勿在無法聽到周圍的聲音即可能對自己或他人造成危險時使用耳機的「消噪」模式，例如在道路、工地或鐵路或其附近騎自行車或步行等，並須遵守與耳機使用相關的適用法律。
 - 關閉耳機，或將「消噪」功能關閉並調節音量，以保證能夠聽到周圍的聲音，包括報警和警報訊號。
 - 了解使用耳機時作為提醒或警告的聲音如何相應變化，即使在覺醒模式下。
- 如果耳機發出不正常的噪音，請勿使用。在此情況下，請關閉耳機，然後聯絡 Bose 客戶服務中心。
- 若您感覺到發熱或聽不到聲音，請立即取下耳機。
- 切勿使用手機配接器連接耳機和飛機座椅插孔，因為由此產生的高溫會導致人身傷害或財產損失。
- 請勿使用本耳機作為航空通訊耳機。



包含小零件，可能導致窒息危險。不適合 3 歲以下的兒童使用。



本產品含有磁性材料。諮詢醫生了解此裝置是否會影響植入式醫療裝置。

- 為了減少火災或電擊危險，請勿使本產品暴露在雨中，受液體淋濺、噴灑，或暴露在潮濕環境中，也不得將裝有液體的物體（如花瓶等）置於本產品上或本產品附近。
- 保持產品遠離火源和熱源。請勿將明火火源（如點燃的蠟燭）置於本產品上或靠近本產品。
- 僅將本產品搭配經過相關部門批准且符合本地監管要求（如 UL、CSA、VDE、CCC）的 LPS 電源供應器使用。
- 未經授權切勿擅自改裝本產品。
- 如果電池漏液，請避免讓液體與皮膚或眼睛接觸。如果接觸到了液體，請諮詢醫生。
- 請勿使含電池產品過熱（例如存放時請避免陽光直射並遠離火源等）。
- 請勿在充電時佩戴。

注意：本設備已經過測試，符合 FCC 規則第 15 部分有關 B 類數位裝置的各項限制。這些限制性規定旨在防範安裝在住宅中的裝置產生有害干擾。本設備產生、使用並可能發散無線射頻能量，如果不按照指示安裝和使用，則可能會對無線電通訊造成有害干擾。然而，按照指示安裝並不能保證某些安裝不會發生干擾。如果本設備確實對無線電或電視接收造成有害干擾（可透過關閉和開啟本設備來確定），使用者可嘗試採取以下一或多種措施來糾正干擾：

- 重新調整接收產品或天線的方向或位置。
- 增大本設備和接收器的間距。
- 將本設備和接收器電源線插入不同線路上的插座中。
- 請諮詢經銷商或有經驗的無線電/電視技術人員以獲得協助。

未經 Bose Corporation 明確批准，擅自變更或改裝本設備可能會使使用者操作本設備的授權失效。

本裝置符合 FCC 規則第 15 部分規定和加拿大 ISED 免許可證 RSS 標準。本裝置工作時應滿足下列兩種情形：(1) 本裝置不得造成有害干擾；(2) 本裝置必須承受任何接收到的干擾，包括可能造成裝置異常工作的干擾。

本裝置符合為公眾闡明的 FCC 和加拿大 ISED 輻射限制。本發射器不得與其他天線或發射器位於同一地點或同時運行。

符合 IMDA 要求。

FCC ID : A94437310

IC : 3232A-437310

CAN ICES-3(B)/NMB-3(B)

適用於歐洲：

工作頻帶 2400 至 2483.5 MHz。

最大傳輸功率低於 20 dBm EIRP。

最大傳輸功率低於監管限制，因此無需 SAR 測試並根據適用法規豁免。



此符號表示本產品不得作為家庭垃圾丟棄，應該送至相關回收部門循環利用。適當的處理和回收有助於保護自然資源、人類健康以及自然環境。想了解更多有關本產品的處理和回收資訊，請與當地民政部門、廢棄物處理服務機構或售出本產品的商店連絡。

低功率射頻器材技術規範

取得審驗證明之低功率射頻器材，非經核准，公司、商號或使用者均不得擅自變更頻率、加大功率或變更原設計之特性及功能。低功率射頻器材之使用不得影響飛航安全及干擾合法通信；經發現有干擾現象時，應立即停用，並改善至無干擾時方得繼續使用。前述合法通信，指依電信管理法規定作業之無線電通信。低功率射頻器材須忍受合法通信或工業、科學及醫療用電波輻射性電機設備之干擾。

請勿嘗試拆除產品內的可充電鋰離子電池。請聯絡本地 Bose 零售商或其他具有資格的专业人員以進行拆除。

本產品中的可充電鋰電池應只由具資格的專業人員進行拆除。如需更多資訊，請聯絡本地 Bose 零售商或瀏覽：products.bose.com/static/compliance/index.html。



請遵守本地法規，適當處理廢舊電池。請勿將其焚化。



有毒或有害物質或元素的名稱及成分						
零件名稱	有毒或有害物質或元素					
	鉛 (Pb)	汞 (Hg)	鎘 (Cd)	六價鉻 (CR(VI))	多溴化聯苯 (PBB)	多溴二苯醚 (PBDE)
印刷電路板	X	0	0	0	0	0
金屬零件	X	0	0	0	0	0
塑膠零件	0	0	0	0	0	0
揚聲器	X	0	0	0	0	0
連接線	X	0	0	0	0	0
此表格根據 SJ/T 11364 條款編製。 0：表示此零件中所有同類物質包含的有毒或有害物質低於 GB/T 26572 中的限定要求。 X：表示此零件使用的同類物質中至少有一種包含的有毒或有害物質高於 GB/T 26572 中的限定要求。						

生產日期：序號中第八位數字表示生產年份；「2」表示 2012 年或 2022 年。

中國進口商：博士視聽系統（上海）有限公司，上海市閔行區古岱路 2337 號 D 座 6 層，201100

歐盟進口商：Bose Products B.V., Gorslaan 60, 1441 RG Purmerend, The Netherlands

墨西哥進口商：Bose de México S. de R.L. de C.V., Avenida Prado Sur #150, Piso 2, Interior 222 y 223, Colonia Lomas de Chapultepec V Sección, Miguel Hidalgo, Ciudad de México, C.P.11000

電話：+5255 (5202) 3545

台灣進口商：Bose 台灣分公司 (H.K.)，台灣台北市民生東路三段 10 號，9F 10480

電話：+886-2-2514 7676

英國進口商：Bose Limited, Bose House, Quayside Chatham Maritime, Chatham, Kent, ME4 4QZ, United Kingdom

輸入額定：5 V --- 0.5 A

充電溫度範圍：0°C - 45°C

放電溫度範圍：-20°C - 60°C

型號 437310。CMIIT ID 位於基布下的耳罩內側。

請填寫以下內容，留作記錄

序號和型號位於基布下的耳罩內側。

序號：_____

型號：_____

請將收據連同使用者指南存放在一起。現在是註冊您的 Bose 產品的好機會。

您可以到 worldwide.bose.com/ProductRegistration 輕鬆完成註冊。

安全性資訊



連接 Bose Music 應用程式時，此產品能夠自動接收來自 Bose 的安全性更新。要透過行動應用程式接收安全性更新，您必須在 Bose Music 應用程式中完成產品設定流程。**如果您沒有完成設定流程，您需要透過以下網址自行安裝 Bose 屆時提供的安全性更新：btu.bose.com**

Apple、Apple 徽標、iPad、iPhone 以及 iPod 是 Apple Inc. 在美國和其他國家/地區註冊的商標。App Store 是 Apple Inc. 的服務標記。商標「iPhone」已獲得 Aiphone K.K. 在日本的使用授權。

使用「Apple 專用」標記表示此配件的設計專門用來連接標記中認定的 Apple 產品，並且通過了開發商的認證，符合 Apple 的效能標準。Apple 對此裝置的工作或其與安全和監管標準的合規性概不負責。

Bluetooth® 文字標記和標誌是由 Bluetooth SIG, Inc. 所擁有的註冊商標，Bose Corporation 對上述標記的任何使用都遵守授權規定。

Google Play 是 Google LLC 的商標。

USB Type-C® 和 USB-C® 是 USB Implementers Forum 的註冊商標。

Bose、Bose Home Speaker、Bose Music、Bose Music 徽標、Bose Smart Soundbar、Bose Smart Speaker、Bose Soundbar、QuietComfort 和 SimpleSync 是 Bose Corporation 的商標。

Bose 公司總部：1-877-230-5639

©2022 Bose Corporation。未經事先書面許可，不得複製、修改、發行或以其他方式使用本指南的任何部分。

The following license disclosures apply to certain third-party software packages used as components in the product.

Package: FreeRTOS

Copyright © Amazon Web Services, Inc. or its affiliates. All rights reserved.

The FreeRTOS package is subject to the license terms reprinted below:

MIT License

Permission is hereby granted, free of charge, to any person obtaining a copy of this software and associated documentation files (the “Software”), to deal in the Software without restriction, including without limitation the rights to use, copy, modify, merge, publish, distribute, sublicense, and/or sell copies of the Software, and to permit persons to whom the Software is furnished to do so, subject to the following conditions:

The above copyright notice and this permission notice shall be included in all copies or substantial portions of the Software.

THE SOFTWARE IS PROVIDED “AS IS”, WITHOUT WARRANTY OF ANY KIND, EXPRESS OR IMPLIED, INCLUDING BUT NOT LIMITED TO THE WARRANTIES OF MERCHANTABILITY, FITNESS FOR A PARTICULAR PURPOSE AND NONINFRINGEMENT. IN NO EVENT SHALL THE AUTHORS OR COPYRIGHT HOLDERS BE LIABLE FOR ANY CLAIM, DAMAGES OR OTHER LIABILITY, WHETHER IN AN ACTION OF CONTRACT, TORT OR OTHERWISE, ARISING FROM, OUT OF OR IN CONNECTION WITH THE SOFTWARE OR THE USE OR OTHER DEALINGS IN THE SOFTWARE.

Package: Nanopb

Copyright © 2011 Petteri Aimonen <jpa at nanopb.mail.kapsi.fi>.

The Nanopb package is subject to the license terms reprinted below:

Zlib License

© 2011 Petteri Aimonen <jpa at nanopb.mail.kapsi.fi>

This software is provided ‘as-is’, without any express or implied warranty. In no event will the authors be held liable for any damages arising from the use of this software.

Permission is granted to anyone to use this software for any purpose, including commercial applications, and to alter it and redistribute it freely, subject to the following restrictions:

1. The origin of this software must not be misrepresented; you must not claim that you wrote the original software. If you use this software in a product, an acknowledgment in the product documentation would be appreciated but is not required.
2. Altered source versions must be plainly marked as such, and must not be misrepresented as being the original software.
3. This notice may not be removed or altered from any source distribution.

Package: Mbed TLS 2.16.1

© ARM Limited. All rights reserved.

The Mbed TLS package is subject to the license terms reprinted below:

Apache License

Version 2.0, January 2004

<http://www.apache.org/licenses/>

TERMS AND CONDITIONS FOR USE, REPRODUCTION, AND DISTRIBUTION

1. Definitions.
“License” shall mean the terms and conditions for use, reproduction, and distribution as defined by Sections 1 through 9 of this document.

“Licensor” shall mean the copyright owner or entity authorized by the copyright owner that is granting the License.

“Legal Entity” shall mean the union of the acting entity and all other entities that control, are controlled by, or are under common control with that entity. For the purposes of this definition, “control” means (i) the power, direct or indirect, to cause the direction or management of such entity, whether by contract or otherwise, or (ii) ownership of fifty percent (50%) or more of the outstanding shares, or (iii) beneficial ownership of such entity.

“You” (or “Your”) shall mean an individual or Legal Entity exercising permissions granted by this License.

“Source” form shall mean the preferred form for making modifications, including but not limited to software source code, documentation source, and configuration files.

“Object” form shall mean any form resulting from mechanical transformation or translation of a Source form, including but not limited to compiled object code, generated documentation, and conversions to other media types.

“Work” shall mean the work of authorship, whether in Source or Object form, made available under the License, as indicated by a copyright notice that is included in or attached to the work (an example is provided in the Appendix below).

“Derivative Works” shall mean any work, whether in Source or Object form, that is based on (or derived from) the Work and for which the editorial revisions, annotations, elaborations, or other modifications represent, as a whole, an original work of authorship. For the purposes of this License, Derivative Works shall not include works that remain separable from, or merely link (or bind by name) to the interfaces of, the Work and Derivative Works thereof.

“Contribution” shall mean any work of authorship, including the original version of the Work and any modifications or additions to that Work or Derivative Works thereof, that is intentionally submitted to Licensor for inclusion in the Work by the copyright owner or by an individual or Legal Entity authorized to submit on behalf of the copyright owner. For the purposes of this definition, “submitted” means any form of electronic, verbal, or written communication sent to the Licensor or its representatives, including but not limited to communication on electronic mailing lists, source code control systems, and issue tracking systems that are managed by, or on behalf of, the Licensor for the purpose of discussing and improving the Work, but excluding communication that is conspicuously marked or otherwise designated in writing by the copyright owner as “Not a Contribution.”

“Contributor” shall mean Licensor and any individual or Legal Entity on behalf of whom a Contribution has been received by Licensor and subsequently incorporated within the Work.

2. Grant of Copyright License. Subject to the terms and conditions of this License, each Contributor hereby grants to You a perpetual, worldwide, non-exclusive, no-charge, royalty-free, irrevocable copyright license to reproduce, prepare Derivative Works of, publicly display, publicly perform, sublicense, and distribute the Work and such Derivative Works in Source or Object form.
3. Grant of Patent License. Subject to the terms and conditions of this License, each Contributor hereby grants to You a perpetual, worldwide, non-exclusive, no-charge, royalty-free, irrevocable (except as stated in this section) patent license to make, have made, use, offer to sell, sell, import, and otherwise transfer the Work, where such license applies only to those patent claims licensable by such Contributor that are necessarily infringed by their Contribution(s) alone or by combination of their Contribution(s) with the Work to which such Contribution(s) was submitted. If You institute patent litigation against any entity (including a cross-claim or counterclaim in a lawsuit) alleging that the Work or a Contribution incorporated within the Work constitutes direct or contributory patent infringement, then any patent licenses granted to You under this License for that Work shall terminate as of the date such litigation is filed.
4. Redistribution. You may reproduce and distribute copies of the Work or Derivative Works thereof in any medium, with or without modifications, and in Source or Object form, provided that You meet the following conditions:
 - a. You must give any other recipients of the Work or Derivative Works a copy of this License; and
 - b. You must cause any modified files to carry prominent notices stating that You changed the files; and
 - c. You must retain, in the Source form of any Derivative Works that You distribute, all copyright, patent, trademark, and attribution notices from the Source form of the Work, excluding those notices that do not pertain to any part of the Derivative Works; and

d. If the Work includes a “NOTICE” text file as part of its distribution, then any Derivative Works that You distribute must include a readable copy of the attribution notices contained within such NOTICE file, excluding those notices that do not pertain to any part of the Derivative Works, in at least one of the following places: within a NOTICE text file distributed as part of the Derivative Works; within the Source form or documentation, if provided along with the Derivative Works; or, within a display generated by the Derivative Works, if and wherever such third-party notices normally appear. The contents of the NOTICE file are for informational purposes only and do not modify the License. You may add Your own attribution notices within Derivative Works that You distribute, alongside or as an addendum to the NOTICE text from the Work, provided that such additional attribution notices cannot be construed as modifying the License.

You may add Your own copyright statement to Your modifications and may provide additional or different license terms and conditions for use, reproduction, or distribution of Your modifications, or for any such Derivative Works as a whole, provided Your use, reproduction, and distribution of the Work otherwise complies with the conditions stated in this License.

5. Submission of Contributions. Unless You explicitly state otherwise, any Contribution intentionally submitted for inclusion in the Work by You to the Licensor shall be under the terms and conditions of this License, without any additional terms or conditions. Notwithstanding the above, nothing herein shall supersede or modify the terms of any separate license agreement you may have executed with Licensor regarding such Contributions.
6. Trademarks. This License does not grant permission to use the trade names, trademarks, service marks, or product names of the Licensor, except as required for reasonable and customary use in describing the origin of the Work and reproducing the content of the NOTICE file.
7. Disclaimer of Warranty. Unless required by applicable law or agreed to in writing, Licensor provides the Work (and each Contributor provides its Contributions) on an “AS IS” BASIS, WITHOUT WARRANTIES OR CONDITIONS OF ANY KIND, either express or implied, including, without limitation, any warranties or conditions of TITLE, NON-INFRINGEMENT, MERCHANTABILITY, or FITNESS FOR A PARTICULAR PURPOSE. You are solely responsible for determining the appropriateness of using or redistributing the Work and assume any risks associated with Your exercise of permissions under this License.
8. Limitation of Liability. In no event and under no legal theory, whether in tort (including negligence), contract, or otherwise, unless required by applicable law (such as deliberate and grossly negligent acts) or agreed to in writing, shall any Contributor be liable to You for damages, including any direct, indirect, special, incidental, or consequential damages of any character arising as a result of this License or out of the use or inability to use the Work (including but not limited to damages for loss of goodwill, work stoppage, computer failure or malfunction, or any and all other commercial damages or losses), even if such Contributor has been advised of the possibility of such damages.
9. Accepting Warranty or Additional Liability. While redistributing the Work or Derivative Works thereof, You may choose to offer, and charge a fee for, acceptance of support, warranty, indemnity, or other liability obligations and/or rights consistent with this License. However, in accepting such obligations, You may act only on Your own behalf and on Your sole responsibility, not on behalf of any other Contributor, and only if You agree to indemnify, defend, and hold each Contributor harmless for any liability incurred by, or claims asserted against, such Contributor by reason of your accepting any such warranty or additional liability.

END OF TERMS AND CONDITIONS

©2022 Bose Corporation

Licensed under the Apache License, Version 2.0 (the “License”); you may not use this file except in compliance with the License.

You may obtain a copy of the License at: <http://www.apache.org/licenses/LICENSE-2.0>

Unless required by applicable law or agreed to in writing, software distributed under the License is distributed on an “AS IS” BASIS, WITHOUT WARRANTIES OR CONDITIONS OF ANY KIND, either express or implied.

See the License for the specific language governing permissions and limitations under the License.

裝箱單

內件	13
----------	----

BOSE MUSIC 應用程式

下載 Bose Music 應用程式.....	14
將耳機新增至現有帳戶.....	14

耳機控制項

開啟電源	16
待命計時器.....	16
關閉電源	17
耳機功能.....	18
媒體播放和音量.....	18
通話.....	19
動作按鈕.....	20

消噪

消噪模式.....	21
變更消噪模式.....	21

語音控制項

使用語音控制項.....	22
--------------	----

BLUETOOTH® 連接

使用行動裝置上的 Bluetooth 功能表連接.....	23
斷開行動裝置.....	25
重新連接行動裝置.....	25
連接另一台行動裝置.....	25
識別已連接的行動裝置.....	25
在兩台已連接的行動裝置之間切換.....	25
重新連接之前曾連接過的裝置.....	26
清空耳機的裝置清單.....	26

有線連接

連接音訊連接線.....	27
--------------	----

電池

為耳機充電.....	28
充電時間.....	28
收聽電池電量.....	28

耳機狀態

<i>Bluetooth</i> 狀態.....	29
電池狀態.....	29
充電狀態.....	30
更新和錯誤狀態.....	30

連接 BOSE 產品

連接 Bose Smart Speaker 或 Soundbar.....	31
優點.....	31
相容產品.....	31
使用 Bose Music 應用程式連接.....	31
重新連接 Bose Smart Speaker 或 Soundbar.....	32

維護與保養

存放耳機.....	33
清潔耳機.....	34
更換零件和配件.....	34
有限保固.....	34
序號位置.....	35

疑難排解

首先嘗試這些解決方案..... 36

其他解決方案..... 36

將耳機還原為出廠設定..... 39

內件

請確認包裝箱中內含以下零件：



Bose QuietComfort 45 耳機

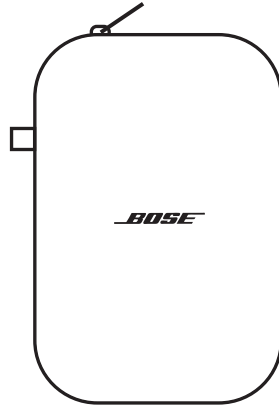

軟便攜包

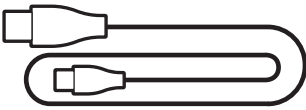

USB Type-C® 連接線

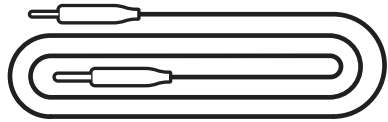

3.5 公釐至 2.5 公釐音訊連接線

注意：如果產品部分損壞，請勿使用。請連絡 Bose 授權經銷商或 Bose 客戶服務中心。

請造訪：support.Bose.com/QCSE

您可在任何行動裝置（例如智慧型手機或平板電腦）上透過 Bose Music 應用程式設定和控制耳機。

您可以使用此應用程式管理 *Bluetooth* 連接、管理耳機設定、選擇自己的語音提示語言及透過更新存取新功能。

注意：如果您已為其他 Bose 產品建立了 Bose 帳戶，請將耳機新增至現有的帳戶（請參見第 14 頁的底部）。

下載 BOSE MUSIC 應用程式

1. 在行動裝置上，下載 Bose Music 應用程式。

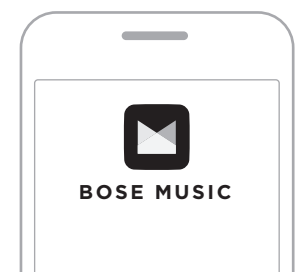

2. 請按照應用程式指示操作。

將耳機新增至現有帳戶

要新增 Bose QuietComfort 45 耳機，請開啟 Bose Music 應用程式並新增耳機。

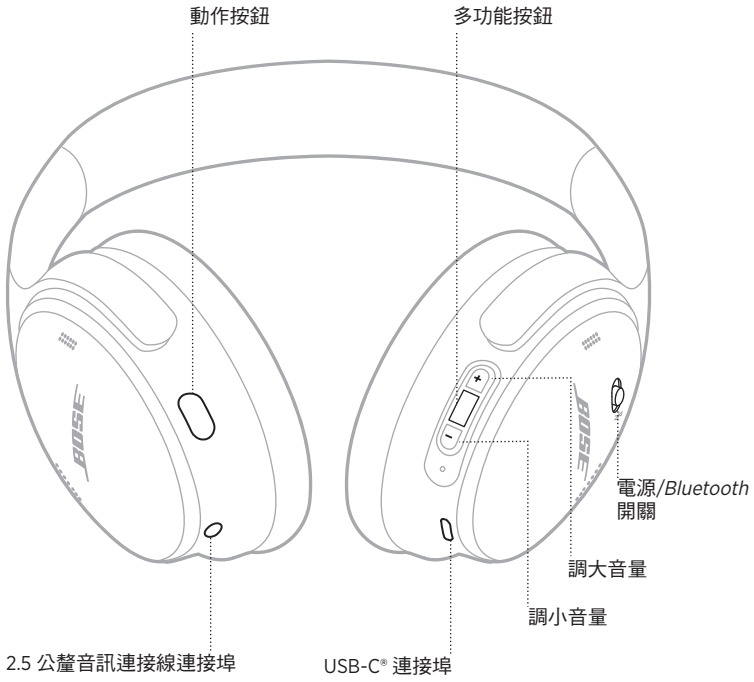

開啟電源

在右耳罩上，將「電源/Bluetooth」開關滑動至右側。

語音提示播報電池電量，電池指示燈依據目前的充電電量亮起（請參見第 29 頁）。



待命計時器

耳機未使用時待命計時器可節省電池電量。

請使用 Bose Music 應用程式，設定並自訂待命計時器。

關閉電源

將「電源/Bluetooth」開關滑到左側。



注意：關閉耳機電源後，將停用消噪。

耳機功能

耳機控制項位於右耳罩的背面。

媒體播放和音量

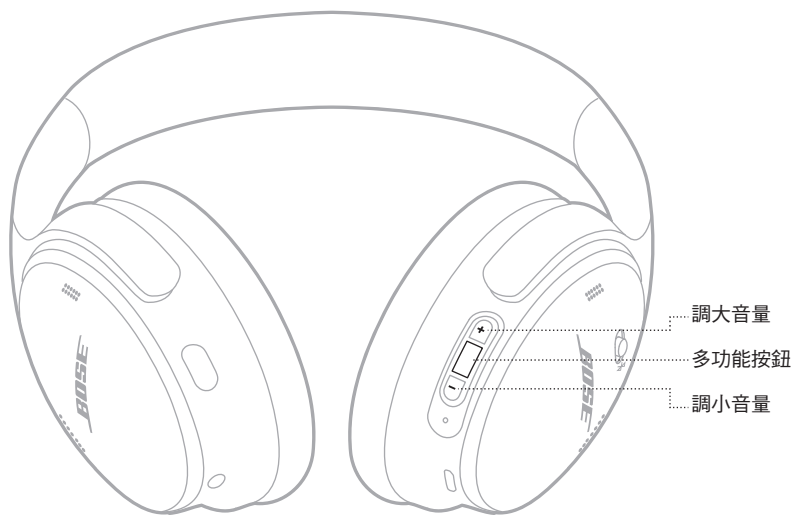

功能	操作方法
播放/暫停	按下多功能按鈕。
前進	連按兩下多功能按鈕。
倒轉	連按三下多功能按鈕。
調大音量	按下 +。
調小音量	按下 -。

注意：

- 要快速提高音量，按住 +。
- 要快速降低音量，按住 -。

通話

多功能按鈕位於右耳罩的背面。麥克風位於右耳罩的正面附近。

動作按鈕位於左方耳罩的背面。

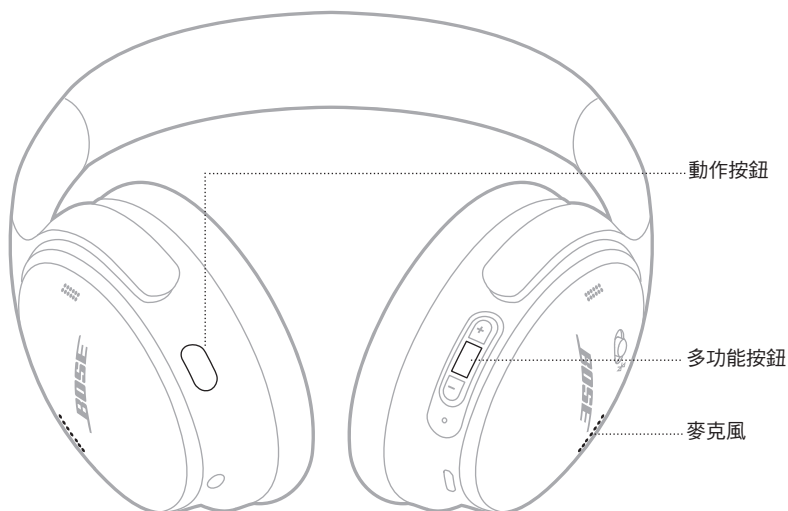

功能	操作方法
接聽/結束通話	按下多功能按鈕。
拒絕接聽來電	按住多功能按鈕 1 秒。
接聽第二次來電並保持目前來電	第一通來電通話中且第二通來電正在響鈴時，按下多功能按鈕。
拒絕第二通來電並保留目前的通話	第一通來電通話中且第二通來電正在響鈴時，按住多功能按鈕 1 秒。
在兩次通話之間切換	當同時接通兩通通話時，連按兩下多功能按鈕。
建立會議通話	當同時接通兩通通話時，按住多功能按鈕 3 秒。
靜音/取消靜音	當接通一通通話時，連按兩下動作按鈕。

動作按鈕

您可以使用動作按鈕快速輕鬆地在消噪模式之間切換。

動作按鈕位於左方耳罩的背面。

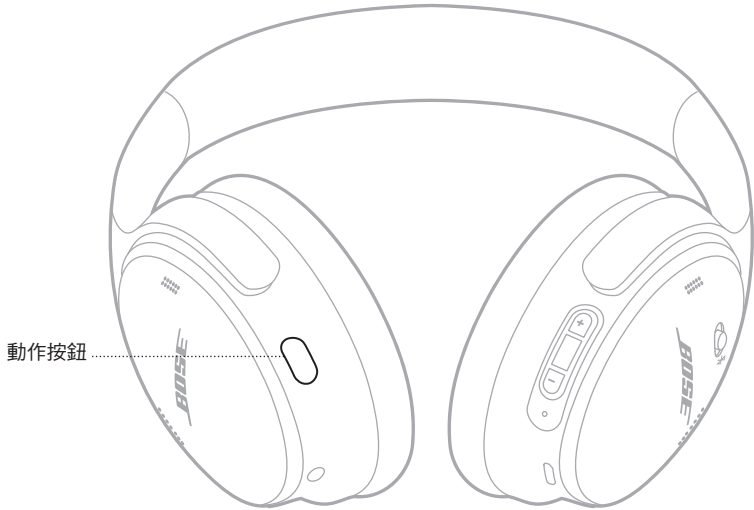

要在安靜模式和感知外界模式之間切換，請按下動作按鈕。

有關消噪模式的更多資訊，請參見第 21 頁。

消噪可以減少不需要的噪音，提供更清晰且更逼真的音訊效能。可以選擇兩種消噪模式：安靜和感知外界。

安靜模式可以使用最高的消噪級別來防止干擾。

感知外界模式以完全通透的形式，讓您在享受音訊的同時還能聽到周圍環境的聲音。

根據收聽偏好和環境選擇消噪模式。

消噪模式

模式	說明
安靜	頂級消噪，可提供 Bose 最佳化音訊。
感知外界	在享受音訊的同時聽清周圍環境的聲音。

注意：打開電源後，耳機將會預設為您啟用上一次的模式。

變更消噪模式

要變更消噪模式，請按下動作按鈕。

語音提示播報選定的消噪模式。

提示：您還可使用 Bose Music 應用程式變更消噪模式。

使用語音控制項

您可以使用耳機使用行動裝置上的語音控制項。要使用語音控制項，按住多功能按鈕1秒。

多功能按鈕位於右耳罩的背面。

注意：通話時無法使用語音控制項。

使用行動裝置上的 **BLUETOOTH** 功能表連接

耳機的裝置清單中最多儲存八台裝置，並且耳機一次可以主動連接兩台裝置。您一次只能播放一台裝置的音訊。

注意：要獲得最佳體驗，請使用 Bose Music 應用程式設定及連接行動裝置（請參見第 14 頁）。

1. 將「電源/Bluetooth」開關滑至右側  並按住 3 秒。

您將聽到「Ready to connect」(準備連接)，且狀態指示燈閃爍藍色光。



2. 在裝置上，啟用 *Bluetooth* 功能。

注意：*Bluetooth* 功能通常可在「設定」功能表中找到。

3. 從裝置清單中選取您的耳機。

提示：在 Bose Music 應用程式中查找您為耳機輸入的名稱。如果沒有為耳機命名，將顯示預設名稱。



連接後，您會聽到「Connected to <device name> (已連接 < 行動裝置名稱 >)」，狀態指示燈恆亮藍色光。

斷開行動裝置

使用 Bose Music 應用程式來斷開行動裝置。

提示：您也可使用 *Bluetooth* 設定斷開裝置。停用 *Bluetooth* 功能後，所有其他裝置連接都將中斷。

重新連接行動裝置

開啟電源時，耳機將嘗試與兩台最近連接的裝置重新建立連接。

注意：

- 裝置必須在連接範圍內（9 公尺）且已開啟電源。
- 請確定您的行動裝置已啟用 *Bluetooth* 功能。

連接另一台行動裝置

要連接另一台裝置，請下載 Bose Music 應用（請參見第 14 頁）或使用行動裝置上的 *Bluetooth* 功能表（請參見第 23 頁）。

注意：您一次只能播放一台裝置的音訊。

識別已連接的行動裝置

將「電源/*Bluetooth*」開關滑到右側 ✱ 並釋放即可聽到目前連接的是哪台裝置。

在兩台已連接的行動裝置之間切換

1. 暫停第一台行動裝置的音訊。
2. 播放第二台行動裝置的音訊。

注意：無論哪台裝置播放音訊，您的耳機可以接聽兩台裝置上的通話。

重新連接之前曾連接過的裝置

1. 將「電源/Bluetooth」開關滑到右側 ✧ 並釋放即可聽到連接的是哪台裝置。
2. 在 2 秒內再次將「電源/Bluetooth」開關滑到右側 ✧ 並釋放即可連接至耳機的裝置清單中的下一台裝置。
3. 重複，直到聽到正確的裝置名稱為止。
您會聽到表示裝置已連接的提示音。
4. 播放連接的行動裝置的音訊。

注意：如果有兩台裝置已經連接至耳機，新連接的裝置將取代之前連接的第二台裝置。

清空耳機的裝置清單

1. 將「電源/Bluetooth」開關滑到 ✧ 右側並按住 15 秒，直至聽到「Bluetooth device list cleared. Ready to connect.」(Bluetooth 裝置清單已清空。準備連接。)
2. 從行動裝置的 Bluetooth 清單中刪除您的耳機。
所有裝置被刪除，耳機可開始連接。

連接音訊連接線

如果電池電量已耗盡，使用 2.5 公釐至 3.5 公釐連接線連接非無線裝置或繼續使用耳機。

1. 將連接線連接至左耳罩上的 2.5 公釐連接埠中。

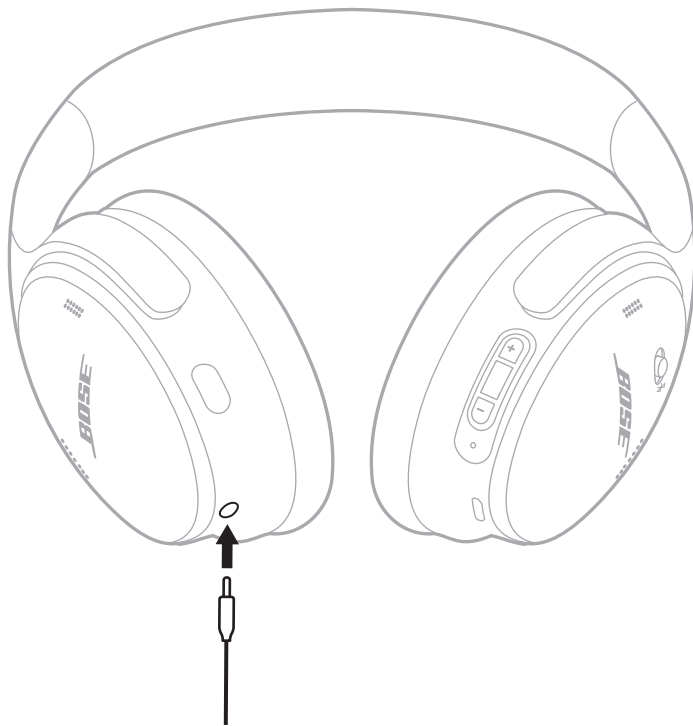

2. 將連接線的另一端連接至裝置上的 3.5 公釐連接埠中。

注意：當已連接音訊線時，可以使用耳機來打開或關閉電源。

為耳機充電

1. 請將 USB 連接線的較小端連接至右耳罩上的 USB-C 連接埠。
2. 將另一端連接至 USB 壁式充電器。



注意：

- 當耳機開始充電時，狀態指示燈閃爍白色光 10 秒。充滿電後，狀態燈呈恆亮白色光亮起。
- 充電時耳機無法播放。

充電時間

最長需要 2.5 小時即可將耳機充滿電。

收聽電池電量

每次開啟耳機電源時，語音提示即會播報電池電量。如果耳機電池電量不足，您會聽到「Battery low, please charge now.」(電池電量低，請立即充電)。

注意：若要目測檢查電池電量，請查看位於右耳罩的狀態指示燈。有關更多資訊，請參見第 29 頁上的「電池狀態」。

狀態指示燈位於右耳罩上。



BLUETOOTH 狀態

顯示 Bluetooth 連接狀態。

指示燈活動	系統狀態
閃爍的藍色光	準備連接
恆亮藍色光 (10 秒)	已連接

電池狀態

顯示電池電量。

指示燈活動	系統狀態
恆亮白色光	中等到完全充電
琥珀色光恆亮	低電量

提示：您也可使用 Bose Music 應用程式檢查電池電量。

充電狀態

顯示充電狀態。

指示燈活動	系統狀態
閃爍白色光 2 次	充電開始
琥珀色光恆亮	正在充電
恆亮白色光	完全充滿

更新和錯誤狀態

顯示更新或錯誤狀態。

指示燈活動	系統狀態
快速閃爍的白色光 (10 秒)	正在更新軟體 (透過 USB)
緩慢閃爍白色光 (30 至 60 秒)	正在更新軟體 (無線)
閃爍琥珀色光和白色光	錯誤 —— 聯絡 Bose 客戶服務中心

連接 BOSE SMART SPEAKER 或 SOUNDBAR

採用 SimpleSync™ 技術後，您可以將耳機連接至 Bose Smart Soundbar 或 Bose Smart Speaker，享受個人化的聆聽體驗。

優點

- 透過每種產品的獨立音量控制項，在您將 Bose Smart Soundbar 的音量調低或調成靜音的同時，耳機聆聽的音量可以隨您喜愛，要多大聲就多大聲。
- 將您的 Bose 耳機連接至 Bose Smart Speaker，即可在另一個房間清晰地聆聽音樂。

注意：SimpleSync™ 技術的 *Bluetooth* 連接範圍為 9 公尺。牆壁或建材可能會影響接收效能。

相容產品

您可以將耳機連接至任何 Bose Smart Speaker 或 Bose Smart Soundbar。

熱門的相容產品包括：

- Bose Smart Soundbar 700/Bose Soundbar 700
- Bose Soundbar 500
- Bose Smart Speaker 500/Bose Home Speaker 500
- Bose Home Speaker 300
- Bose Portable Smart Speaker/Bose Portable Home Speaker

新產品將定期新增。如需完整清單和更多資訊，請造訪：
worldwide.Bose.com/Support/Groups

使用 Bose Music 應用程式連接

1. 將耳機上的「電源/*Bluetooth*」開關滑到右側 ✧ 並按住 3 秒。

您會聽到「Ready to connect another device」(準備連接另一台裝置)，然後狀態指示燈閃爍藍色光。

2. 使用 Bose Music 應用程式將耳機連接至相容的 Bose 產品。如需詳細資訊，請造訪：worldwide.Bose.com/Support/Groups

注意：

- 確定耳機在條形音箱或揚聲器的 9 公尺連接範圍內。
- 您一次只能將耳機連接至一種產品。

重新連接 BOSE SMART SPEAKER 或 SOUNDBAR

開啟耳機電源（請參見第 16 頁上的「開啟電源」）。

耳機會嘗試連接到最近連接的兩台 *Bluetooth* 裝置，包括條形音箱或揚聲器。

注意：

- 條形音箱或揚聲器必須在連接範圍內（9 公尺）且已開啟電源。
- 如果無法重新連接耳機，請參見第 38 頁上的「耳機無法重新連接先前已連接的 Bose Smart Soundbar 或 Speaker」。

存放耳機

將耳罩旋轉以便於儲存。將耳機平放入盒中。

1. 向內旋轉兩個耳罩，將其放平。



2. 將左耳罩向上向頭帶方向摺疊。

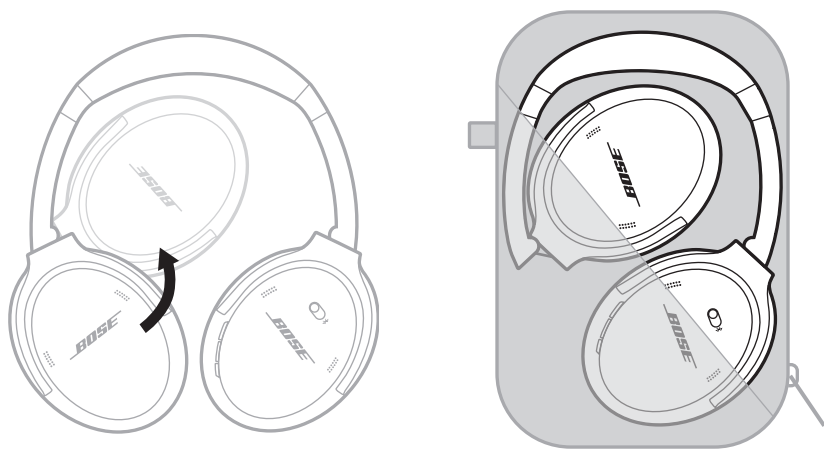

注意：

- 不使用時，請確定關閉耳機。
- 長期存放耳機之前，請確保電池電量充滿。

清潔耳機

用柔軟的乾布擦拭耳機表面。

不要讓水汽進入耳罩。

更換零件和配件

可透過 Bose 客戶服務中心訂購更換零件和配件。

請造訪：support.Bose.com/QCSE

有限保固

您的耳機享受有限保固。有關有限保固的詳細資訊，請造訪我們的網站：worldwide.Bose.com/Warranty。

要註冊您的產品，請造訪 worldwide.Bose.com/ProductRegistration 以取得說明。未執行註冊並不影響您的有限保固權利。

序號位置

序號位於基布下的右耳罩內側。基布是蓋住和保護耳罩內元件的內側隔布。

要查看序號，握住基布上緣並輕輕撕開。

小心：注意切勿按壓或取下耳罩內的任何其他元件，否則會損壞耳機。

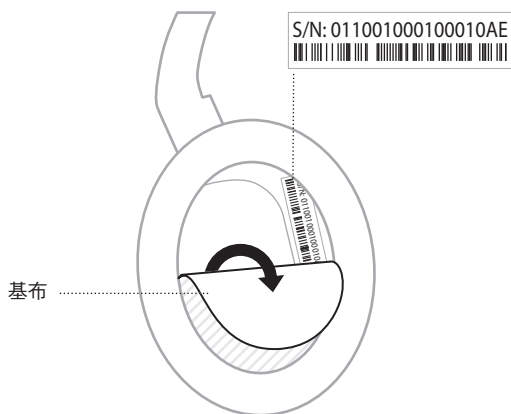

首先嘗試這些解決方案

如果耳機出現問題：

- 檢查狀態指示燈的狀態（請參見第 29 頁）。
- 為電池充電（請參見第 28 頁）。
- 調高您的耳機、行動裝置和音樂應用程式的音量。
- 下載 Bose Music 應用程式並運行可用的軟體更新（請參見第 14 頁）。
- 嘗試連接其他行動裝置（請參見第 25 頁）。

若無法解決問題，請參見下表了解常見問題的症狀和解決方法。若仍然無法解決問題，請連絡 Bose 客戶服務中心。

請造訪：worldwide.Bose.com/contact

其他解決方案

症狀	解決方案
耳機無法啟動	給電池充電。
耳機未與行動裝置連接	<p>斷開備用音訊連接線。</p> <p>斷開 USB 充電連接線。</p> <p>在您的行動裝置上：</p> <p>停用 <i>Bluetooth</i> 功能並重新啟用。</p> <p>從裝置上的 <i>Bluetooth</i> 清單中刪除您的 Bose QuietComfort 45 耳機，包括任何標有 LE（低能量）的重複清單。再次連接。</p> <p>將行動裝置靠近耳機，遠離其他干擾或障礙物。</p> <p>造訪 support.Bose.com/QCSE 查看說明視訊。</p> <p>清空已連接裝置清單（請參見第 26 頁）並再次連接。</p>
電池不充電	<p>固定 USB 充電線的末端。</p> <p>嘗試其他充電源。</p> <p>如果您的耳機曾被暴露在高溫或低溫環境中，等待耳機恢復室溫，然後再次充電。</p>

症狀	解決方案
<p>沒有聲音</p>	<p>打開耳機電源，然後為電池充電。</p> <p>檢查狀態指示燈的狀態（請參見第 29 頁）。</p> <p>將「電源/<i>Bluetooth</i>」開關滑到右側並釋放即可聽到已連接裝置。確認您使用的是正確的裝置。</p> <p>將行動裝置靠近耳機，遠離其他干擾或障礙物。</p> <p>使用不同的音樂來源。</p> <p>如果連接了兩台行動裝置，先暫停另一台裝置。</p> <p>如果連接了兩台行動裝置，將裝置移到耳機連接範圍內（9 公尺）。</p> <p>嘗試行動裝置上本機存放區的音樂或視訊檔案。</p>
<p>音質差</p>	<p>使用不同的音樂來源。</p> <p>連接其他行動裝置（請參見第 25 頁）。</p> <p>斷開第二台裝置。</p> <p>將行動裝置靠近耳機，遠離其他干擾或障礙物。</p> <p>嘗試行動裝置上本機存放區的音樂或視訊檔案。</p>
<p>從使用備用音訊連接線連接的裝置中聽不到聲音</p>	<p>固定備用音訊連接線的末端。</p> <p>調高耳機、行動裝置和音樂源的音量。</p> <p>連接另一台裝置（請參見第 25 頁）。</p>
<p>透過音訊連接線連接的裝置的聲音品質差</p>	<p>固定備用音訊連接線的末端。</p> <p>連接另一台裝置（請參見第 25 頁）。</p>
<p>「動作」按鈕無法變更消噪模式</p>	<p>請確保耳機的電源已經打開。</p> <p>使用 Bose Music 應用程式變更消噪模式。</p>

症狀	解決方案
<p>耳機無法連接至 Bose Smart Soundbar 或 Speaker</p>	<p>滑動並按住「電源/<i>Bluetooth</i>」按鈕，直到聽到「Ready to connect another device」(準備連接另一台裝置)，並且 <i>Bluetooth</i> 指示燈閃爍藍色光。</p> <p>確定耳機在條形音箱或揚聲器的 9 公尺連接範圍內。</p>
<p>耳機無法重新連接先前已連接的 Bose Smart Soundbar 或 Speaker</p>	<p>重新連接先前已連接的裝置 (請參見第 26 頁)。</p>
<p>連接至 Bose Smart Soundbar 或 Speaker 時音訊延遲</p>	<p>下載 Bose Music 應用程式並運行可用的軟體更新。</p>

還原出廠設定可以清除所有設定，使耳機還原到開箱時的原始狀態。之後，耳機可以像首次設定那樣進行配置。

只有當您的耳機出現問題，或者 Bose 客戶服務中心指示您這樣做時，才建議還原出廠設定。

將耳機還原為出廠設定

1. 從裝置的 *Bluetooth* 清單中移除耳機。
2. 使用 BoseMusic 應用程式將耳機從您的 Bose 帳戶中移除。

注意：關於如何使用 Bose Music 應用程式從您的 Bose 帳戶中移除耳機的更多資訊，請造訪 support.Bose.com/QCSE

3. 將「電源/*Bluetooth*」開關滑到右側 ✦ 並按住。同時，按住動作按鈕 30 秒。
狀態指示燈會閃爍白色光。30 秒後狀態指示燈閃爍琥珀色，表示正在還原出廠設定（2 至 3 秒）。
4. 還原完成後，狀態指示燈緩慢閃爍藍色光。耳機現在處於開箱後的原始狀態。

安全およびセキュリティ上の留意項目および使用方法をよく読み、それに従ってください。

CE Bose Corporationは、この製品がEU指令2014/53/EUおよび該当するその他すべてのEU指令の必須要件およびその他の該当条項に準拠していることを宣言します。完全な適合宣言書については、次のサイトを参照してください。www.Bose.com/compliance

UK CA この製品は、すべての適用される電磁両立規則2016およびその他すべての適用される英国の規制に準拠しています。完全な適合宣言書については、次のサイトを参照してください。www.Bose.com/compliance

Bose Corporationはここに、この製品が無線機器規則2017の必須要件およびその他すべての適用される英国の規制に準拠していることを宣言します。完全な適合宣言書については、次のサイトを参照してください。www.Bose.com/compliance

安全上の留意項目

この製品を水の近くで使用しないでください。

お手入れは乾いた布を使用して行ってください。

修理が必要な際には、Boseカスタマーサービスにお問い合わせください。製品に何らかの損傷が生じた場合、たとえば電源コードやプラグの損傷、液体や物の内部への侵入、雨や湿気などによる水濡れ、動作の異常、製品本体の落下などの際には、ただちに電源プラグを抜き、修理をご依頼ください。

警告/注意

- 大きな音量で長時間続けて聴かないでください。
 - ヘッドホンを使用する場合は、耳に負担をかけないように適度な音量に調節してください。
 - 再生機器の音量を下げてからヘッドホンを耳に装着し、適度な音量になるまで少しずつ音量を上げてください。
- 車両を運転しているときは、ヘッドホンを使用して電話をかけたり音楽を聴いたりしないでください。
- 自転車に乗っているときや、車道、建設現場、線路などの付近を歩いているときなど、外部音が聞こえないことによって自身や他の人に危険が生じる可能性がある場合は、ノイズキャンセリング機能付きヘッドホンを使用しないでください。
 - アラームや警告音などの周囲の音が聞こえるように、ヘッドホンの電源をオフにするか、ノイズキャンセリング機能をオフにして音量を下げてヘッドホンをお使いください。
 - ヘッドホンを使用しているときは、ノイズキャンセリング機能を弱めていても確認や注意喚起の音が普段と異なった感じで聞こえることがありますので、ご注意ください。
- ヘッドホンから異常な音が聞こえる場合は、ヘッドホンを使用しないでください。そのような場合は、ヘッドホンの電源をオフしてBoseカスタマーサービスにご連絡ください。
- 熱を感じた場合、または音声がかえなくなった場合には、すぐにヘッドホンを外してください。
- ヘッドホンを飛行機の座席端子に接続する際は、携帯電話用のアダプターは使用しないでください。使用した場合、怪我や過熱による物的損害が発生する恐れがあります。
- このヘッドホンを航空通信用ヘッドホンとして使用しないでください。



のどに詰まりやすい小さな部品が含まれています。3歳未満のお子様には適していません。



この製品には磁性材料が含まれています。体内に埋め込まれている医療機器への影響については、医師にご相談ください。

- 火災や感電を避けるため、雨や水滴、飛沫、湿気などにさらされるような場所で本製品を使用しないでください。また、花瓶などの液体が入った物品を本製品の上や近くに置かないでください。
- 火気や熱源などの近くで使用しないでください。火の付いたろうそくなどの火気を、製品の上や近くに置かないでください。
- この製品には、法令(UL、CSA、VDE、CCCなど)に準拠したLPS電源アダプターのみをお使いください。
- 許可なく製品を改造しないでください。
- バッテリーが液漏れしている場合は、漏れた液に触れたり目に入れたりしないでください。液が身体に付着した場合は、医師の診断を受けてください。
- バッテリーが含まれる製品を直射日光や炎など、過度な熱にさらさないでください。
- 充電中は装着しないでください。

注: 本機は、FCC規則のパート15に定められたクラスBデジタル装置の規制要件に基づいて所定の試験が実施され、これに準拠することが確認されています。この規制要件は、住宅に設置した際の有害な干渉に対し、合理的な保護となるように策定されています。本機は無線周波数エネルギーを発生、利用、また放射することがありますので、指示どおりに設置および使用されない場合は、無線通信に有害な電波干渉を引き起こす可能性があります。しかし、特定の設置条件で干渉が発生しないことを保証するものではありません。本機が、電源のオン・オフによりラジオ・テレビ受信に有害な干渉を引き起こしていることと確認された場合、次の1つあるいはいくつかの方法で対処を試みることをおすすめします。

- 受信機やアンテナの向きや位置を変える。
- 本機と受信機の距離を離す。
- 受信機の接続されているコンセントとは別の回路のコンセントに本機を接続する。
- 販売店もしくは経験豊富なラジオ・テレビ技術者に相談する。

Bose Corporationによって明確な許諾を受けていない本製品への変更や改造を行うと、この機器を使用するユーザーの権利が無効になります。

このデバイスは、FCC規則のパート15およびカナダイノベーション・科学経済開発省のライセンス適用免除RSS規則に準拠しています。動作は次の2つの条件に従う必要があります: (1) 本装置は有害な干渉を引き起こしません。(2) 本装置は、不適切な動作を招く可能性がある干渉を含め、いかなる干渉も対応できなければなりません。

このデバイスは、FCCおよびカナダイノベーション・科学経済開発省が一般用途向けに定めた電磁波放出制限に準拠しています。このトランスミッターは、他のアンテナまたはトランスミッターと一緒に配置したり、動作させたりしないでください。

この製品はIMDAの要件に適合しています。

FCC ID: A94437310

IC: 3232A-437310

CAN ICES-3(B)/NMB-3(B)

ヨーロッパ向け:

運用周波数帯: 2400 ~ 2483.5MHz

最大送信出力0dBm EIRP 未滿

最大送信出力が規制値を下回っているため、SARテストは不要で、適用される規制ごと免除されます。



この記号は、製品が家庭ごみとして廃棄されてはならず、リサイクル用に適切な収集施設に送る必要があることを意味しています。適切な廃棄とリサイクルにより、自然資源、人体の健康、環境が保護されることとなります。本製品の廃棄およびリサイクルに関する詳細は、お住まいの自治体、廃棄サービス、または本製品を購入された店舗にお問い合わせください。

低電力無線デバイスに関する技術規則

会社、企業、またはユーザーは、NCCの許可なく、承認済みの低電力無線デバイスの周波数を変更したり、送信出力を強化したり、元の特性および性能を改変したりすることはできません。低電力無線デバイスが、航空機の安全に影響を及ぼしたり、正規の通信を妨害したりすることはできません。発見された場合、ユーザーは干渉が発生しなくなるまでただちに使用を中止しなければなりません。上述の正規の通信とは、電気通信管理法に基づいて運用される無線通信を意味します。低電力無線デバイスは、正規の通信またはISM帯電波を放射するデバイスからの干渉に対応できなければなりません。

この製品からリチウムイオンバッテリーを取り外さないでください。取り外しはサービス担当者にお任せください。

この製品の充電式リチウムイオンバッテリーの取り外しはサービス担当者にお任せください。詳細につきましては、弊社Webサイトを参照してください。



使用済みの電池は、お住まいの地域の条例に従って正しく処分してください。焼却しないでください。



有毒/有害物質または成分の名称および含有量

パーツ名	有毒/有害物質および成分					
	鉛 (Pb)	水銀 (Hg)	カドミウム (Cd)	六価クロム (CR(VI))	ポリ臭化ビフェニル (PBB)	ポリ臭化ジフェニルエーテル (PBDE)
PCB	X	0	0	0	0	0
金属パーツ	X	0	0	0	0	0
プラスチックパーツ	0	0	0	0	0	0
スピーカー	X	0	0	0	0	0
ケーブル	X	0	0	0	0	0
この表はSJ/T 11364の規定に従って作成されています。 O: このパーツに使用されているすべての均質物質に含まれている当該有害/有害物質が、GB/T 26572の制限要件を下回っていることを示します。 X: このパーツに使用されている1種類以上の均質物質に含まれている当該有害/有害物質が、GB/T 26572の制限要件を上回っていることを示します。						

製造日: シリアル番号の8桁目の数字は製造年を表します。「2」は2012年または2022年です。

中国における輸入元: Bose Electronics (Shanghai) Company Limited, Level 6, Tower D, No. 2337 Gudai Rd. Minhang District, Shanghai 201100

EUにおける輸入元: Bose Products B.V., Gorslaan 60, 1441 RG Purmerend, The Netherlands

メキシコにおける輸入元: Bose de México S. de R.L. de C.V., Avenida Prado Sur #150, Piso 2, Interior 222 y 223, Colonia Lomas de Chapultepec V Sección, Miguel Hidalgo, Ciudad de México, C.P. 11000 電話番号: +5255 (5202) 3545

台湾における輸入元: Bose Limited Taiwan Branch (H.K.), 9F., No. 10, Sec.3, Minsheng E. Road, Zhongshan Dist. Taipei City 10480、台湾 電話番号: +886-2-2514 7676

英国における輸入元: Bose Limited, Bose House, Quayside Chatham Maritime, Chatham, Kent, ME4 4QZ, United Kingdom

入力定格: 5V ≡ 0.5A

充電時の温度範囲: 0°C ~ 45°C (32°F ~ 113°F)

バッテリー使用時の温度範囲: -20°C ~ 60°C (-4°F ~ 140°F)

モデル437310. CMIIT IDはイヤークップ内側のスクリーンの下に記載されています。

製品情報の控え

シリアル番号とモデル番号は、イヤークップ内側のスクリーンの下に記載されています。

シリアル番号: _____

モデル番号: _____

この取扱説明書と共に、ご購入時の領収書を保管することをおすすめします。製品の登録をお願いいたします。登録は弊社Webサイト (worldwide.Bose.com/ProductRegistration) から簡単に行えます。

セキュリティ情報



この製品は、Bose Music アプリに接続したときに Bose からセキュリティアップデートを自動的に受信することができます。モバイルアプリケーションを介してセキュリティアップデートを受信するには、Bose Music アプリで製品のセットアップを完了する必要があります。**セットアップを完了していない場合は、btu.bose.com で Bose が公開するセキュリティアップデートをお客様ご自身でインストールする必要があります。**

Apple、Apple のロゴ、iPad、iPhone、および iPod は Apple Inc. の商標であり、アメリカ合衆国および他の国々で登録されています。App Store は Apple Inc. のサービスマークです。「iPhone」の商標は、アイホン株式会社のライセンスに基づき日本国内で使用されています。

Made for Apple バッジの使用は、アクセサリがバッジに記載されている Apple 製品への接続専用に設計され、Apple 社が定める性能基準に適合しているとデベロッパによって認定されていることを示します。Apple 社は、本製品の動作や、安全性および規制基準の適合性について、一切の責任を負いません。

Bluetooth® のワードマークとロゴは、Bluetooth SIG, Inc. が所有する登録商標で、Bose Corporation はこれらの商標を使用する許可を受けています。

Google Play は、Google LLC の商標です。

USB Type-C® および USB-C® は、USB Implementers Forum の登録商標です。

Bose、Bose Home Speaker、Bose Music、Bose Music のロゴ、Bose Smart Soundbar、Bose Smart Speaker、Bose Soundbar、QuietComfort、および SimpleSync は、Bose Corporation の商標です。

Bose Corporation Headquarters: 1-877-230-5639

©2022 Bose Corporation. 本書のいかなる部分も、書面による事前の許可のない複写、変更、配布、その他の使用は許可されません。

The following license disclosures apply to certain third-party software packages used as components in the product.

Package: FreeRTOS

Copyright © Amazon Web Services, Inc. or its affiliates. All rights reserved.

The FreeRTOS package is subject to the license terms reprinted below:

MIT License

Permission is hereby granted, free of charge, to any person obtaining a copy of this software and associated documentation files (the "Software"), to deal in the Software without restriction, including without limitation the rights to use, copy, modify, merge, publish, distribute, sublicense, and/or sell copies of the Software, and to permit persons to whom the Software is furnished to do so, subject to the following conditions:

The above copyright notice and this permission notice shall be included in all copies or substantial portions of the Software.

THE SOFTWARE IS PROVIDED "AS IS", WITHOUT WARRANTY OF ANY KIND, EXPRESS OR IMPLIED, INCLUDING BUT NOT LIMITED TO THE WARRANTIES OF MERCHANTABILITY, FITNESS FOR A PARTICULAR PURPOSE AND NONINFRINGEMENT. IN NO EVENT SHALL THE AUTHORS OR COPYRIGHT HOLDERS BE LIABLE FOR ANY CLAIM, DAMAGES OR OTHER LIABILITY, WHETHER IN AN ACTION OF CONTRACT, TORT OR OTHERWISE, ARISING FROM, OUT OF OR IN CONNECTION WITH THE SOFTWARE OR THE USE OR OTHER DEALINGS IN THE SOFTWARE.

Package: Nanopb

Copyright © 2011 Petteri Aimonen <jpa at nanopb.mail.kapsi.fi>.

The Nanopb package is subject to the license terms reprinted below:

Zlib License

© 2011 Petteri Aimonen <jpa at nanopb.mail.kapsi.fi>

This software is provided 'as-is', without any express or implied warranty. In no event will the authors be held liable for any damages arising from the use of this software.

Permission is granted to anyone to use this software for any purpose, including commercial applications, and to alter it and redistribute it freely, subject to the following restrictions:

1. The origin of this software must not be misrepresented; you must not claim that you wrote the original software. If you use this software in a product, an acknowledgment in the product documentation would be appreciated but is not required.
2. Altered source versions must be plainly marked as such, and must not be misrepresented as being the original software.
3. This notice may not be removed or altered from any source distribution.

Package: Mbed TLS 2.16.1

© ARM Limited. All rights reserved.

The Mbed TLS package is subject to the license terms reprinted below:

Apache License

Version 2.0, January 2004

<http://www.apache.org/licenses/>

TERMS AND CONDITIONS FOR USE, REPRODUCTION, AND DISTRIBUTION

1. Definitions.

"License" shall mean the terms and conditions for use, reproduction, and distribution as defined by Sections 1 through 9 of this document.

“Licensor” shall mean the copyright owner or entity authorized by the copyright owner that is granting the License.

“Legal Entity” shall mean the union of the acting entity and all other entities that control, are controlled by, or are under common control with that entity. For the purposes of this definition, “control” means (i) the power, direct or indirect, to cause the direction or management of such entity, whether by contract or otherwise, or (ii) ownership of fifty percent (50%) or more of the outstanding shares, or (iii) beneficial ownership of such entity.

“You” (or “Your”) shall mean an individual or Legal Entity exercising permissions granted by this License.

“Source” form shall mean the preferred form for making modifications, including but not limited to software source code, documentation source, and configuration files.

“Object” form shall mean any form resulting from mechanical transformation or translation of a Source form, including but not limited to compiled object code, generated documentation, and conversions to other media types.

“Work” shall mean the work of authorship, whether in Source or Object form, made available under the License, as indicated by a copyright notice that is included in or attached to the work (an example is provided in the Appendix below).

“Derivative Works” shall mean any work, whether in Source or Object form, that is based on (or derived from) the Work and for which the editorial revisions, annotations, elaborations, or other modifications represent, as a whole, an original work of authorship. For the purposes of this License, Derivative Works shall not include works that remain separable from, or merely link (or bind by name) to the interfaces of, the Work and Derivative Works thereof.

“Contribution” shall mean any work of authorship, including the original version of the Work and any modifications or additions to that Work or Derivative Works thereof, that is intentionally submitted to Licensor for inclusion in the Work by the copyright owner or by an individual or Legal Entity authorized to submit on behalf of the copyright owner. For the purposes of this definition, “submitted” means any form of electronic, verbal, or written communication sent to the Licensor or its representatives, including but not limited to communication on electronic mailing lists, source code control systems, and issue tracking systems that are managed by, or on behalf of, the Licensor for the purpose of discussing and improving the Work, but excluding communication that is conspicuously marked or otherwise designated in writing by the copyright owner as “Not a Contribution.”

“Contributor” shall mean Licensor and any individual or Legal Entity on behalf of whom a Contribution has been received by Licensor and subsequently incorporated within the Work.

2. Grant of Copyright License. Subject to the terms and conditions of this License, each Contributor hereby grants to You a perpetual, worldwide, non-exclusive, no-charge, royalty-free, irrevocable copyright license to reproduce, prepare Derivative Works of, publicly display, publicly perform, sublicense, and distribute the Work and such Derivative Works in Source or Object form.
3. Grant of Patent License. Subject to the terms and conditions of this License, each Contributor hereby grants to You a perpetual, worldwide, non-exclusive, no-charge, royalty-free, irrevocable (except as stated in this section) patent license to make, have made, use, offer to sell, sell, import, and otherwise transfer the Work, where such license applies only to those patent claims licensable by such Contributor that are necessarily infringed by their Contribution(s) alone or by combination of their Contribution(s) with the Work to which such Contribution(s) was submitted. If You institute patent litigation against any entity (including a cross-claim or counterclaim in a lawsuit) alleging that the Work or a Contribution incorporated within the Work constitutes direct or contributory patent infringement, then any patent licenses granted to You under this License for that Work shall terminate as of the date such litigation is filed.
4. Redistribution. You may reproduce and distribute copies of the Work or Derivative Works thereof in any medium, with or without modifications, and in Source or Object form, provided that You meet the following conditions:
 - a. You must give any other recipients of the Work or Derivative Works a copy of this License; and
 - b. You must cause any modified files to carry prominent notices stating that You changed the files; and
 - c. You must retain, in the Source form of any Derivative Works that You distribute, all copyright, patent, trademark, and attribution notices from the Source form of the Work, excluding those notices that do not pertain to any part of the Derivative Works; and

d. If the Work includes a “NOTICE” text file as part of its distribution, then any Derivative Works that You distribute must include a readable copy of the attribution notices contained within such NOTICE file, excluding those notices that do not pertain to any part of the Derivative Works, in at least one of the following places: within a NOTICE text file distributed as part of the Derivative Works; within the Source form or documentation, if provided along with the Derivative Works; or, within a display generated by the Derivative Works, if and wherever such third-party notices normally appear. The contents of the NOTICE file are for informational purposes only and do not modify the License. You may add Your own attribution notices within Derivative Works that You distribute, alongside or as an addendum to the NOTICE text from the Work, provided that such additional attribution notices cannot be construed as modifying the License.

You may add Your own copyright statement to Your modifications and may provide additional or different license terms and conditions for use, reproduction, or distribution of Your modifications, or for any such Derivative Works as a whole, provided Your use, reproduction, and distribution of the Work otherwise complies with the conditions stated in this License.

5. Submission of Contributions. Unless You explicitly state otherwise, any Contribution intentionally submitted for inclusion in the Work by You to the Licensor shall be under the terms and conditions of this License, without any additional terms or conditions. Notwithstanding the above, nothing herein shall supersede or modify the terms of any separate license agreement you may have executed with Licensor regarding such Contributions.
6. Trademarks. This License does not grant permission to use the trade names, trademarks, service marks, or product names of the Licensor, except as required for reasonable and customary use in describing the origin of the Work and reproducing the content of the NOTICE file.
7. Disclaimer of Warranty. Unless required by applicable law or agreed to in writing, Licensor provides the Work (and each Contributor provides its Contributions) on an “AS IS” BASIS, WITHOUT WARRANTIES OR CONDITIONS OF ANY KIND, either express or implied, including, without limitation, any warranties or conditions of TITLE, NON-INFRINGEMENT, MERCHANTABILITY, or FITNESS FOR A PARTICULAR PURPOSE. You are solely responsible for determining the appropriateness of using or redistributing the Work and assume any risks associated with Your exercise of permissions under this License.
8. Limitation of Liability. In no event and under no legal theory, whether in tort (including negligence), contract, or otherwise, unless required by applicable law (such as deliberate and grossly negligent acts) or agreed to in writing, shall any Contributor be liable to You for damages, including any direct, indirect, special, incidental, or consequential damages of any character arising as a result of this License or out of the use or inability to use the Work (including but not limited to damages for loss of goodwill, work stoppage, computer failure or malfunction, or any and all other commercial damages or losses), even if such Contributor has been advised of the possibility of such damages.
9. Accepting Warranty or Additional Liability. While redistributing the Work or Derivative Works thereof, You may choose to offer, and charge a fee for, acceptance of support, warranty, indemnity, or other liability obligations and/or rights consistent with this License. However, in accepting such obligations, You may act only on Your own behalf and on Your sole responsibility, not on behalf of any other Contributor, and only if You agree to indemnify, defend, and hold each Contributor harmless for any liability incurred by, or claims asserted against, such Contributor by reason of your accepting any such warranty or additional liability.

END OF TERMS AND CONDITIONS

©2022 Bose Corporation

Licensed under the Apache License, Version 2.0 (the “License”); you may not use this file except in compliance with the License.

You may obtain a copy of the License at: <http://www.apache.org/licenses/LICENSE-2.0>

Unless required by applicable law or agreed to in writing, software distributed under the License is distributed on an “AS IS” BASIS, WITHOUT WARRANTIES OR CONDITIONS OF ANY KIND, either express or implied.

See the License for the specific language governing permissions and limitations under the License.

内容物の確認

内容物	13
-----------	----

BOSE MUSICアプリ

Bose Musicアプリをダウンロードする	14
ヘッドホンを既存のアカウントに追加する	14

ヘッドホンの操作

電源オン	16
スタンバイタイマー	16
電源オフ	17
ヘッドホンの機能	18
メディアの再生と音量調節	18
通話	19
アクションボタン	20

ノイズキャンセリング

ノイズキャンセリングモード	21
ノイズキャンセリング機能のモード変更	21

音声コントロール

音声コントロール機能へのアクセス	22
------------------------	----

BLUETOOTH® 接続

モバイル機器のBluetoothメニューを使用して接続する	23
モバイル機器の接続を解除する	25
モバイル機器を再接続する	25
別のモバイル機器を接続する	25
接続されているモバイル機器を識別する	25
接続されている2台のモバイル機器を切り替える	25
前に接続していたモバイル機器を再接続する	26
ヘッドホンのデバイスリストを消去する	26

ケーブル接続

オーディオケーブルを接続する	27
----------------------	----

バッテリー

ヘッドホンの充電.....	28
充電時間.....	28
バッテリー残量の確認.....	28

ヘッドホンの状態

Bluetooth接続の状態	29
バッテリーの状態	29
充電状態	30
アップデートとエラーの状態	30

BOSE製品への接続

Bose Smart SpeakerまたはBose Smart Soundbarに接続する.....	31
特長.....	31
対応製品.....	31
Bose Musicアプリを使用して接続する.....	31
Bose Smart SpeakerまたはSoundbarに再接続する	32

補足事項

ヘッドホンを収納する.....	33
ヘッドホンのお手入れ.....	34
交換部品とアクセサリ	34
保証	34
シリアル番号.....	35

トラブルシューティング

最初にお試しいただくこと	36
その他の対処方法.....	36
ヘッドホンを工場出荷時の設定に戻す	39

内容物

下図の内容物がすべて同梱されていることを確認してください。



Bose QuietComfort 45 headphones

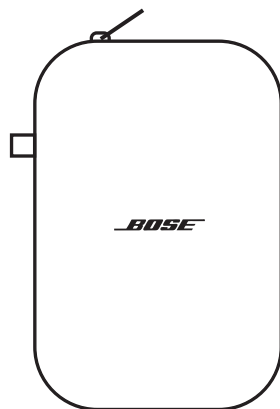

ソフトキャリーケース



USB Type-C®ケーブル

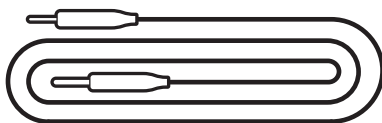

3.5mm - 2.5mm オーディオケーブル

注: 万が一、開梱時に内容物の損傷や欠品などが発見された場合は、そのままでの使用はなさらずに、ただちにお買い上げになった販売店までご連絡ください。

次のサイトをご参照ください: support.Bose.com/QCSE

Bose Musicアプリを使用すると、スマートフォンやタブレットなどのモバイル機器からヘッドホンのセットアップや操作を行うことができます。

このアプリを使用して、Bluetooth接続の管理、ヘッドホンの設定の管理、音声ガイドの言語の選択、アップデートによる新機能の適用を行うことができます。

注: 別のボーズ製品用のBose Musicアカウントを既に作成してある場合は、既存のアカウントにヘッドホンを追加します(14ページの下部を参照)。

BOSE MUSICアプリをダウンロードする

1. モバイル機器でBose Musicアプリをダウンロードします。

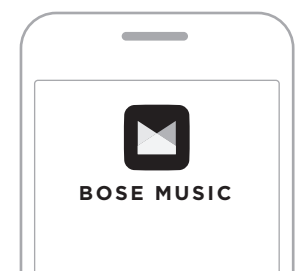

2. アプリの手順に従ってください。

ヘッドホンを既存のアカウントに追加する

Bose QuietComfort 45 headphonesを追加するには、Bose Musicアプリを開いてヘッドホンを追加します。



電源オン

右イヤークップにある電源/*Bluetooth*スイッチを右にスライドします。

バッテリー残量を知らせる音声ガイドが聞こえ、現在の充電状態に応じてステータスインジケータが点灯します(29ページを参照)。



スタンバイタイマー

ヘッドホンが使用されない状態が続くとスタンバイタイマーが働き、バッテリーの消耗を抑えます。

スタンバイタイマーの設定とカスタマイズは、Bose Music アプリで行います。

電源オフ

電源/Bluetoothスイッチを左にスライドします。



注: ヘッドホンの電源をオフにすると、ノイズキャンセリング機能もオフになります。

ヘッドホンの機能

ヘッドホンの操作部は右イヤークップの後ろ側にあります。

メディアの再生と音量調節

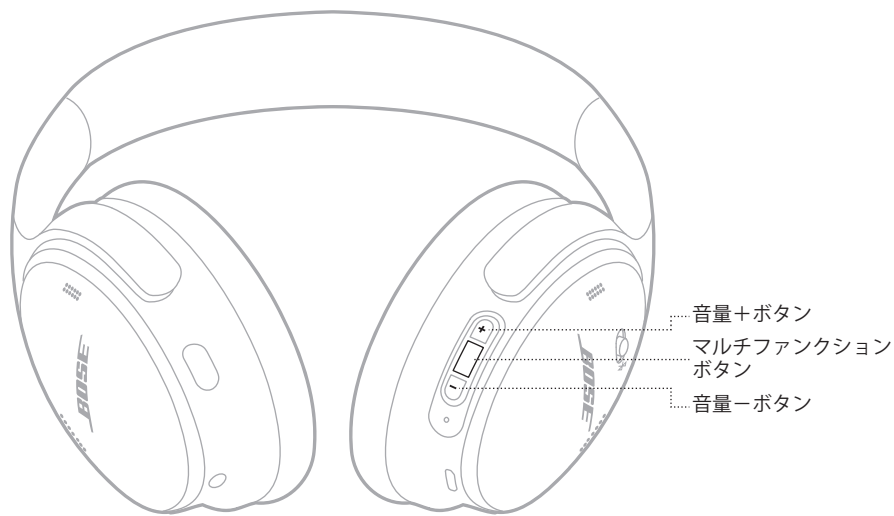

機能	操作方法
再生/一時停止	マルチファンクションボタンを押します。
トラック送り	マルチファンクションボタンを続けて2回押します。
トラック戻し	マルチファンクションボタンを続けて3回押します。
音量を上げる	+ ボタンを押します。
音量を下げる	- ボタンを押します。

注記:

- 音量をすばやく上げるには、+ ボタンを長押しします。
- 音量をすばやく下げるには、- ボタンを長押しします。

通話

マルチファンクションボタンは右イヤークップの後ろ側にあります。マイクは右イヤークップの前側付近にあります。

アクションボタンは左イヤークップの後ろ側にあります。

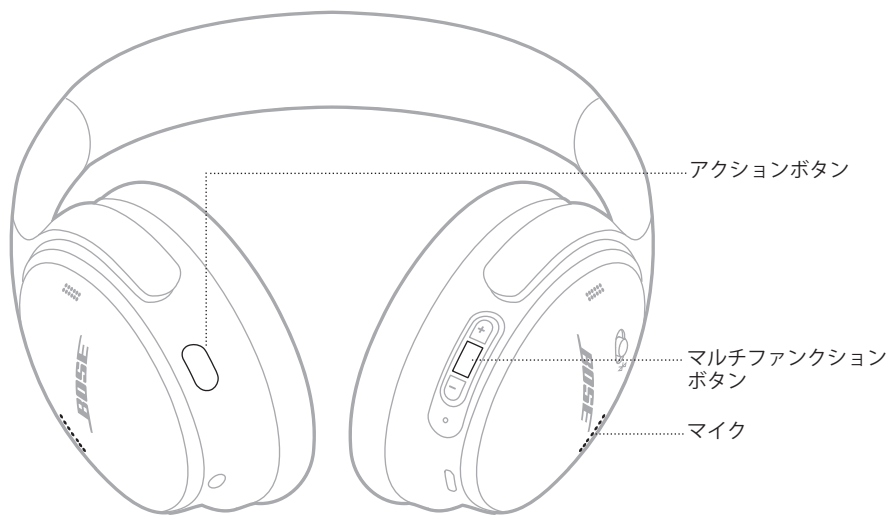

機能	操作方法
着信に応答する/終話する	マルチファンクションボタンを押します。
着信を拒否する	マルチファンクションボタンを1秒間長押しします。
通話中の相手を保留にして割込み着信に応答する	通話中に割込み着信があったら、マルチファンクションボタンを押します。
割込み着信を拒否して、現在の通話を続ける	通話中に割込み着信があったら、マルチファンクションボタンを1秒間長押しします。
2つの通話を切り替える	2つの通話がアクティブな状態で、マルチファンクションボタンを続けて2回押します。
カンファレンスコール	2つの通話がアクティブな状態で、マルチファンクションボタンを3秒間長押しします。
通話をミュート/ミュート解除する	通話中にアクションボタンを続けて2回押します。

アクションボタン

アクションボタンを使用して、ノイズキャンセリングモードをすばやく簡単に切り替えることができます。

アクションボタンは左イヤークップの後ろ側にあります。

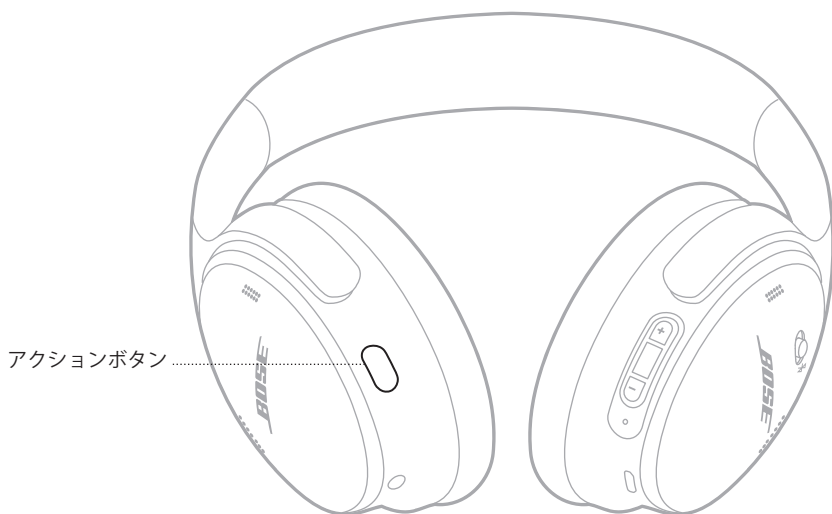

クワイエットモードとアウェアモードを切り替えるには、アクションボタンを押します。

ノイズキャンセリングモードについては、21ページをご覧ください。

ノイズキャンセリングで周囲の不要なノイズを抑制することにより、よりクリアで臨場感のあるサウンドを再生できます。2つのノイズキャンセリングモード(クワイエットとアウェア)のどちらかを選択できます。

クワイエットモードでは、最高レベルのノイズキャンセリング機能により、不快なノイズを遮断できます。

アウェアモードではノイズキャンセリングが最も弱い状態になり、音楽を楽しみながら周囲の音を聞くことができます。

音の好みと環境に合わせてノイズキャンセリングモードを選択してください。

ノイズキャンセリングモード

モード	説明
クワイエット	最高クラスのノイズキャンセリングレベルでBoseサウンドを楽しめます。
アウェア	音楽を楽しみながら周囲の音を聞くことができます。

注: ヘッドホンの電源をオンにすると、最後に使用したモードになります。

ノイズキャンセリング機能のモード変更

ノイズキャンセリングモードを変更するには、アクションボタンを押します。

選択したノイズキャンセリングモードを知らせる音声ガイドが流れます。

ヒント: ノイズキャンセリングモードは、Bose Musicアプリを使用して変更することもできます。

音声コントロール機能へのアクセス

ヘッドホンを使用して、モバイル機器の音声コントロールにアクセスできます。音声コントロールにアクセスするには、マルチファンクションボタンを1秒間長押しします。

マルチファンクションボタンは右イヤークップの後ろ側にあります。

注: 通話中は音声コントロール機能を使用できません。

モバイル機器のBLUETOOTHメニューを使用して接続する

ヘッドホンのデバイスリストには、機器を最大8台まで登録でき、同時に2台まで接続できます。ただし、一度に音楽を再生できる機器は1台だけです。

注: 最も良い方法は、Bose Musicアプリを使用してモバイル機器を設定し、接続することです(14ページを参照)。

1. 電源/Bluetoothスイッチを右の✱マークの方へ3秒間スライドしたままにします。

「接続準備完了」という音声が聞こえ、ステータスインジケーターが青く点滅します。



- お使いの機器のBluetooth機能をオンにします。

注: 通常、Bluetooth機能は設定メニューにあります。

- デバイスリストから本製品を選択します。

ヒント: Bose Musicアプリでヘッドホンに付けた名前を探してください。ヘッドホンに名前を付けていない場合は、デフォルトの名前が表示されます。



接続すると、「<機器名>に接続済みです」という音声ガイドが聞こえ、ステータスインジケータが10秒間青く点灯します。

モバイル機器の接続を解除する

モバイル機器の接続を解除するには、Bose Music アプリを使用します。

ヒント: Bluetooth 設定を使用して機器の接続を解除することもできます。
Bluetooth 機能を無効にすると、他の機器との接続もすべて解除されます。

モバイル機器を再接続する

本製品は電源をオンにすると、直近に接続していた2台の機器に再接続します。

注記:

- モバイル機器が通信範囲内(9m)にあり、電源が入っている必要があります。
- モバイル機器の Bluetooth 機能が有効であることを確認します。

別のモバイル機器を接続する

別の機器を接続するには、Bose Music アプリをダウンロード(14ページを参照)するか、モバイル機器の Bluetooth メニューを使用します(23ページを参照)。

注: ただし、一度に音楽を再生できる機器は1台だけです。

接続されているモバイル機器を識別する

電源/Bluetooth スイッチを右の ✱ マークの方へスライドして放すと、現在接続されている機器の名前が聞こえます。

接続されている2台のモバイル機器を切り替える

1. 1台目のモバイル機器の再生を停止します。
2. 2台目のモバイル機器で音楽を再生します。

注: 電話がかかってきたら、どちらのモバイル機器で音楽を再生しているかに関係なく、どちらからの着信でも受けることができます。

前に接続していたモバイル機器を再接続する

1. 電源/*Bluetooth*スイッチを右の✳マークの方へスライドして放すと、接続されている機器の名前が聞こえます。
2. 2秒以内にもう一度電源/*Bluetooth*ボタンを右の✳マークの方へスライドして放すと、ヘッドホンのデバイスリストにある次の機器に接続します。
3. 使用する機器の名前が聞こえるまで、手順を繰り返します。
機器が接続されるとピープ音が聞こえます。
4. 接続されたモバイル機器で音楽を再生します。

注: 既に2台の機器がヘッドホンに接続されている場合、新しい機器が以前に接続されていた2台目の機器に代わって接続されます。

ヘッドホンのデバイスリストを消去する

1. 「*Bluetooth* デバイスリストを消去しました。接続準備完了」と聞こえるまで15秒間、電源/*Bluetooth*スイッチを右の✳マークの方へスライドしたままにします。
2. モバイル機器の*Bluetooth* リストからお使いのヘッドホンを削除します。
すべての機器が消去され、ヘッドホンが新しい機器と接続可能な状態になります。

オーディオケーブルを接続する

Bluetooth非対応の機器に接続する場合や、バッテリーが切れている場合は、付属の3.5mm - 2.5mmケーブルを使用します。

1. ケーブルを左イヤークップの2.5 mm端子に接続します。



2. ケーブルの反対側をオーディオ機器の3.5 mm端子に接続します。

注: 音声ケーブルが接続されている場合は、ヘッドホンの電源をオンまたはオフにして使用することができます。

ヘッドホンの充電

1. USBケーブルの小さい方のプラグを右イヤークップのUSB-C端子に接続します。
2. 充電ケーブルのもう一方の端をUSBウォールチャージャーに接続します。



注記:

- ヘッドホンの充電が始まると、ステータスインジケータが10秒間白く点滅します。充電が完了すると、ステータスインジケータは白く点灯します。
- 充電中はヘッドホンで音楽を聴くことはできません。

充電時間

ヘッドホンを完全に充電するには最長2.5時間かかります。

バッテリー残量の確認

ヘッドホンの電源をオンにするたびに、バッテリー残量を知らせる音声ガイドが流れます。ヘッドホンのバッテリー残量が低下すると、「バッテリー残量が低下しています。すぐに充電してください」と聞こえます。

注: バッテリー残量を目で確認するには、右イヤークップにあるステータスインジケータをご覧ください。詳しくは、「バッテリーの状態」(29ページ)をご覧ください。

ステータスインジケータは右イヤークップにあります。



BLUETOOTH接続の状態

Bluetooth接続の状態を示します。

インジケータの表示	システムの状態
青の点滅	接続準備完了
青の点灯(10秒間)	接続済み

バッテリーの状態

バッテリー残量を示します。

インジケータの状態	システムの状態
白の点灯	十分に充電されている
オレンジの点灯	バッテリー残量低下

ヒント: Bose Musicアプリを使用してバッテリー残量を確認することもできます。

充電状態

充電状態を示します。

インジケータの状態	システムの状態
白の2回点滅	充電開始
オレンジの点灯	充電中
白の点灯	満充電

アップデートとエラーの状態

アップデートまたはエラーの状態を示します。

インジケータの状態	システムの状態
白の速い点滅(10秒間)	ソフトウェアアップデート中(USB経由)
白の遅い点滅(30～60秒間)	ソフトウェアアップデート中(無線経由)
オレンジと白の点滅	エラー、Boseカスタマーサービスに連絡してください

BOSE SMART SPEAKERまたはBOSE SMART SOUNDBARに接続する

SimpleSync™テクノロジーにより、Bose Smart SoundbarやBose Smart Speakerにヘッドホンを接続して、自分だけのリスニングを楽しむことができます。

特長

- 製品ごとの音量を個別に調節できるので、ヘッドホンの音量はそのままにして、Bose Smart Soundbarの音量を下げたりミュートしたりできます。
- ヘッドホンをBose Smart Speakerに接続して、隣の部屋で音楽をクリアな音で楽しむことができます。

注: SimpleSync™テクノロジーは、最大9 mのBluetooth通信範囲内で機能します。壁や建材の種類によって受信状態が変わる場合があります。

対応製品

ヘッドホンとBose Smart SpeakerまたはBose Smart Soundbarを接続して、音楽を同時に再生することができます。

対応製品の例:

- Bose Smart Soundbar 700/Bose Soundbar 700
- Bose Soundbar 500
- Bose Smart Speaker 500/Bose Home Speaker 500
- Bose Home Speaker 300
- Bose Portable Smart Speaker/Bose Portable Home Speaker

新しい製品も随時追加されます。全製品のリストと詳細については、次のサイトをご覧ください。worldwide.Bose.com/Support/Groups

Bose Musicアプリを使用して接続する

1. ヘッドホンの電源/Bluetoothスイッチを右の✳マークの方へ3秒間スライドしたままにします。

「別のデバイスの接続準備が完了しました」という音声がかえ、ステータスインジケーターが青く点滅します。

2. Bose Musicアプリを使用して、ヘッドホンを対応するBose製品に接続できます。詳しくは、次のサイトをご覧ください: worldwide.Bose.com/Support/Groups

注記:

- ヘッドホンがサウンドバーやスピーカーから9 m以内にあることを確認してください。
- ヘッドホンに一度に接続できる製品は1台だけです。

BOSE SMART SPEAKERまたはSOUNDBARに再接続する

ヘッドホンの電源をオンにします(「電源オン」(16ページ)を参照)。

ヘッドホンは、最後に接続していたBluetooth機器(サウンドバーやスピーカーなど)への接続を試みます。

注記:

- サウンドバーやスピーカーが通信範囲内(9 m)にあり、電源が入っている必要があります。
- ヘッドホンを再接続できない場合は、「以前に接続されていたBose Smart SoundbarやBose Smart Speakerとヘッドホンを再接続できない」(38ページ)をご覧ください。

ヘッドホンを収納する

持ち運びに便利のようにイヤークップを回転して収納することができます。ヘッドホンをケースに収納します。

1. 両方のイヤークップを平らになるように回します。



2. 左のイヤークップをヘッドバンドに向けて折りたたみます。

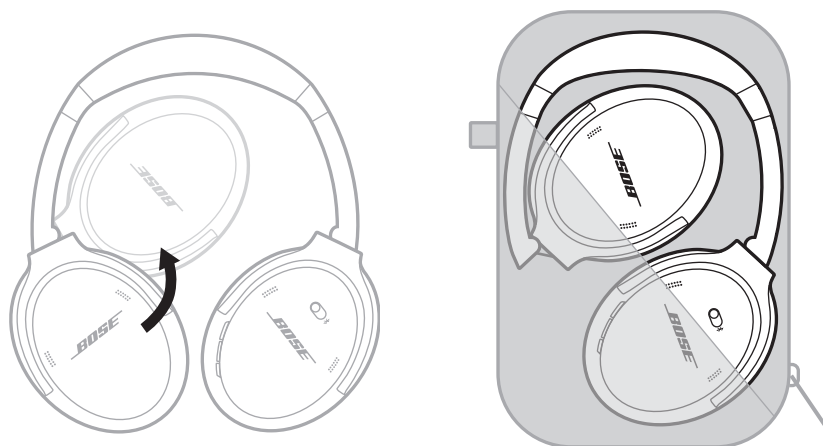

注記:

- 本製品を使用しない時は、ヘッドホンの電源をオフにしてください。
- 本製品を数か月以上使用しない場合は、バッテリーを完全に充電してから保管してください。

ヘッドホンのお手入れ

乾いた柔らかい布で、外面を拭きます。

イヤークップの中が濡れないように注意してください。

交換部品とアクセサリ

交換部品とアクセサリは、ボーズ製品取扱店、弊社Webサイト、またはお電話によるご注文でご購入いただけます。次のサイトをご参照ください：
support.Bose.com/QCSE

保証

製品保証の詳細は worldwide.Bose.com/Warranty をご覧ください。

製品の登録をお願いいたします。登録は弊社Webサイト (worldwide.Bose.com/ProductRegistration) から簡単に行えます。製品を登録されない場合でも、保証の内容に変更はありません。

シリアル番号

シリアル番号は右イヤークップ内側のスクリーンの下に記載されています。スクリーンは、イヤークップ内部の部品を保護するために、イヤークップの内側に貼られています。

シリアル番号を確認するには、スクリーンの端をつまんで静かに剥がします。

注意: ヘッドホンが破損する恐れがありますので、スクリーンを押し込んだり、イヤークップ内部のほかの部品を外したりしないでください。

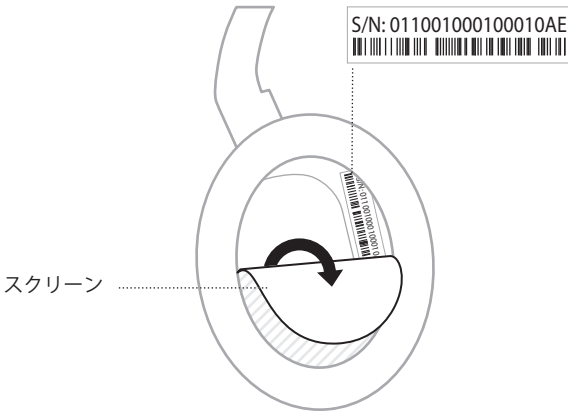

最初にお試しいただくこと

ヘッドホンに問題が生じた場合は、下記の点をご確認ください。

- ステータスインジケータの状態を確認します(29ページを参照)。
- バッテリーを充電します(28ページを参照)。
- ヘッドホン、モバイル機器、音楽再生アプリの音量を上げます。
- Bose Musicアプリをダウンロードして、入手可能なソフトウェアのアップデートを実行します(14ページを参照)。
- 別のモバイル機器を接続してみます(25ページを参照)。

問題が解決しない場合は、次の表を参照して一般的な問題の症状と対処方法をご確認ください。それでも問題が解決できない場合は、Boseカスタマーサービスまでお問い合わせください。

次のサイトをご参照ください: worldwide.Bose.com/contact

その他の対処方法

症状	対処方法
ヘッドホンの電源が入らない	バッテリーを充電します。
ヘッドホンとモバイル機器を接続できない	<p>音声ケーブルを取り外します。</p> <p>USB充電ケーブルを取り外します。</p> <p>モバイル機器での操作:</p> <p><i>Bluetooth</i>機能をオフにしてから、もう一度オンにします。</p> <p>モバイル機器の<i>Bluetooth</i>リストからBose QuietComfort 45 headphonesを削除します(Low Energy (LE) ラベルの付いた重複項目も含む)。もう一度接続し直します。</p> <p>モバイル機器をヘッドホンに近づけ、他の干渉源や障害物から離します。</p> <p>support.Bose.com/QCSEにアクセスして、解説ビデオを参照します。</p> <p>接続済みのデバイスリストを消去して(26ページを参照)、もう一度接続し直します。</p>
バッテリーが充電されない	<p>充電用USBケーブルの両端をしっかりと接続し直します。</p> <p>別の電源アダプターで試してみます。</p> <p>ヘッドホンが非常に高温または低温の場所に置かれていた場合は、室温に戻してからもう一度充電してください。</p>

症状	対処方法
音が出ない	<p>ヘッドホンの電源がオンになっている、バッテリーが充電されていることを確認してください。</p> <p>ステータスインジケータの状態を確認します(29ページを参照)。</p> <p>電源/Bluetoothスイッチを右にスライドして放し、接続している機器を確認します。正しい機器が接続されていることを確認してください。</p> <p>モバイル機器をヘッドホンに近づけ、他の干渉源や障害物から離します。</p> <p>別の楽曲や音楽再生アプリを使用します。</p> <p>モバイル機器が2台接続されている場合は、最初に他の機器で再生を一時停止します。</p> <p>モバイル機器が2台接続されている場合は、両方の機器をヘッドホンの通信範囲内(9m)に移動してください。</p> <p>モバイル機器に保存されている音楽やビデオのファイルで試してみてください。</p>
音質が悪い	<p>別の楽曲や音楽再生アプリを使用します。</p> <p>別のモバイル機器を接続します(25ページを参照)。</p> <p>2台目の機器の接続を解除してください。</p> <p>モバイル機器をヘッドホンに近づけ、他の干渉源や障害物から離します。</p> <p>モバイル機器に保存されている音楽やビデオのファイルで試してみてください。</p>
音声ケーブルで接続した機器からの音が聞こえない	<p>音声ケーブルの両端をしっかりと接続し直します。</p> <p>ヘッドホン、モバイル機器、音楽再生アプリの音量を上げます。</p> <p>別の機器を接続します(25ページを参照)。</p>
音声ケーブルで接続されている機器からの音質が悪い	<p>音声ケーブルの両端をしっかりと接続し直します。</p> <p>別の機器を接続します(25ページを参照)。</p>
アクションボタンを使用して、ノイズキャンセリングモードを変更できない	<p>ヘッドホンの電源がオンになっていることを確認します。</p> <p>Bose Musicアプリを使用して、ノイズキャンセリングモードを変更します。</p>

症状	対処方法
<p>ヘッドホンを Bose Smart Soundbar または Bose Smart Speaker に接続できない</p>	<p>「別のデバイスの接続準備が完了しました」と聞こえるか、Bluetooth インジケーターが青く点滅するまで、電源/Bluetooth ボタンをスライドしたままにします。</p> <p>ヘッドホンがサウンドバーやスピーカーから 9 m 以内にあることを確認してください。</p>
<p>以前に接続されていた Bose Smart Soundbar や Bose Smart Speaker とヘッドホンを再接続できない</p>	<p>前に接続していた機器を再度接続します (26 ページを参照)。</p>
<p>接続した Bose Smart Soundbar または Bose Smart Speaker からの音が遅れて再生される</p>	<p>Bose Music アプリをダウンロードして、入手可能なソフトウェアのアップデートを実行します。</p>

工場出荷時の設定に戻すと、すべての設定が消去され、ヘッドホンが箱から出したときの状態に戻ります。その後、初めてヘッドホンをセットアップするときのように設定することができます。

工場出荷時の設定へのリセットは、ヘッドホンに問題がある場合や、Boseカスタマーサービスから指示された場合にのみ行うようにしてください。

ヘッドホンを工場出荷時の設定に戻す

1. モバイル機器のBluetoothリストからヘッドホンを削除します。
2. Bose Music アプリを使用して、Bose アカウントからヘッドホンを削除します。

注: Bose Music アプリでBose アカウントからヘッドホンを削除する方法の詳細については、次のサイトをご参照ください: support.Bose.com/QCSE

3. 電源/Bluetoothスイッチを右の✳マークの方へスライドしたままにします。同時に、アクションボタンを30秒間長押しします。

ステータスインジケータが白く点滅します。30秒後、ステータスインジケータがオレンジに点滅し(2～3秒間)、工場出荷時の設定に戻していることを示します。

4. 復元が完了すると、ステータスインジケータがゆっくりと青く点滅します。これでヘッドホンは、箱から出したときの状態に戻っています。

يرجى قراءة جميع تعليمات السلامة، والأمان، والاستخدام والاحتفاظ بها.

تعلن شركة Bose Corporation بموجبه أن هذا المنتج يتوافق مع المتطلبات الأساسية لتوجيه الاتحاد الأوروبي رقم 2014/53/EU وشروطه الأخرى ذات الصلة وجميع متطلبات توجيهات الاتحاد الأوروبي الأخرى المعمول بها. ويمكن العثور على إعلان المطابقة الكامل في الموقع التالي: www.Bose.com/compliance



يتوافق هذا المنتج مع جميع لوائح التوافق الكهرومغناطيسي المعمول بها لعام 2016 وجميع لوائح المملكة المتحدة الأخرى المعمول بها. ويمكن العثور على إعلان المطابقة الكامل في الموقع التالي: www.Bose.com/compliance

تعلن شركة Bose Corporation بموجب هذا المستند أن هذا المنتج يتوافق مع المتطلبات الأساسية التي تنص عليها لوائح الأجهزة اللاسلكية لعام 2017 وجميع لوائح المملكة المتحدة الأخرى المعمول بها. ويمكن العثور على إعلان المطابقة الكامل في الموقع التالي: www.Bose.com/compliance

تعليمات مهمة للسلامة

لا تستخدم هذا الجهاز بالقرب من الماء.

لا تستخدم سوى قطعة قماش جافة أثناء التنظيف.

إحالة جميع أعمال الصيانة إلى أفراد صيانة مؤهلين. يجب إجراء الصيانة عند تلف الجهاز بأي شكل من الأشكال، مثل تلف سلك التغذية الكهربائية، أو القابس، أو انسكاب سائل أو سقوط أشياء على الجهاز، أو تعرضه للمطر، أو الرطوبة، أو عدم عمله بصورة طبيعية أو سقوطه.

تحذيرات/تنبيهات

- لا تستخدم سماعات الرأس مع مستوى صوت مرتفع لمدة طويلة.
- لتجنب تلف السمع، استخدم سماعات الرأس مع مستوى صوت مريح ومعتدل.
- اخفض مستوى الصوت في جهازك قبل وضع سماعات الرأس على/في أذنيك ثم ارفع مستوى الصوت تدريجيًا إلى أن تصل إلى مستوى استماع مريح.
- لا تستخدم سماعات الرأس للمكالمات الهاتفية أو لأي غرض آخر أثناء القيادة.
- لا تستخدم سماعات الرأس مع تشغيل خاصية "إلغاء التشويش" في أي وقت إذ قد تشكل عدم القدرة على سماع الأصوات المحيطة خطرًا عليك أو على الآخرين، كما في أثناء ركوب دراجة أو المشي في منطقة مزدحمة أو بالقرب منها أو من موقع بناء أو سكة حديدية وما إلى ذلك، واتبع القوانين المعمول بها المتعلقة باستخدام سماعات الرأس.
- قم بإيقاف تشغيل سماعات الرأس، أو استخدم سماعات الرأس مع إيقاف "إلغاء التشويش" واضبط مستوى الصوت لضمان أنه يمكنك سماع الأصوات المحيطة بما في ذلك التنبيهات وإشارات التحذير.
- كن على بينة من كيفية اختلاف طبيعة الأصوات التي تعتمد عليها كالتذكيرات أو تحذيرات عند استخدام سماعات الرأس، حتى مع تشغيل الوضع "Aware" (الوعي).
- لا تستخدم سماعات الرأس إذا كانت تُصدر أي ضجيج عالٍ غير عادي. وإذا حدث ذلك، فأوقف تشغيل سماعات الرأس واتصل بخدمة عملاء شركة Bose.
- عليك إزالة سماعات الرأس على الفور إذا شعرت بحرارة أو بفقدان الصوت.
- لا تستخدم محولات الهوائيات المحمولة لتوصيل سماعات الرأس بمقابس مقاعد الطائرة، فقد يؤدي ذلك إلى حدوث إصابة جسدية أو تلف في الممتلكات بسبب السخونة الزائدة.
- لا تستخدم سماعات الرأس للتواصل أثناء الطيران.

يحتوي المنتج على أجزاء صغيرة قد تتسبب في التعرض لخطر الاختناق. غير مناسب للأطفال دون 3 سنوات.



يحتوي هذا المنتج على مادة مغناطيسية. استشر طبيبك فيما إذا كان لهذه السماعات تأثيرٌ على أي أجهزة طبية مزروعة لديك أو لا.



- لتقليل مخاطر نشوب حريق أو صدمة كهربائية، لا تعرّض هذا المنتج للمطر أو قطرات السوائل المتساقطة أو المتناثرة أو الرطوبة ولا تضع أوعية ممتلئة بالسائل مثل المزهريات فوق المنتج أو بالقرب منه.
- أبق المنتج بعيداً عن مصادر اللهب والحرارة. لا تضع أيّ مصادر لهب مكشوف (مثل الشموع المشتعلة) فوق المنتج أو بالقرب منه.
- استخدم هذا المنتج فقط مع مصدر طاقة LPS معتمد من قبل المؤسسة يفى بالمتطلبات التنظيمية المحلية (مثل UL و CSA و VDE و CCC).
- لا تُجر أي تبديلات غير مصرّح بها لهذا المنتج.
- إذا حدث تسرب في البطارية، فلا تسمح للسائل بأن يلامس جلدك أو عينيك. وإذا حدث تلامس، فاطلب المشورة الطبية.
- لا تعرّض المنتجات التي تحتوي على بطاريات لحرارة زائدة (مثل تخزينها تحت أشعة الشمس المباشرة، أو تعريضها للنار أو ما شابه ذلك).
- لا ترتد السماعة أثناء شحنها.

ملاحظة: تم اختبار هذا الجهاز وُجد أنه يتوافق مع حدود جهاز رقمي من الفئة B وفقاً للجزء رقم 15 من قواعد لجنة الاتصالات الفيدرالية (FCC). وقد وضعت هذه الحدود لتوفير الحماية المناسبة من التداخل الضار عند تركيب الجهاز في منطقة سكنية. يولد هذا الجهاز طاقة تردد لاسلكية ويستخدمها ويمكن أن يشعها، وإذا لم يتم تركيبه واستخدامه وفقاً للتعليمات، فيمكن أن يتسبب في حدوث تداخل ضار في الاتصالات اللاسلكية. ومع ذلك، فلا يوجد ضمان لعدم حدوث تداخل بسبب التركيب. إذا تسبب هذا الجهاز في حدوث تداخل ضار للاستقبال اللاسلكي أو التلفزيوني (يمكن التحقق من ذلك عن طريق إطفاء الجهاز وإعادة تشغيله)، يُوصى المستخدم بتصحيح التداخل باستخدام إجراء أو أكثر من الإجراءات التالية:

• غير اتجاه منتج الاستقبال أو هوائي الاستقبال أو موضعهما.

• زيادة المسافة بين الجهاز وجهاز الاستقبال.

• توصيل الجهاز بمأخذ كهربائي في دائرة مختلفة عن الدائرة التي تم توصيل جهاز الاستقبال بها.

• استشر الموزع المعتمد أو أحد الفنيين من ذوي الخبرة بأجهزة الراديو أو التلفزيون لطلب المساعدة.

قد يؤدي القيام بأي تغييرات أو تعديلات دون موافقة صريحة من شركة Bose Corporation إلى إلغاء ترخيص المستخدم لتشغيل هذا الجهاز.

يتوافق هذا الجهاز مع الفقرة 15 من قواعد هيئة الاتصالات الفيدرالية، ومعايير المواصفات القياسية اللاسلكية للأجهزة المعفاة من ترخيص وزارة الابتكار والعلوم والتنمية الاقتصادية في كندا. يخضع التشغيل للشروطين التاليين: (1) ألا يتسبب في حدوث تداخل ضار و (2) أن يقبل أي تداخل يتم استقباله، بما في ذلك التداخل الذي قد يتسبب في تشغيله على نحو غير مرغوب فيه.

يتوافق هذا الجهاز مع حدود التعرض البشري للإشعاع التي حددتها هيئة الاتصالات الفيدرالية، ووزارة الابتكار والعلوم والتنمية الاقتصادية في كندا للسكان عامةً. يجب عدم تحديد موضع مشترك لجهاز الإرسال هذا أو تشغيله بالتزامن مع أي هوائي أو جهاز إرسال آخر.

يُلَبّي متطلبات هيئة التطوير الإعلامي للمعلومات والاتصالات (IMDA).

معرف لجنة الاتصالات الفيدرالية (FCC): A94437310

الصناعة الكندية IC: 3232A-437310

CAN ICES-3(B)/NMB-3(B)

بالنسبة لأوروبا:

نطاق تردد العملية التشغيلية من 2400 إلى 2483.5 ميجا هرتز.

الحد الأقصى لنقل الطاقة أقل من 20 ديسيبل ميلي واط من القدرة المشعة المكافئة المتناحية.

الحد الأقصى لطاقة الإرسال أقل من الحدود التنظيمية؛ وهو ما يعني أنّ اختبار معدل الامتصاص النوعي SAR غير ضروري ومستثنى وفقاً للوائح السارية.

هذا الرمز يعني أنه يجب عدم التخلص من النفايات المنزلية، بل يجب تسليمه إلى مرفق جمع نفايات مناسب لإعادة تدويره. يساعد التخلص السليم وإعادة التدوير على حماية الموارد الطبيعية، وصحة الإنسان، والبيئة. لمزيد من المعلومات حول طريقة التخلص من هذا المنتج وإعادة تدويره، يرجى الاتصال بالبيدات المحلية التابعة لك، أو مرفق التخلص من النفايات، أو المتجر الذي اشتريته منه هذا المنتج.

الوائح الفنية للأجهزة ذات الترددات اللاسلكية منخفضة الطاقة

يحظر على أي شركة أو مؤسسة أو مستخدم تغيير ترددات أو تعزيز طاقة الإرسال أو تغيير السمة الأصلية أو الأداء في أي جهاز من الأجهزة المعتمدة ذات الترددات اللاسلكية منخفضة الطاقة؛ وذلك دون الحصول على إذن من اللجنة الوطنية الصينية للاتصالات (NCC). لا تؤثر الأجهزة ذات الترددات اللاسلكية منخفضة الطاقة على أمن الطائرات ولا تتداخل مع الاتصالات القانونية (إن وجدت)، وفي حال حدوث تداخل، يجب على المستخدم إيقاف تشغيلها على الفور إلى أن تتم إزالة هذا التداخل. الاتصالات القانونية المذكورة تعني أن الاتصالات اللاسلكية تعمل وفقاً لقانون إدارة الاتصالات. يجب أن تكون أجهزة تردد الراديو منخفضة الطاقة غرضة للتداخل من قبل الاتصالات القانونية أو الأجهزة المشعة لموجات الراديو ISM.

لا تحاول إخراج بطارية الليثيوم أيون القابلة لإعادة الشحن من هذا المنتج. تواصل مع موزع Bose المحلي لديك أو بقني مؤهل آخر لإخراجها.

يجب عدم إزالة بطارية الليثيوم أيون القابلة للشحن من هذا المنتج إلا بواسطة فنيين مؤهلين فقط. يرجى الاتصال بتاجر تجزئة Bose المحلي لديك أو الإطلاع على products.bose.com/static/compliance/index.html لمزيد من المعلومات.

يُرجى التخلص من البطاريات المستخدمة بطريقة سليمة، بالتابع للوائح المحلية. لا تحرقها.



أسماء المواد أو العناصر السامة أو الخطرة ومحتوياتها						
المواد والعناصر السامة أو الخطرة						
اسم الجزء	الرصاص (Pb)	الزئبق (Hg)	الكاديوم (Cd)	سداسي الكروم (CR(VI))	ثنائي الفينيل متعدد البروم (PBB)	أثير ثنائي الفينيل المعالج بالبروم (PBDE)
مركبات ثنائي الفينيل متعدد الكلور (PCB)	X	O	O	O	O	O
الأجزاء المعدنية	X	O	O	O	O	O
الأجزاء البلاستيكية	O	O	O	O	O	O
السماعة	X	O	O	O	O	O
الكليات	X	O	O	O	O	O
تم إعداد هذا الجدول وفقاً لأحكام المعيار SJ/T 11364.						
O: يشير إلى أن هذه المادة السامة أو الخطرة الموجودة في كل المواد المتجانسة لهذا الجزء أقل من متطلبات تقييد معيار GB/T 26572.						
X: يشير إلى أن هذه المادة السامة أو الخطرة الموجودة على الأقل في إحدى المواد المتجانسة لهذا الجزء أعلى من متطلبات التقييد لمعيار GB/T 26572.						



تاريخ التصنيع: تشير الخانة الثامنة في الرقم المسلسل إلى سنة التصنيع؛ إذ يشير الرقم "2" إلى 2012 أو 2022.

المستورد في الصين: Bose Electronics (Shanghai) Company Limited, Level 6, Tower D, No. 2337 Gudai Rd. Minhang District, Shanghai 201100

المستورد في الاتحاد الأوروبي: Bose Products B.V., Gorslaan 60, 1441 RG Purmerend, The Netherlands

المستورد في المكسيك: Bose de México S. de R.L. de C.V., Avenida Prado Sur #150, Piso 2, Interior 222 y 223, Colonia Lomas de Chapultepec V Sección, Miguel Hidalgo, Ciudad de México, C.P. 11000
+5255 (5202) 3545 رقم الهاتف:

المستورد في تايوان: Bose Limited Taiwan Branch (H.K.), 9F., No. 10, Sec. 3, Minsheng E. Road, Zhongshan Dist. Taipei City 10480
+886-2-2514 7676 رقم هاتف تايوان:

المستورد في المملكة المتحدة: Bose Limited, Bose House, Quayside Chatham Maritime, Chatham, Kent, ME4 4QZ، بالمملكة المتحدة

القدرة المقننة على الإدخال: 5 فولت = 0.5 أمبير

نطاق درجة حرارة الشحن: من 32 إلى 113 درجة فهرنهايت (من 0 إلى 45 درجة مئوية)

نطاق درجة حرارة تفريغ الشحن: من -4 إلى 140 درجة فهرنهايت (من -20 إلى 60 درجة مئوية)

موديل 437310، يوجد معرّف CMIIT داخل قطعة الأذن أسفل السكريم.

يُرجى استكمال سجلاتك والاحتفاظ بها

يوجد الرقم المسلسل ورقم الموديل داخل قطعة الأذن أسفل السكريم.

الرقم المسلسل: _____

رقم الموديل: _____

يرجى الاحتفاظ بإبصال الشراء مع دليل المالك. يمكنك الآن تسجيل منتج Bose الخاص بك. يمكنك القيام بذلك بسهولة من خلال الانتقال إلى worldwide.Bose.com/ProductRegistration

معلومات الأمان

هذا المنتج قادر على استقبال التحديثات الأمنية من Bose تلقائيًا عند الاتصال بتطبيق Bose Music. من أجل استقبال التحديثات الأمنية عبر تطبيق المحمول، يجب عليك إكمال عملية إعداد المنتج في تطبيق Bose Music. وإذا لم تُكْمَل عملية الإعداد، فستتحمل مسؤولية تثبيت التحديثات الأمنية التي توفرها Bose عبر btu.Bose.com



تُعد Apple، وشعار Apple، و iPad، و iPhone، و iPod علامات تجارية تابعة لشركة Apple Inc، ومُسجَلة في الولايات المتحدة الأمريكية ودول أخرى. App Store هي علامة خدمة لشركة Apple، ويتم استخدام العلامة التجارية "iPhone" في اليابان بترخيص من شركة Aiphone K.K.

إن استخدام بطاقة "Made for Apple" يعني أنه قد تم تصميم أحد الملحقات للاتصال بصورة خاصة بمنتج (منتجات) Apple المذكور في البطاقة، وأنه قد تم التصديق عليه من قِبل المُطَوِّر لاستيفائه معايير أداء Apple. تُعد Apple غير مسؤولة عن تشغيل هذا الجهاز أو أمثاله لمعايير السلامة والمعايير التنظيمية.

العلامة التجارية النصية Bluetooth® وشعاراتها هي علامات تجارية مُسجَلة مملوكة لشركة Bluetooth SIG، وأي استخدام لهذه العلامات من قِبل شركة Bose يكون بموجب ترخيص.

إن Google Play هي علامة تجارية لشركة Google LLC.

USB Type-C® و USB-C® هما علامتان تجاريتان مسجلتان لدى USB Implementers Forum.

يعد كل من Bose، و Bose Home Speaker، و Bose Music، و شعار Bose Music، و Bose Smart Speaker، و Bose Smart Speaker، و Bose Smart Soundbar، و Bose Soundbar، و QuietComfort، و SimpleSync علامات تجارية لشركة Bose.

المقر الرئيسي لشركة Bose: 1-877-230-5639

حقوق الطبع والنشر © لعام 2022 محفوظة لشركة Bose. لا يجوز نسخ أي جزء من هذا الدليل، أو تعديله، أو توزيعه، أو استخدامه بطريقة أخرى دون إذن كتابي مسبق.

The following license disclosures apply to certain third-party software packages used as components in the product.

Package: FreeRTOS

Copyright © Amazon Web Services, Inc. or its affiliates. All rights reserved.

The FreeRTOS package is subject to the license terms reprinted below:

MIT License

Permission is hereby granted, free of charge, to any person obtaining a copy of this software and associated documentation files (the "Software"), to deal in the Software without restriction, including without limitation the rights to use, copy, modify, merge, publish, distribute, sublicense, and/or sell copies of the Software, and to permit persons to whom the Software is furnished to do so, subject to the following conditions:

The above copyright notice and this permission notice shall be included in all copies or substantial portions of the Software.

THE SOFTWARE IS PROVIDED "AS IS", WITHOUT WARRANTY OF ANY KIND, EXPRESS OR IMPLIED, INCLUDING BUT NOT LIMITED TO THE WARRANTIES OF MERCHANTABILITY, FITNESS FOR A PARTICULAR PURPOSE AND NONINFRINGEMENT. IN NO EVENT SHALL THE AUTHORS OR COPYRIGHT HOLDERS BE LIABLE FOR ANY CLAIM, DAMAGES OR OTHER LIABILITY, WHETHER IN AN ACTION OF CONTRACT, TORT OR OTHERWISE, ARISING FROM, OUT OF OR IN CONNECTION WITH THE SOFTWARE OR THE USE OR OTHER DEALINGS IN THE SOFTWARE.

Package: Nanopb

Copyright © 2011 Petteri Aimonen <jpa at nanopb.mail.kapsi.fi>.

The Nanopb package is subject to the license terms reprinted below:

Zlib License

© 2011 Petteri Aimonen <jpa at nanopb.mail.kapsi.fi>

This software is provided 'as-is', without any express or implied warranty. In no event will the authors be held liable for any damages arising from the use of this software.

Permission is granted to anyone to use this software for any purpose, including commercial applications, and to alter it and redistribute it freely, subject to the following restrictions:

1. The origin of this software must not be misrepresented; you must not claim that you wrote the original software. If you use this software in a product, an acknowledgment in the product documentation would be appreciated but is not required.
2. Altered source versions must be plainly marked as such, and must not be misrepresented as being the original software.
3. This notice may not be removed or altered from any source distribution.

Package: Mbed TLS 2.16.1

© ARM Limited. All rights reserved.

The Mbed TLS package is subject to the license terms reprinted below:

Apache License

Version 2.0, January 2004

<http://www.apache.org/licenses/>

TERMS AND CONDITIONS FOR USE, REPRODUCTION, AND DISTRIBUTION

1. Definitions.

"License" shall mean the terms and conditions for use, reproduction, and distribution as defined by Sections 1 through 9 of this document.

"Licensor" shall mean the copyright owner or entity authorized by the copyright owner that is granting the License.

"Legal Entity" shall mean the union of the acting entity and all other entities that control, are controlled by, or are under common control with that entity. For the purposes of this definition, "control" means (i) the power, direct or indirect, to cause the direction or management of such entity, whether by contract or otherwise, or (ii) ownership of fifty percent (50%) or more of the outstanding shares, or (iii) beneficial ownership of such entity.

"You" (or "Your") shall mean an individual or Legal Entity exercising permissions granted by this License.

"Source" form shall mean the preferred form for making modifications, including but not limited to software source code, documentation source, and configuration files.

"Object" form shall mean any form resulting from mechanical transformation or translation of a Source form, including but not limited to compiled object code, generated documentation, and conversions to other media types.

"Work" shall mean the work of authorship, whether in Source or Object form, made available under the License, as indicated by a copyright notice that is included in or attached to the work (an example is provided in the Appendix below).

"Derivative Works" shall mean any work, whether in Source or Object form, that is based on (or derived from) the Work and for which the editorial revisions, annotations, elaborations, or other modifications represent, as a whole, an original work of authorship. For the purposes of this License, Derivative Works shall not include works that remain separable from, or merely link (or bind by name) to the interfaces of, the Work and Derivative Works thereof.

"Contribution" shall mean any work of authorship, including the original version of the Work and any modifications or additions to that Work or Derivative Works thereof, that is intentionally submitted to Licensor for inclusion in the Work by the copyright owner or by an individual or Legal Entity authorized to submit on behalf of the copyright owner. For the purposes of this definition, "submitted" means any form of electronic, verbal, or written communication sent to the Licensor or its representatives, including but not limited to communication on electronic mailing lists, source code control systems, and issue tracking systems that are managed by, or on behalf of, the Licensor for the purpose of discussing and improving the Work, but excluding communication that is conspicuously marked or otherwise designated in writing by the copyright owner as "Not a Contribution."

"Contributor" shall mean Licensor and any individual or Legal Entity on behalf of whom a Contribution has been received by Licensor and subsequently incorporated within the Work.

2. Grant of Copyright License. Subject to the terms and conditions of this License, each Contributor hereby grants to You a perpetual, worldwide, non-exclusive, non-charge, royalty-free, irrevocable copyright license to reproduce, prepare Derivative Works of, publicly display, publicly perform, sublicense, and distribute the Work and such Derivative Works in Source or Object form.
3. Grant of Patent License. Subject to the terms and conditions of this License, each Contributor hereby grants to You a perpetual, worldwide, non-exclusive, non-charge, royalty-free, irrevocable (except as stated in this section) patent license to make, have made, use, offer to sell, sell, import, and otherwise transfer the Work, where such license applies only to those patent claims licensable by such Contributor that are necessarily infringed by their Contribution(s) alone or by combination of their Contribution(s) with the Work to which such Contribution(s) was submitted. If You institute patent litigation against any entity (including a cross-claim or counterclaim in a lawsuit) alleging that the Work or a Contribution incorporated within the Work constitutes direct or contributory patent infringement, then any patent licenses granted to You under this License for that Work shall terminate as of the date such litigation is filed.
4. Redistribution. You may reproduce and distribute copies of the Work or Derivative Works thereof in any medium, with or without modifications, and in Source or Object form, provided that You meet the following conditions:
 - a. You must give any other recipients of the Work or Derivative Works a copy of this License; and
 - b. You must cause any modified files to carry prominent notices stating that You changed the files; and
 - c. You must retain, in the Source form of any Derivative Works that You distribute, all copyright, patent, trademark, and attribution notices from the Source form of the Work, excluding those notices that do not pertain to any part of the Derivative Works; and

- d. If the Work includes a "NOTICE" text file as part of its distribution, then any Derivative Works that You distribute must include a readable copy of the attribution notices contained within such NOTICE file, excluding those notices that do not pertain to any part of the Derivative Works, in at least one of the following places: within a NOTICE text file distributed as part of the Derivative Works; within the Source form or documentation, if provided along with the Derivative Works; or, within a display generated by the Derivative Works, if and wherever such third-party notices normally appear. The contents of the NOTICE file are for informational purposes only and do not modify the License. You may add Your own attribution notices within Derivative Works that You distribute, alongside or as an addendum to the NOTICE text from the Work, provided that such additional attribution notices cannot be construed as modifying the License.
- You may add Your own copyright statement to Your modifications and may provide additional or different license terms and conditions for use, reproduction, or distribution of Your modifications, or for any such Derivative Works as a whole, provided Your use, reproduction, and distribution of the Work otherwise complies with the conditions stated in this License.
5. Submission of Contributions. Unless You explicitly state otherwise, any Contribution intentionally submitted for inclusion in the Work by You to the Licensor shall be under the terms and conditions of this License, without any additional terms or conditions. Notwithstanding the above, nothing herein shall supersede or modify the terms of any separate license agreement you may have executed with Licensor regarding such Contributions.
 6. Trademarks. This License does not grant permission to use the trade names, trademarks, service marks, or product names of the Licensor, except as required for reasonable and customary use in describing the origin of the Work and reproducing the content of the NOTICE file.
 7. Disclaimer of Warranty. Unless required by applicable law or agreed to in writing, Licensor provides the Work (and each Contributor provides its Contributions) on an "AS IS" BASIS, WITHOUT WARRANTIES OR CONDITIONS OF ANY KIND, either express or implied, including, without limitation, any warranties or conditions of TITLE, NON-INFRINGEMENT, MERCHANTABILITY, or FITNESS FOR A PARTICULAR PURPOSE. You are solely responsible for determining the appropriateness of using or redistributing the Work and assume any risks associated with Your exercise of permissions under this License.
 8. Limitation of Liability. In no event and under no legal theory, whether in tort (including negligence), contract, or otherwise, unless required by applicable law (such as deliberate and grossly negligent acts) or agreed to in writing, shall any Contributor be liable to You for damages, including any direct, indirect, special, incidental, or consequential damages of any character arising as a result of this License or out of the use or inability to use the Work (including but not limited to damages for loss of goodwill, work stoppage, computer failure or malfunction, or any and all other commercial damages or losses), even if such Contributor has been advised of the possibility of such damages.
 9. Accepting Warranty or Additional Liability. While redistributing the Work or Derivative Works thereof, You may choose to offer, and charge a fee for, acceptance of support, warranty, indemnity, or other liability obligations and/or rights consistent with this License. However, in accepting such obligations, You may act only on Your own behalf and on Your sole responsibility, not on behalf of any other Contributor, and only if You agree to indemnify, defend, and hold each Contributor harmless for any liability incurred by, or claims asserted against, such Contributor by reason of your accepting any such warranty or additional liability.

END OF TERMS AND CONDITIONS

©2022 Bose Corporation

Licensed under the Apache License, Version 2.0 (the "License"); you may not use this file except in compliance with the License.

You may obtain a copy of the License at: <http://www.apache.org/licenses/LICENSE-2.0>

Unless required by applicable law or agreed to in writing, software distributed under the License is distributed on an "AS IS" BASIS, WITHOUT WARRANTIES OR CONDITIONS OF ANY KIND, either express or implied.

See the License for the specific language governing permissions and limitations under the License.

محتوى علبة المنتج

13 المحتويات

تطبيق BOSE MUSIC

14 تنزيل تطبيق Bose Music

14 إضافة سماعات الرأس إلى حساب موجود

أدوات التحكم بالسماعات

16 تشغيل

16 مؤقت وضع الاستعداد

17 إيقاف الطاقة

18 وظائف سماعات الرأس

18 تشغيل الوسائط ومستوى الصوت

19 المكالمات الهاتفية

20 زر الإجراء

خفض التشويش

21 أوضاع إلغاء التشويش

21 تغيير وضع إلغاء الضوضاء

أدوات التحكم بالصوت

22 الوصول إلى عنصر التحكم في الصوت

اتصالات® BLUETOOTH

23 التوصيل باستخدام القائمة Bluetooth في الجهاز المحمول الخاص بك

25 فصل الجهاز المحمول

25 إعادة توصيل أحد الأجهزة المحمولة

25 توصيل جهاز محمول آخر

25 تحديد أجهزة المحمول المتصلة

25 التبديل بين جهازين محمولين متصلين

26 إعادة توصيل جهاز موصل مسبقاً

26 مسح قائمة جهاز السماعة

الاتصالات السلكية

27 توصيل كبل صوت.

البطارية

28 اشحن السماعات.

28 مدة الشحن.

28 الاستماع إلى مستوى البطارية.

حالة سماعات الرأس

29 حالة Bluetooth.

29 حالة البطارية.

30 حالة الشحن.

30 حالة الخطأ والتحديث.

توصيل منتجات BOSE

31 توصيل Bose Smart Speaker أو Soundbar.

31 المزايا.

31 المنتجات المتوافقة.

31 الاتصال باستخدام تطبيق Bose Music.

32 إعادة الاتصال بسماعة Bose Smart Speaker أو مكبر الصوت Soundbar.

العناية والصيانة

33 تخزين سماعات الرأس.

34 تنظيف سماعات الرأس.

34 قطع الغيار والملحقات.

34 ضمان محدود.

35 موقع الرقم المسلسل.

استكشاف الأخطاء وإصلاحها

36	جرب هذه الحلول أولاً
36	حلول أخرى
39	إعادة سماعات الرأس إلى إعدادات المصنع

المحتويات

تأكد من إدراج الأجزاء التالية:

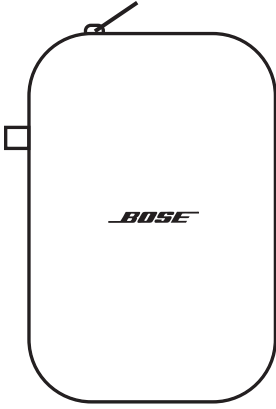

حقيبة الحمل الناعمة



سماعات Bose QuietComfort 45

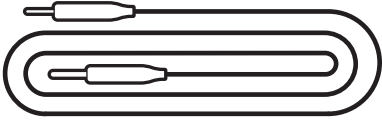

كيل صوت من 3.5 ملم 2.5 ملم

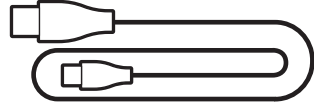

كيل USB من نوع Type-C®

ملاحظة: في حال تلف أي جزء من منتجك، لا تستخدمه. اتصل بموزع Bose المعتمد أو اتصل بخدمة عملاء Bose.

تفضل بزيارة: support.Bose.com/QCSE

يُتيح لك تطبيق Bose Music إعداد السماعات والتحكم بها من أي محمول، مثل الهاتف الذكي أو الكمبيوتر اللوحي. باستخدام هذا التطبيق، يُمكنك إدارة اتصالات *Bluetooth*، وإدارة إعدادات السماعة، واختيار لغة المطالبة الصوتية لديك، والحصول على ميزات جديدة عبر التطبيقات.

ملاحظة: إذا كنت قد أنشأت بالفعل حسابًا على Bose Music لمنتج آخر من منتجات Bose، فأضف السماعات إلى حسابك الحالي (راجع الجزء السفلي من الصفحة 14).

تنزيل تطبيق BOSE MUSIC

1. في جهازك المحمول الخاص بك، نزل تطبيق Bose Music.



2. اتبع تعليمات التطبيق.

إضافة سماعات الرأس إلى حساب موجود

لإضافة سماعات Bose QuietComfort 45 الخاصة بك، افتح تطبيق Bose Music وأضف سماعاتك.

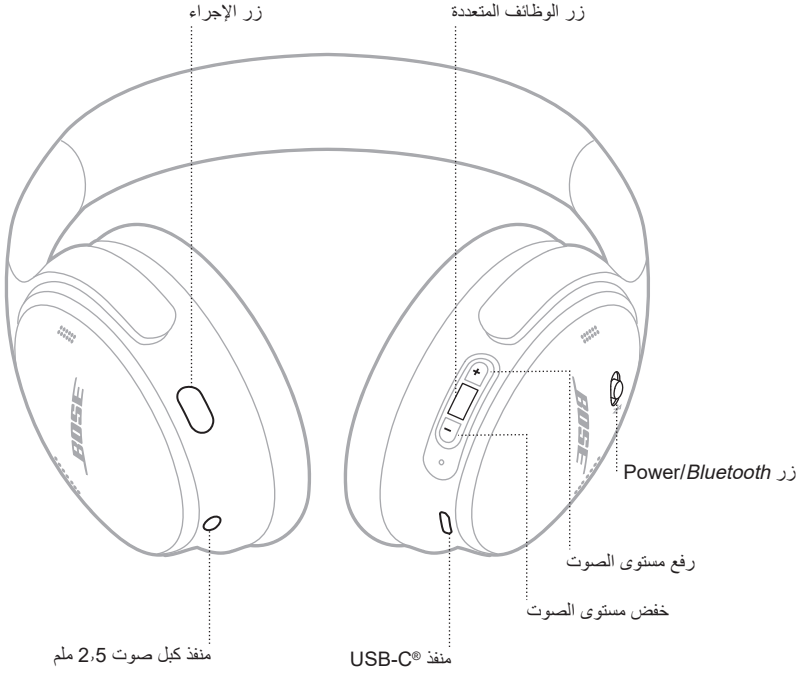

تشغيل

في قطعة الأذن اليمنى، مرر مفتاح *Power/Bluetooth* إلى جهة اليمين. تخبرك المطالبة الصوتية بمستوى شحن البطارية، وبضوء مصباح الحالة حسب مستوى شحن البطارية الحالي (انظر الصفحة 29).



مؤقت وضع الاستعداد

يحافظ مؤقت وضع الاستعداد على البطارية عندما لا تكون السماعات مستخدمة. لإعداد مؤقت وضع الاستعداد وتخصيصه، استخدم تطبيق *Bose Music*.

إيقاف الطاقة

مرر مفتاح Power/Bluetooth إلى جهة اليسار.

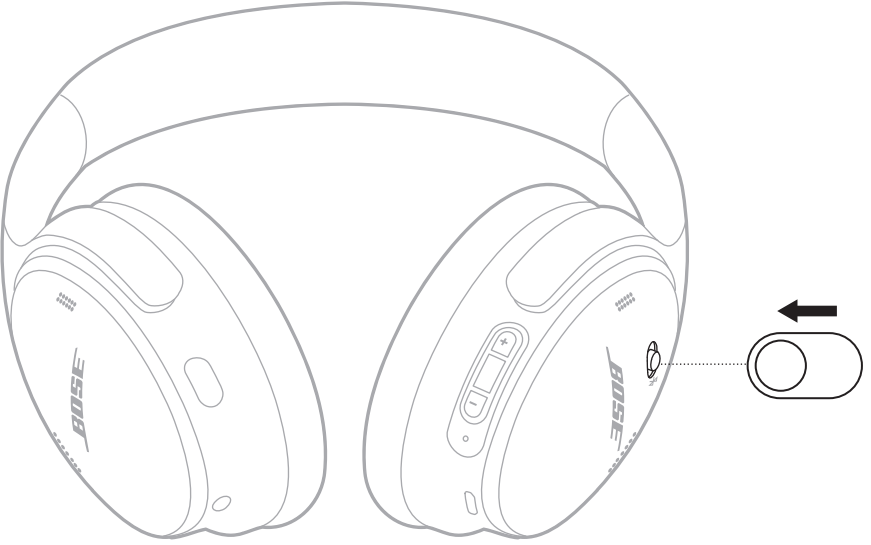

ملاحظة: عند إيقاف تشغيل السماعات، يتم تعطيل خاصية إلغاء الضوضاء.

وظائف سماعات الرأس

توجد أدوات تحكم السماعات على الجزء الخلفي من قطعة الأذن اليمنى.

تشغيل الوسائط ومستوى الصوت

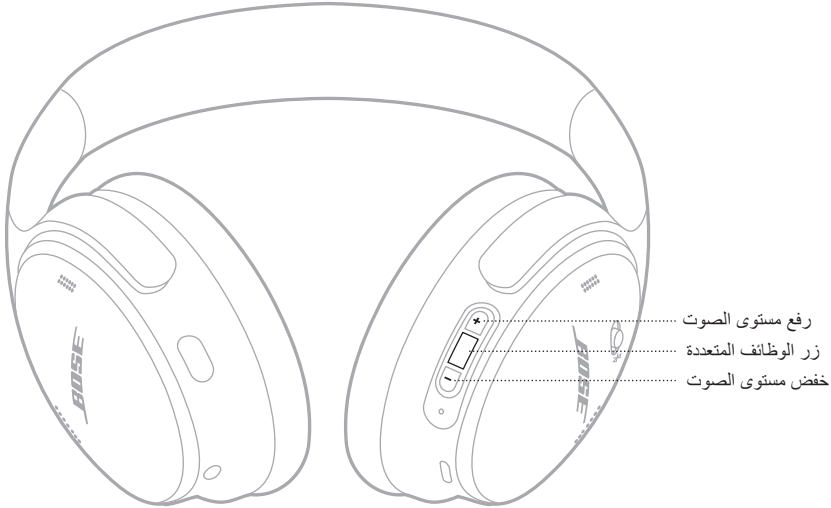

الوظيفة	الحل
تشغيل/إيقاف مؤقت	اضغط على زر الوظائف المتعددة.
تَحطُّ إلى الأمام	اضغط مرتين على زر الوظائف المتعددة.
تَحطُّ للخلف	اضغط ثلاث مرات على زر الوظائف المتعددة.
رفع مستوى الصوت	اضغط على +.
خفض مستوى الصوت	اضغط على -.

ملاحظات:

- لرفع مستوى الصوت بسرعة، اضغط مع الاستمرار على +.
- لخفض مستوى الصوت بسرعة، اضغط مع الاستمرار على -.

المكالمات الهاتفية

يوجد زر الوظائف المتعددة في الجزء الخلفي من قطعة الأذن اليمنى. يقع الميكروفون بالقرب من الجزء الأمامي من قطعة الأذن اليمنى.

يوجد زر الإجراء في الجزء الخلفي من قطعة الأذن اليسرى.

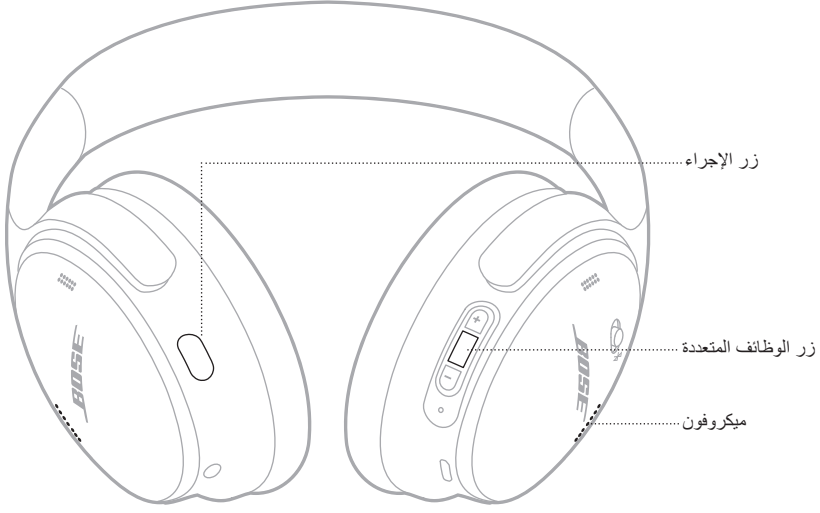

الحل	الوظيفة
اضغط على زر الوظائف المتعددة.	الرد على مكالمة/إنهاء مكالمة
اضغط مع الاستمرار على زر الوظائف المتعددة لمدة ثانية واحدة.	رفض مكالمة هاتفية واردة
أثناء المكالمة مع رنين مكالمة ثانية، اضغط على زر الوظائف المتعددة.	الرد على المكالمة الهاتفية الواردة الثانية ووضع المكالمة الهاتفية الحالية قيد الانتظار
أثناء المكالمة مع رنين مكالمة ثانية، اضغط مع الاستمرار على زر الوظائف المتعددة لمدة ثانية واحدة.	رفض المكالمة الهاتفية الواردة الثانية والاستمرار في المكالمة الهاتفية الحالية
أثناء وجود مكالمتين نشطتين، اضغط مرتين على زر الوظائف المتعددة.	التبديل بين مكالمتين هاتفيتين
أثناء وجود مكالمتين نشطتين، اضغط مع الاستمرار على زر الوظائف المتعددة لمدة 3 ثوانٍ.	إنشاء مكالمة جماعية
أثناء المكالمة، اضغط مرتين على زر الإجراء.	كتم صوت/تشغيل صوت مكالمة

زر الإجراء

يسمح لك زر الإجراء بتغيير أوضاع إلغاء الضوضاء بسرعة وسهولة.

يوجد زر الإجراء في الجزء الخلفي من قطعة الأذن اليسرى.

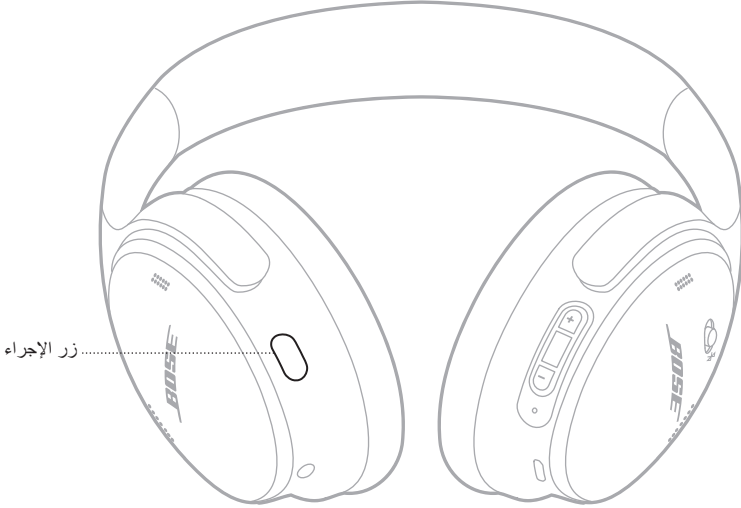

للتبديل بين وضع Quiet ووضع Aware، اضغط على زر الإجراء.

لمزيد من المعلومات حول أوضاع إلغاء التشويش، انظر الصفحة 21.

تُقلل خاصية إلغاء الضوضاء من الضوضاء غير المرغوبة، مما يوفر أداءً صوتيًا أكثر نقاءً وحيوية. يمكنك الاختيار من بين وضعين من أوضاع إلغاء الضوضاء: **Quiet** و **Aware**.

يتيح لك وضع **Quiet** منع عوامل التشويش باستخدام أعلى مستوى من إلغاء الضوضاء.

يوفر وضع **Aware** شفافية كاملة ويتيح لك سماع الأصوات المحيطة بك أثناء الاستمتاع بتسجيلك الصوتي.

اختر وضع إلغاء التشويش الخاص بك حسب تفضيلات الاستماع والبيئة المحيطة بك.

أوضاع إلغاء التشويش

الوضع	الدلالة
Quiet	إلغاء الضوضاء بدرجة عالمية باستخدام الصوت الأمثل التي تنتجه Bose.
Aware	استمع للأصوات المحيطة بك أثناء الاستمتاع بتسجيلك الصوتي.

ملاحظة: عند التشغيل، تنتقل السماع افتراضيًا إلى آخر وضع استخدمته.

تغيير وضع إلغاء الضوضاء

لتغيير وضع إلغاء الضوضاء، اضغط على زر الإجراء.

سنقوم المطالبة الصوتية بإعلامك بوضع إلغاء الضوضاء المحدد.

نصيحة: يمكنك أيضًا تغيير وضع إلغاء الضوضاء باستخدام تطبيق **Bose Music**.

الوصول إلى عنصر التحكم في الصوت

يُمكنك استخدام السماعات للوصول إلى عنصر التحكم بالصوت على جهازك المحمول الخاص بك. للوصول إلى عنصر التحكم بالصوت، اضغط مع الاستمرار على زر الوظائف المتعددة لمدة ثانية واحدة.

يوجد زر الوظائف المتعددة في الجزء الخلفي من قطعة الأذن اليمنى.

ملاحظة: لا يمكنك الوصول إلى عنصر التحكم بالصوت أثناء إجرائك لمكالمات.

التوصيل باستخدام القائمة القائمة في الجهاز المحمول الخاص بك

يمكنك تخزين ما يصل إلى ثمانية أجهزة في قائمة جهاز سماعة الرأس، ويمكن لسماعات الرأس الخاصة بك أن تتصل بجهازين في الوقت نفسه بفاعلية تامة. يُمكنك تشغيل الصوت من جهاز واحد فقط في كل مرة.

ملاحظة: للحصول على أفضل تجربة، استخدم تطبيق Bose Music لإعداد جهازك المحمول وتوصيله (انظر الصفحة 14).

1. مرر مفتاح Power/Bluetooth إلى جهة اليمين * واضغط مع الاستمرار لمدة 3 ثوانٍ.

ستسمع لعبارة "جاهز للاتصال" وسيومض مصباح الحالة باللون الأزرق.



2. مكن ميزة Bluetooth على جهازك.

ملاحظة: يتم العثور عادة على ميزة Bluetooth في قائمة الإعدادات.

3. حدد سماعاتك من قائمة الأجهزة.

نصيحة: ابحث عن الاسم الذي أدخلته لسماعاتك في تطبيق Bose Music. إذا لم تقم بتسمية سماعاتك، فسيظهر الاسم الافتراضي.

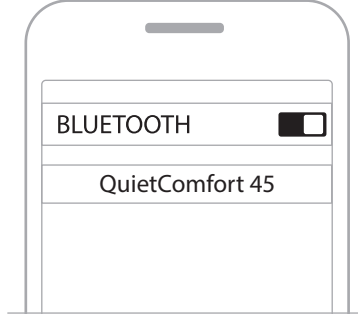

بمجرد التوصيل، ستسمع عبارة "تم التوصيل بـ <اسم الجهاز>"، ويضيء مصباح الحالة بلون أزرق ثابت لمدة 10 ثوانٍ.

فصل الجهاز المحمول

استخدم تطبيق Bose Music لقطع اتصال جهازك المحمول.

نصيحة: يمكنك استخدام إعدادات Bluetooth لقطع اتصال جهازك. ويؤدي تعطيل ميزة Bluetooth على جهازك إلى قطع الاتصال بجميع الأجهزة الأخرى.

إعادة توصيل أحد الأجهزة المحمولة

تحاول السماعات إعادة الاتصال بآخر جهازين تم الاتصال بهما وذلك عند التشغيل.

ملاحظات:

- يجب أن يكون الجهاز في نطاق (30 قدمًا، أو 9 أمتار) وفي وضع التشغيل.
- تأكد من تمكين ميزة Bluetooth على جهازك المحمول.

توصيل جهاز محمول آخر

لتوصيل جهاز إضافي، نزل تطبيق Bose Music (انظر الصفحة 14) أو استخدم قائمة Bluetooth الموجودة في جهازك المحمول (انظر الصفحة 23).

ملاحظة: يمكنك تشغيل الصوت من جهاز واحد فقط في كل مرة.

تحديد أجهزة المحمول المتصلة

مرر مفتاح Power/Bluetooth إلى الجهة اليمنى ✶ واتركه لسماع اسم الجهاز المتصل حاليًا.

التبديل بين جهازين محمولين متصلين

1. أوقف تشغيل المقطع الصوتي مؤقتًا على جهازك المحمول الأول.
2. شغل المقطع الصوتي بجهاز المحمول الثاني.

ملاحظة: يمكن لسماعاتك تلقي مكالمات هاتفية من كلا الجهازين، بغض النظر عن أي جهاز منهما الذي يقوم بتشغيل الصوت.

إعادة توصيل جهاز موصل مسبقاً

1. مرر مفتاح *Power/Bluetooth* إلى جهة اليمين ✳️ واتركه لسماع اسم الجهاز المتصل.
 2. في خلال ثانيتين، مرر مفتاح *Power/Bluetooth* إلى جهة اليمين ✳️ واتركه مجدداً للاتصال بالجهاز التالي في قائمة أجهزة السماعات.
 3. كرر ذلك إلى حين سماع اسم الجهاز الصحيح.
ستسمع نغمة تشير إلى أن الجهاز متصل.
 4. شغل الصوت على الجهاز المحمول المتصل.
- ملاحظة:** إذا كان هناك جهازان متصلان بالفعل بالسماعات، فإن الجهاز المتصل حديثاً يحل محل الجهاز الثاني الذي تم توصيله مسبقاً.

مسح قائمة جهاز السماع

1. مرر مفتاح *Power/Bluetooth* إلى جهة اليمين ✳️ واضغط مع الاستمرار عليه لمدة 15 ثانية، حتى تسمع عبارة "تم مسح قائمة جهاز *Bluetooth*. جاهز للاتصال".
2. احذف سماعات الرأس الخاصة بك من القائمة *Bluetooth* في جهازك المحمول.
تم مسح جميع الأجهزة وأصبحت السماعات جاهزة للتوصيل.

توصيل كبل صوت

استخدم كبل 2.5 ملم إلى 3.5 ملم لتوصيل جهاز سلكي أو للاستمرار في استخدام السماعات في حال نفاذ شحن البطارية.
1. وصل الكبل بمنفذ 2.5 ملم الموجود في قطعة الأذن اليسرى.



2. وصل الطرف الآخر للكبل في منفذ 3.5 ملم في جهازك.

ملاحظة: يُمكنك استخدام سماعات الرأس التي تم تشغيلها أو إيقاف تشغيلها عند توصيل كبل الصوت.

إشحن السماعات

1. وصل الطرف الصغير لكبل USB بمنفذ USB-C الموجود في قطعة الأذن اليمنى.
2. وصل الطرف الآخر بشاحن حائط USB.



ملاحظات:

- عند بدء شحن السماعات، يومض مصباح الحالة باللون الأبيض لمدة 10 ثوانٍ. عند اكتمال الشحن، يُضيء مصباح الحالة باللون الأبيض الثابت.
- لن تعمل السماعات أثناء الشحن.

مدة الشحن

اشحن سماعات الرأس لمدة تصل إلى ساعتين ونصف لشحنها بالكامل.

الاستماع إلى مستوى البطارية

في كل مرة تُشغل فيها السماعات، تقوم مطابلية صوتية بالإعلان عن مستوى شحن البطارية. عندما تكون بطارية السماعة منخفضة، ستسمع إلى رسالة تقول "البطارية منخفضة، يرجى الشحن الآن".

ملاحظة: لفحص البطارية بصريًا، انظر إلى مصباح الحالة الموجود عند قطعة سماعة الأذن اليمنى. لمزيد من المعلومات، انظر "حالة البطارية" في الصفحة 29.

يقع مصباح الحالة على قطعة الأذن اليمنى.

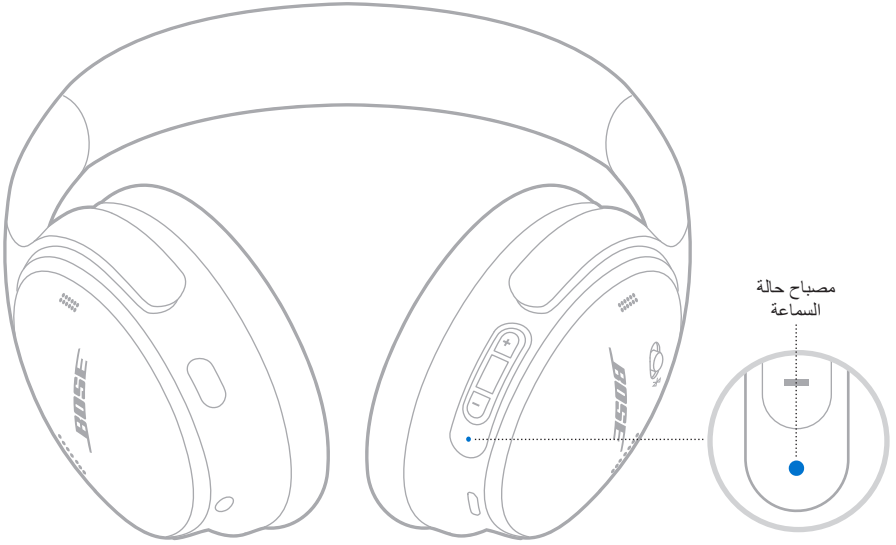

حالة BLUETOOTH

تعرض حالة اتصال Bluetooth.

حالة النظام	نشاط الضوء
جاهز للاتصال	أزرق وامض
تم الاتصال	أزرق ثابت (لمدة 10 ثوان)

حالة البطارية

تُوضح مستوى شحن البطارية.

حالة النظام	نشاط الضوء
شحن متوسط إلى كامل	أبيض ثابت
شحن منخفض	كهرماني ثابت

نصيحة: يُمكنك أيضًا التحقق من مستوى شحن البطارية باستخدام تطبيق Bose Music.

حالة الشحن

تعرض حالة الشحن.

حالة النظام	نشاط الضوء
تبدأ عملية الشحن	تومض باللون الأبيض مرتين
جارِ الشحن	كهرماني ثابت
شحن كامل	أبيض ثابت

حالة الخطأ والتحديث

تعرض حالة الخطأ والتحديث.

حالة النظام	نشاط الضوء
جارِ تحديث البرنامج (باستخدام USB)	وميض أبيض سريع (لمدة 10 ثوانٍ)
جارِ تحديث البرنامج (لاسلكيًا)	وميض أبيض بطيء (لمدة 30 إلى 60 ثانية)
خطأ - اتصل بخدمة عملاء شركة Bose	وميض كهرماني وأبيض

توصيل SOUNDBAR أو BOSE SMART SPEAKER

باستخدام تقنية SimpleSync™، يمكنك توصيل سماعات الرأس بمكبر صوت Bose Smart Soundbar أو سماعات Bose Smart Speaker للاستمتاع بتجربة استماع شخصية.

المزايا

- استخدم عناصر التحكم في الصوت المستقلة في كل منتج لخفض مكبر الصوت Bose Smart أو كتمه مع الاستمتاع بالصوت في سماعات الرأس كما تريد.
- اسمع موسيقاك بوضوح من الغرفة المجاورة من خلال توصيل سماعات الرأس بسماعة Bose Smart Speaker الخاصة بك.

ملاحظة: تتميز تقنية SimpleSync™ بنطاق Bluetooth يصل إلى 30 قدمًا (9 أمتار). قد تؤثر الجدران ومعدات البناء على الاستقبال.

المنتجات المتوافقة

يمكنك توصيل سماعات الرأس بأي من مكبرات الصوت Bose Smart Speaker أو سماعات Bose Smart Soundbar.

تشمل المنتجات المتوافقة الشائعة ما يلي:

- Bose Smart Soundbar 700/Bose Soundbar 700
 - Bose Soundbar 500
 - Bose Smart Speaker 500/Bose Home Speaker 500
 - سماعة Bose Home Speaker 300
 - Bose Portable Smart Speaker/Bose Portable Home Speaker
- كما تُضاف منتجات جديدة بانتظام. للحصول على قائمة كاملة والمزيد من المعلومات، تفضل بزيارة: worldwide.Bose.com/Support/Groups

الاتصال باستخدام تطبيق Bose Music

1. في السماعات، مرر مفتاح Power/Bluetooth إلى جهة اليمين ⌘ واضغط مع الاستمرار لمدة 3 ثوانٍ.

ستسمع عبارة "جاهز لتوصيل جهاز آخر" وسيومض مصباح الحالة باللون الأزرق.

2. استخدم تطبيق Bose Music لتوصيل سماعات الرأس بمنتج متوافق من Bose. للمزيد من المعلومات، تفضل بزيارة: worldwide.Bose.com/Support/Groups

ملاحظات:

- تأكد من أن السماعات تقع على بعد 30 قدمًا (9 أمتار) من مكبر الصوت أو السماعة الخاصة بك.
- يمكنك توصيل سماعات الرأس بمنتج واحد فقط في كل مرة.

إعادة الاتصال بسماعة BOSE SMART SPEAKER أو مكبر الصوت SOUNDBAR

شغّل سماعات الرأس (انظر "تشغيل" في الصفحة 16).

تحاول سماعات الرأس الاتصال بآخر جهازين *Bluetooth* تم الاتصال بهما، بما في ذلك مكبر الصوت أو السماعة.

ملاحظات:

- يجب أن يكون مكبر الصوت أو السماعة الخاصة بك ضمن نطاق (30 قدمًا أو 9 أمتار) وفي وضع التشغيل.
- إذا لم تتم إعادة الاتصال بسماعات الرأس، فانظر "لا تتم إعادة توصيل Bose Smart Soundbar أو السماعة التي تم توصيلها مسبقًا" في الصفحة 38.

تخزين سماعات الرأس

يتم تدوير قطعتي الأذن لتخزينهما بسهولة وبطريقة مريحة. ضع سماعات الرأس في وضع مسطح في الجراب.

1. قم بتدوير قطعتي الأذن إلى الداخل كي تكونا في وضع مسطح.



2. قم بطي قطعة سماعة الأذن اليسرى للأعلى باتجاه عصابة الرأس.

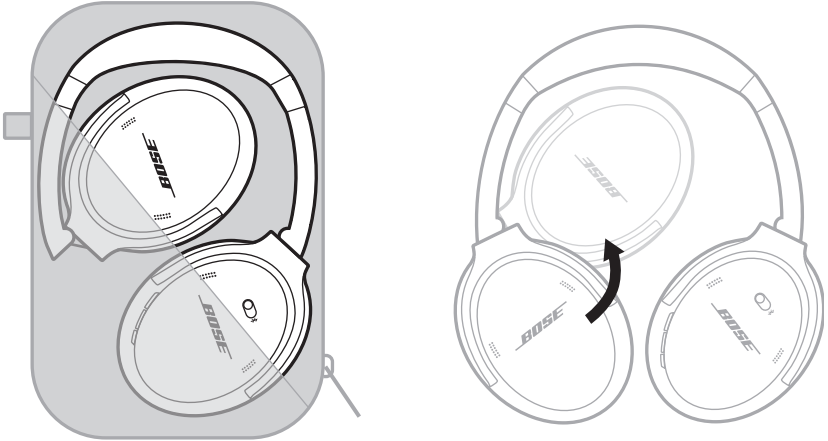

ملاحظات:

- تأكد من إيقاف تشغيل سماعات الرأس في حال عدم استخدامها.
- تأكد من أن البطارية مشحونة بالكامل قبل تخزين سماعات الرأس لأكثر من بضعة شهور.

تنظيف سماعات الرأس

امسح السطح الخارجي بقطعة قماش ناعمة وجافة.

لا تسمح للرطوبة بدخول قطعتي الأذن.

قطع الغيار والملحقات

يمكن طلب قطع الغيار أو الملحقات من خلال مركز خدمة عملاء Bose. يُرجى التفضّل بزيارة:
support.Bose.com/QCSE

ضمان محدود

تتم تغطية السماعات الخاصة بك بضمان محدود. تفضل بزيارة موقعنا على worldwide.Bose.com/Warranty للحصول على تفاصيل الضمان المحدود.

لتسجيل المنتج الخاص بك، قم بزيارة worldwide.Bose.com/ProductRegistration للحصول على التعليمات. ولن يؤثر عدم القيام بالتسجيل على الحقوق المكفولة لك بموجب الضمان المحدود.

موقع الرقم المسلسل

يوجد الرقم المسلسل داخل قطعة الأذن اليمنى أسفل السكريم. السكريم هو شاشة داخلية يغطي المكونات داخل قطعة الأذن وتحميها.

لعرض الرقم المسلسل، اسحب السكريم على الطرف العلوي وأزحه بعيدًا برفق.

تنبيه: احرص على عدم الضغط على أي مكونات أخرى داخل قطعة الأذن أو إزالتها لأن ذلك قد يؤدي إلى تلف سماعات الرأس.

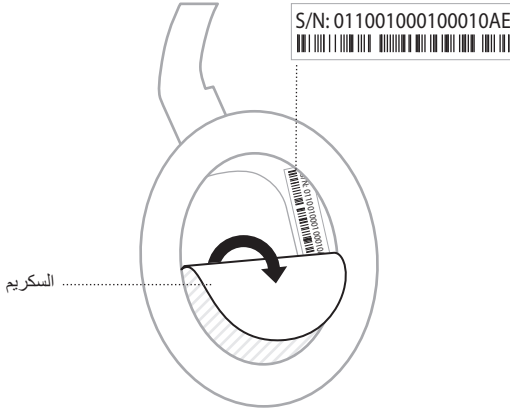

جرب هذه الحلول أولاً

إذا واجهت مشكلات بشأن سماعاتك:

- تحقق من وضع مصباح الحالة (انظر الصفحة 29).
- اشحن البطارية (انظر الصفحة 28).
- ارفع مستوى الصوت في سماعاتك وجهازك المحمول وتطبيق الموسيقى.
- نزل تطبيق Bose Music وتشغيل تحديثات البرامج المتاحة (انظر الصفحة 14).
- جرب توصيل جهاز محمول آخر (انظر الصفحة 25).

إذا لم تستطع حل المشكلة لديك، فراجع الجدول أدناه لتحديد الأعراض والحلول للمشكلات الشائعة. وإذا كنت غير قادر على حل هذا الأمر، فيرجى الاتصال بخدمة عملاء Bose.

تفضل بزيارة: worldwide.Bose.com/contact

حلول أخرى

العرض	الحل
سماعات الرأس لا تعمل	اشحن البطارية.
لا تتصل السماعات بجهازك المحمول	افصل كبل الصوت الاحتياطي. افصل كبل شحن USB. في جهازك المحمول: عطّب ميزة Bluetooth ثم أعد تمكينها. احذف السماعات Bose QuietComfort 45 الخاصة بك من قائمة Bluetooth على جهازك، بما في ذلك أي قوائم مكررة تحمل اسم LE (الطاقة المنخفضة). قم بالتوصيل مرة أخرى. ضع جهازك المحمول قريبًا من السماعات وأبعد عنهما أي تداخلات أو عوائق. تفضل بزيارة support.Bose.com/QCSE للاطلاع على مقاطع فيديو توضيحية. امسح قائمة الأجهزة المتصلة (انظر الصفحة 26) وقم بالتوصيل مرة أخرى.
البطارية لن تقوم بالشحن	قم بحماية أطراف كبل الشحن USB. جرب مصدر شحن آخر. إذا تعرضت سماعاتك لدرجات حرارة عالية أو منخفضة، فدع السماعات تستعيد درجة حرارة الغرفة وأعد محاولة شحنها.

الحل	العَرَض
<p>قم بتشغيل السماعات واشحن البطارية. تحقق من وضع مصباح الحالة (انظر الصفحة 29). مرر مفتاح Power/Bluetooth إلى جهة اليمين وحرره لتسمع اسم الجهاز المتصل. تأكد من أنك تستخدم الجهاز الصحيح. ضع جهازك المحمول قريبًا من السماعات وأبعد عنهما أي تداخلات أو عوائق. استخدم مصدرًا مختلفًا للموسيقى. إذا تم توصيل جهازين محمولين، فأوقف جهازك الآخر أولاً. في حال اتصال جهازين محمولين، انقل الجهازين ليصبحا في نطاق السماعات (30 قدمًا أو 9 أمتار). جرب ملف الفيديو أو الموسيقى المخزنة محليًا على جهازك المحمول.</p>	<p>لا يصدر أي صوت</p>
<p>استخدم مصدرًا مختلفًا للموسيقى. وصّل جهازًا محمولًا آخر (انظر الصفحة 25). افصل الجهاز الثاني. ضع جهازك المحمول قريبًا من السماعات وأبعد عنهما أي تداخلات أو عوائق. جرب ملف الفيديو أو الموسيقى المخزنة محليًا على جهازك المحمول.</p>	<p>جودة الصوت رديئة</p>
<p>قم بحماية أطراف كبل الصوت الاحتياطي. ارفع مستوى صوت سماعات الرأس، وجهازك المحمول ومصدر الموسيقى. قم بتوصيل جهاز آخر (انظر الصفحة 25).</p>	<p>لا يصدر أي صوت من جهاز متصل بواسطة كبل الصوت الاحتياطي</p>
<p>قم بحماية أطراف كبل الصوت الاحتياطي. قم بتوصيل جهاز آخر (انظر الصفحة 25).</p>	<p>جودة الصوت رديئة من جهاز موصل بكبل الصوت</p>
<p>تأكد من أنه تم تشغيل سماعاتك. استخدم تطبيق Bose Music لتغيير وضع إلغاء الضوضاء.</p>	<p>لا يقوم زر الإجراء بتغيير وضع إلغاء الضوضاء</p>
<p>اضغط مع الاستمرار على زر Power/Bluetooth حتى تسمع عبارة "جاهز لتوصيل جهاز آخر"، وحتى يومض مصباح Bluetooth باللون الأزرق. تأكد من أن السماعات تقع على بعد 30 قدمًا (9 أمتار) من مكبر الصوت أو السماعة الخاصة بك.</p>	<p>لا يتم توصيل سماعات الرأس بمكبر الصوت أو سماعات Bose Smart</p>

الحل	العَرَض
جرب إعادة توصيل جهاز تم توصيله سابقًا (انظر الصفحة 26).	لا تتم إعادة توصيل Bose Smart Soundbar أو السماعة التي تم توصيلها مسبقًا
نزل تطبيق Bose Music وشغل تحديثات البرامج المتاحة.	تأخر الصوت عند الاتصال بمكبر الصوت أو سماعات Bose Smart

يمكن أن تؤدي استعادة إعدادات المصنع إلى مسح جميع الإعدادات وإعادة سماعات الرأس إلى حالتها الأصلية الأفضل. بعد ذلك، يمكن تكوين سماعات الرأس كما لو تم إعدادها لأول مرة.

يوصى باستعادة إعدادات المصنع فقط إذا كنت تواجه مشكلات مع سماعات الرأس، أو إذا تلقيت تعليمات لفعل ذلك من قبل خدمة عملاء Bose.

إعادة سماعات الرأس إلى إعدادات المصنع

1. أزل سماعات الرأس من قائمة *Bluetooth* الموجودة على جهازك.

2. أزل سماعات الرأس من حساب Bose الخاص بك باستخدام تطبيق Bose Music.

ملاحظة: للحصول على المزيد من المعلومات حول إزالة سماعات الرأس من حساب Bose الخاص بك باستخدام تطبيق Bose Music، تفضل بزيارة: support.bose.com/QCSE

3. مرر مفتاح *Power/Bluetooth* إلى جهة اليمين ✶ واضغط مع الاستمرار. وفي الوقت نفسه، اضغط مع الاستمرار على زر الإجراء لمدة 30 ثانية.

يُومض مصباح الحالة باللون الأبيض. بعد 30 ثانية، يومض مصباح الحالة باللون الكهرماني للإشارة إلى استعادة إعدادات المصنع (من 2 إلى 3 ثوانٍ).

4. عند اكتمال الاستعادة، يومض مصباح الحالة ببطء باللون الأزرق. أصبحت سماعات الرأس الآن في حالتها الأصلية الأفضل.



878541-0010