

HUAWEI WATCH GT 3 Pro

USER GUIDE



Contents

Getting Started

Buttons and gestures	1
Pairing and connecting to wearable devices	2
Charging	4
Turning on the screen	5
Wearing the watch	5

Exercise

Starting a workout	7
Smart companion	7
Making running plans	8
Viewing the RAI	8
Measuring the lactic threshold	9
Diving	9
Viewing workout records	10
Recording daily activities	10
Automatic workout detection	10
Route back	11

Health Management

ECG	12
Measuring your skin temperature	13
Healthy Living	14
Sleep monitoring	15
Measuring SpO2	16
Automatic SpO2 measurements	16
Measuring your heart rate	17
Stress test	18
Activity reminder	19
Menstrual cycle predictions	19

Assistant

HUAWEI Assistant·TODAY	21
Apps	21
Message management	22
Rejecting incoming calls	23
Viewing call logs	23
Controlling music playback	23
Flashlight	24
Compass	24
Remote shutter	25

More

Voice assistant	25
Adjusting and changing the strap	26
Configuring Gallery watch faces	28
Setting the AOD watch face	28
Managing watch faces	28
Setting favorite contacts	29
Setting the time and language	30
Customizing the function of the Down button	30
Adding custom cards	30
Adjusting the screen brightness	30
Update	30
Powering on, powering off, and restarting your watch	31

Getting Started

Buttons and gestures

The watch is equipped with a color touchscreen that is highly touch-responsive and can be swiped in different directions.

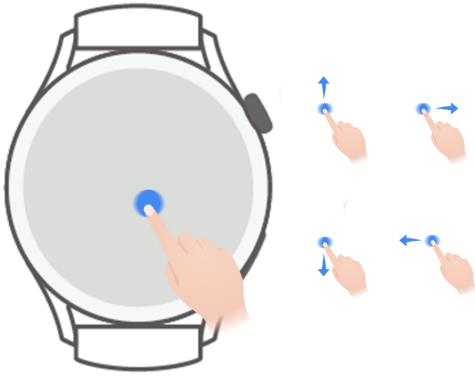

Up button

Operation	Function	Remarks
Rotate	<ul style="list-style-type: none">• In Grid mode, zoom in and out on an app on the app list screen.• In List mode, swipe up and down on the app list screen or the details screen.• Scroll up and down the screen after you enter an app. <p>i To enable Grid or List mode on your watch, go to Settings > Watch face & launcher > Launcher and select Grid or List.</p>	There are certain exceptions such as for calls and workouts.
Press	<ul style="list-style-type: none">• Turn on the screen.• Open the app list screen from the home screen.• Return to the home screen.• Mute an incoming Bluetooth call.	There are certain exceptions such as for calls and workouts.
Press and hold	<ul style="list-style-type: none">• Power on the watch.• Access the restart/power-off screen when the watch is powered on.• Forcibly restart the watch by pressing and holding the button for more than 12 seconds.	There are certain exceptions such as for calls and workouts.

Down button

Operation	Function	Remarks
Press	Open the Workout app. Access the set customized app.	There are certain exceptions such as for calls and workouts.
Press and hold	Wake up the voice assistant.	-

Gestures

Operation	Function
Touch	Confirm your selection.
Touch and hold	Change the watch face.
Swipe up	View notifications.
Swipe down	View the shortcut menu.
Swipe left or right	View watch feature cards or enter the Assistant·TODAY screen.
Swipe right	Return to the previous screen.

Pairing and connecting to wearable devices

Ensure that your phone meets all the following requirements:

- Download and install the latest version of the Huawei Health app.
- Bluetooth and location services are enabled on your phone, and the Huawei Health app is authorized to access your phone's location.
 -  When you power on your device for the first time or pair it after a factory reset, you will be prompted to select a language before pairing.

Installing the Huawei Health app

Before pairing, download and install the Huawei Health app on your phone. If you have installed the Huawei Health app, update it to the latest version.

• HUAWEI phones

The Huawei Health app is installed on your phone by default. If you are unable to find this app on your phone, you can download and install it from AppGallery.

• Non-HUAWEI Android phones

If you are using a non-HUAWEI Android phone, you can download and install the Huawei Health app through either of the following ways:

- Visit Download the Huawei Health app, or scan the following QR code to download and install the Huawei Health app.



- Search for the **Huawei Health** app in the app store on your phone, and follow the onscreen instructions to download and install the app.



- **iPhones**

Search for the **HUAWEI Health** app in the App Store, and follow the onscreen instructions to download and install the app.



Pairing and connecting to wearable devices

- **i** To protect your privacy, your watch will need to be restored to its factory settings in certain scenarios (subject to the onscreen instructions) when it connects to a new phone. Restoring the watch to its factory settings will clear all data from the device. Please exercise caution when performing this operation.

- **HUAWEI/Non-HUAWEI Android phones**

- 1 After the device is powered on, select a **language**. Bluetooth is ready for pairing by default.
- 2 Place the device close to your phone, open the Huawei Health app on your phone, touch  in the upper right corner, and then touch **ADD**. Your phone will automatically scan for available devices. Select the device you wish to pair with, and touch **LINK**.
- 3 When a pairing request is displayed on the device screen, touch , and follow the onscreen instructions to complete the pairing.

- **iPhones**

- 1 After the device is powered on, select a **language**. Bluetooth is ready for pairing by default.
- 2 Follow the onscreen instructions to go to **Settings > Bluetooth** and select your device for pairing. Once a pairing request is displayed on the device screen, touch .
- 3 You can place your device close to your phone, open the Huawei Health app on your phone, touch  in the upper right corner, touch **ADD**, and then follow the onscreen instructions to select your device from the pop-up window.

Or you can open the Huawei Health app on your phone, touch  in the upper right corner, and then touch **SCAN** to scan the QR code on your device. On your phone, follow the onscreen instructions and touch **Yes > Next**.

- 4 When a pop-up window on your phone requests a Bluetooth pairing via the Huawei Health app, touch **Pair**. Another pop-up window will display, asking you whether to allow the device to display phone notifications. Touch **Allow**.

- 5 Wait for several seconds until the Huawei Health app displays a message indicating that the pairing is successful. Touch **Done** to complete the pairing.

Charging

Charging

- 1 Connect the charging cradle to a power adapter and then connect the power adapter to a power supply.
- 2 Rest your watch on top of the charging cradle and align the metal contacts on your watch to those of the charging cradle until a charging icon appears on the watch screen.

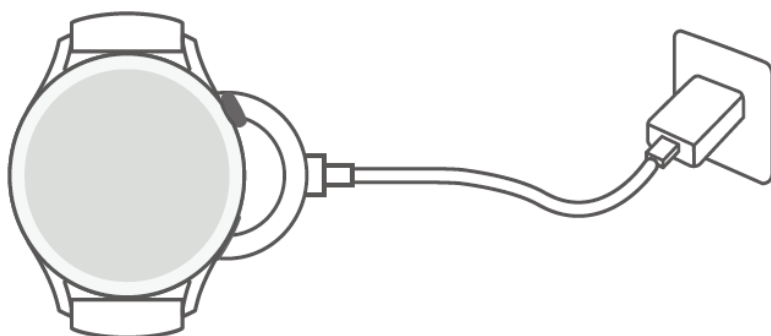

- 3 Remove the watch and disconnect the power adapter after the watch is fully charged and the charging icon displays 100%.

- **i** You are advised to use a Huawei charger or a non-Huawei charger that complies with corresponding regional or national laws and regulations as well as regional and international safety standards to charge your watch. Other chargers and power banks that do not meet corresponding safety standards may cause issues such as slow charging and overheating. Exercise caution when using them. It is recommended that you purchase a Huawei power adapter from an official Huawei sales outlet.
- Keep the charging port dry and clean to prevent short circuits or other risks.
- The charging cradle tends to attract metal objects due to it being magnetic. Therefore, it is necessary to check and clean the charging cradle before use. Do not expose the charging cradle to high temperatures for a long time, as this may cause the charging cradle to demagnetize or cause other exceptions.

Checking the battery level

Method 1: Swipe down from the top of the home screen to check the battery level.

Method 2: Connect your watch to a power supply and check the battery level on the charging screen.

Method 3: View the battery level on a watch face that displays the battery level.

Method 4: Connect your watch to the Health app, open the Health app, touch **Devices** then your device name, and check the battery level on the device details screen.

Turning on the screen

Waking the screen

Press the button to wake the screen.

Turning on the screen

- Press the Up button.
- Raise or rotate your wrist inwards.
- Swipe down on the home screen to open the shortcut menu. Enable **Screen on** for the screen to stay on for five minutes.

 To set a different duration for the screen to stay on, go to **Settings > Display & brightness > Screen on**.

Turning off the screen

Perform no operations for a period of time after you turn on the screen by pressing the button or raising your wrist.

Cover the entire screen to turn off the screen.

-  • To set a duration for the screen to stay off, go to **Settings > Display & brightness > Sleep** to set a duration.
- To enable the watch face and some app screens to stay on, go to **Settings > Watch face & home** and enable **AOD**.
- To change the AOD style, go to **Settings > Watch face & home > AOD style > Default style** and select a different AOD style.

Wearing the watch

Ensure that the rear cover of the watch is clean, dry, and free of foreign objects. Attach the monitoring area of the watch to your wrist and make sure it feels comfortable. Do not attach a protective film to the rear of the watch. The rear cover of the watch has sensors that can identify signals from the human body. If the sensors are blocked, the identification will be inaccurate or fail and the watch won't be able to accurately record the heart rate, SpO2, and sleep data.

To ensure the accuracy of measurements, avoid wearing the strap more than one finger width away from your wrist bone. Ensure that the strap is worn relatively tightly and ensure it is secure during workouts.

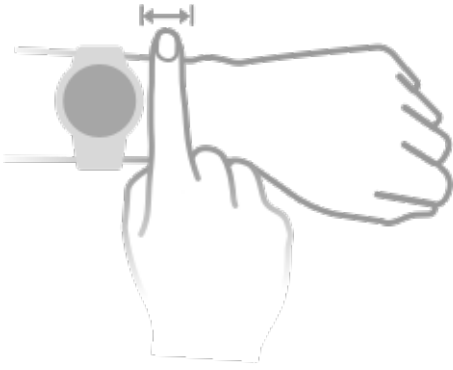

- i** The device is made of materials that are safe to use. If you experience skin discomfort when wearing the device, take it off and consult a doctor.

Exercise

Starting a workout

Starting a workout on your watch

- 1 Enter the app list of your watch and touch **Workout**.
- 2 Select the workout you want to do or your preferred course. Alternatively, swipe up on the screen and touch **Custom** to add other workout modes.
- 3 Touch the Start icon to start a workout session. (Ensure that GPS positioning is working before you start an outdoor workout.)
- 4 To end a workout session, press the Up button and touch the Stop icon, or press and hold the Up button.
 - For devices that support voice broadcasts, press the Up button to pause the workout and then adjust the volume during a workout.
 - Swipe left or right on the screen to switch between the music, sunrise/sunset, and other screens.

Starting a workout in the Huawei Health app

- This feature is not available in the Health app on tablets.

To start a workout using the Huawei Health app, put your phone and watch close to each other to ensure that they are connected.

- 1 Open the Huawei Health app, touch **Exercise**, choose a workout mode, and touch the Start icon to start a workout.
- 2 Once you have started a workout, your watch will sync and display your workout heart rate, speed, and time. Your workout data, such as the workout time, will be displayed in the Huawei Health app.

Smart companion

Enabling Smart companion

After Smart companion is enabled, you can view how much you have exceeded or fallen behind the target pace in real time during an outdoor workout.

- 1 Press the Up button to access the app list and touch **Workout**.
- 2 Touch the Settings icon to the right of **Outdoor run** and enable **Smart companion**.
- 3 Touch **Target pace** to customize a target running pace.
- 4 Return to the app list, touch **Outdoor run**, wait until GPS positioning is complete, and touch the Run icon to start running.

Making running plans

The device provides customized scientific training plans that adapt to your time to meet your training requirements. The device can help you finish your plan in a timely manner and intelligently adjust the difficulty of subsequent courses based on your training status and feedback.

Creating a running plan

- 1 Open the Huawei Health app, go to **Exercise > Outdoor run** or **Indoor run > AI running plan**, select a running plan, and follow the onscreen instructions to finish creating the plan.
Once created, the plan will be automatically synced to your watch when your watch is connected to the app.
- 2 Press the Up button on your watch to enter the app list and go to **Workout > Courses & plans > Training plan** to view your running plan. On the training day, touch the Workout icon to start a workout.

Ending a running plan

Open the Health app, go to **Exercise > Plan**, touch  in the upper right corner, and touch **End plan**.

Other settings

Open the Health app, go to **Exercise > Plan**, and touch  in the upper right corner:

Touch **View plan** to view the plan details.

Touch **Sync to wearable device** to sync plans to your wearable device.

Touch **Plan settings** to edit information such as the training day, reminder time, and whether to sync the plan to the calendar.

Viewing the RAI

Running Ability Index (RAI) is a comprehensive index that reflects a runner's endurance and technique efficiency. It is based on a runner's best times. In general, a runner with a higher RAI performs better in competitions.

Before you start

- To use this feature, update the device and the Huawei Health app to their latest versions.
- The RAI feature is only available for outdoor running and running courses that last for more than 12 minutes. Indoor running is not supported.

Viewing the RAI

- On the device:

- 1 Go to **Settings** > **Watch face & home** > **Home**, and select **Grid** to display the apps in grid view.
 - 2 Touch  to view the RAI.
- On your phone: Open the Huawei Health app, go to **Exercise** > **Outdoor run** > **Total distance run (km)**, select a running record, and touch **Graph** to view your fitness data such as RAI, pace zone, and training load level.

Measuring the lactic threshold

Before you measure the lactic threshold, you need to complete information about your gender, age, height, and weight in the Health app, ensure that the GPS positioning is normal, and go to an open area.

- 1 Press the Up button on your watch to enter the app list, start a lactic threshold measurement, confirm your information, and touch **OK**.
- 2 Ensure that the requirements are met, touch **OK**, and follow the onscreen instructions to start measuring the lactic threshold.
- 3 After the measurement is complete, touch **Workout records** to view the result.

Diving

Diving is risky, so ensure that you have obtained a diving qualification and are accompanied by a diving coach or a partner with diving experience when doing this workout.

Apnea training

After Apnea training is enabled, the watch will prompt you to breathe and hold breath according to the customized training table and record the heart rate data during the training. Press the Up button on your watch to enter the app list, go to **Workout** > **Dive** > **Apnea training**, and follow the onscreen instructions to start training.

Apnea test

Before the apnea test, you can adjust your breath, and the watch will prompt you to start an apnea test. During the test, data of your breath-holding duration and real-time heart rate is provided.

Press the Up button on your watch to enter the app list, go to **Workout** > **Dive** > **Apnea test**, and follow the onscreen instructions to start testing. During the apnea test, press the Down button to record diaphragm contraction.

Freediving

- 1 Press the Up button on your watch to enter the app list, and go to **Workout** > **Dive** > **Freediving**.

- 2 Touch  on the right to set the reminder, reminder method, warning, water type, and auto-detect status.
- 3 Touch the start icon (or press the Down button) to start the workout.
- 4 Press and hold the Up button to end the workout.

Viewing workout records

Viewing workout records on the device

- 1 On the device, enter the app list and touch **Workout records**.
- 2 Select a record and view the corresponding details. The device will display different data types for different workouts.

Viewing workout records in the Huawei Health app

You can also view detailed workout data under **Exercise records** on the **Health** screen in the Huawei Health app.

Deleting a workout record

Touch and hold a workout record on **Exercise records** in the Huawei Health app and delete it. However, this record will still be available in **Workout records** on the device.

Recording daily activities

Wear your watch correctly for it to automatically record data relating to calories burned, distance covered, step count, duration of moderate-to-high intensity activities, and other daily activities.

Press the Up button to access the app list, swipe until you find **Activity records**, touch it, and then swipe up or down to view data relating to calories, distance, steps, duration of moderate-to-high intensity activities, and other activities.

Automatic workout detection

Go to **Settings** > **Workout settings** and enable **Auto-detect workouts**. After this feature is enabled, the device will remind you to start a workout when it detects increased activity. You can ignore the notification or choose to start the corresponding workout.

-  The supported workout types are subject to the onscreen instructions.
- The device will automatically identify your workout mode and remind you to start a workout if you meet the requirements based on the workout posture and intensity and stay in this state for a certain period of time.
- If the actual workout intensity is lower than that required by the workout mode for a certain period of time, the device will display a message indicating that the workout has ended. You can ignore the message or end the workout.

Route back

When you start an outdoor workout and enable the Route back feature, the device will record the route you took and provide you with navigation services. After reaching your destination, you can use this feature to find out how to return to where you passed through or came from.

On your device, enter the app list, then swipe until you find **Workout** and touch it. Start an individual outdoor workout session. Swipe left on the screen and select **Route back** or **Straight line** to return to the starting point. If there is no **Route back** or **Straight line** on the screen, touch the screen to display it.

Health Management

ECG

An electrocardiogram (ECG) is a graphical recording of the heart's electrical activity. ECGs provide an insight into your heart rhythm, and can help to identify irregular heart beats, and detect potential health risks early.

 Currently, this feature is only supported in certain countries and regions.

Before you start

- This feature should not be used by those under 18 years of age.
- Those with pacemakers or other implanted devices are advised not to use this feature.
- Being in an environment with a strong electromagnetic field will severely affect the quality of the ECG waveforms. Do not start a measurement when you are in such an environment.
- The feature isn't capable of detecting blood clots, strokes, heart failure, or other types of arrhythmia.
- This feature isn't capable of detecting heart attacks and related complications. Please seek timely medical assistance if you feel pain, tightness, or pressure in your chest, or experience any other symptoms.

Preparing for measurement

 To use this feature, download the latest version of the Huawei Health app from HUAWEI AppGallery and install it, or update the Huawei Health app to the latest version.

- 1** Registration and login: When logging in to the Huawei Health app for the first time, follow the onscreen instructions to register, and then enter your account name and password to log in.
- 2** Connecting to your device: After logging in to the Huawei Health app, follow the prompts to pair your device with the app.
- 3** Activating the app: If you are using **ECG** for the first time, go to **Health > Heart > ECG** in the Huawei Health app, and follow the onscreen instructions to activate the ECG app.

Measuring your ECG

- 1** Wear the device properly on your wrist, and select **ECG** from the app list. If you are using the feature for the first time, select which hand you are wearing the device on.
- 2** Place your arm flat on the table or your lap and relax your arm and fingers.
- 3** Keep a finger from your free hand on the electrode (Down button) of your watch to initiate a measurement.

- During the measurement, keep still and breathe evenly and steadily. Do not speak and do not release the electrode with your fingers. Ensure that the contact with the electrode is proper to avoid excessive pressing or insufficient contact.
- Dry skin can affect the quality of the measurement. If you notice that your finger is dry, wet it with a little bit of water to improve conductivity.

4 After the measurement is complete, the measurement result is displayed on the device screen. You can touch  to view the measurement result description. For details, open the Huawei Health app, and go to **Health > Heart > ECG**.

- Please consult with a medical professional about the measurement result. Do not interpret the result or take clinical measures by yourself.
- If the **sinus rhythm** icon is displayed, this may indicate that arrhythmia or other health problems were not detected. If you notice any changes in your health, promptly consult a medical professional.
- If the measurement result is --, it may be because that your finger has moved, skin is too dry, or the number of heartbeats per minute is greater than 110 or less than 50. In this case, it is recommended that you take a measurement again. If you are feeling uncomfortable, please seek medical assistance in a timely manner.

Measuring your skin temperature

Skin temperature measurements are mainly used to monitor the changes in the wrist skin temperature after exercise. After you enable a continuous skin temperature measurement, your skin temperature will be continuously measured and a measurement curve will be generated.

- The product is not a medical device. Temperature measurements are mainly used to monitor the changes in the wrist skin temperature of healthy people over the age of 18 during and after exercise. Results are for reference only and should not be used as a basis for medical diagnosis or treatment.
- During the measurement, wear the device relatively tightly for more than 10 minutes and stay in a relaxed environment at room temperature (about 25°C). Ensure that there are no water stains or alcohol on your wrist. Do not start a measurement in an environment with direct sunlight, wind, or cold/heat sources.
- After you exercise, shower, or switch between outdoor and indoor environments, wait 30 minutes before you start a measurement.

Single measurement

In the watch's app list, go to **Skin temperature > Measure** to start measuring your temperature.

Continuous measurement

- 1 Open the Health app, touch **Devices** and then the device name, go to **Health monitoring**, and enable **Continuous skin temperature measurement**.
- 2 In the watch's app list, touch **Skin temperature** to view the measurement curve.

Healthy Living

The Huawei Health app offers Healthy Living to help you develop healthy lifestyle habits and enjoy a healthy new life.

-  • Due to the different physical conditions of each individual, the health suggestions provided in Healthy Living, especially those related to physical activity, may not be applicable to all users, and may not be able to achieve the desired effect. If you feel uncomfortable during activities or workouts, please stop and take a rest or consult a doctor in a timely manner.
- The health suggestions provided in Healthy Living are for reference only. You shall bear all risks, damages, and liabilities arising from participating in any activities or workouts.

Enabling Healthy Living

- 1 Open the Huawei Health app, go to **Health > EDIT**, and add the **Healthy Living** card.
- 2 Touch the **Healthy Living** card, and follow the onscreen instructions to agree to the **User Notice**.

Selecting check-in tasks and setting goals

Check-in tasks are classified into basic check-in tasks and optional check-in tasks. You can add optional check-in tasks based on your needs.

On the Healthy Living screen, touch  in the upper right corner, select **Health plan**, select a check-in task, and touch **Goal settings** on the task card to set your daily goal.

Viewing the task completion status

- Enter the app list, and select **Healthy Living** to view the completion status of a specific task.
- Open the Huawei Health app and touch the **Healthy Living** card on the **Health** screen to view the task completion status.

Reminders

- 1 On the **Healthy Living** screen, touch  in the upper right corner, and select **Health plan**.
- 2 On the **health plan** screen, you can set general reminders or reminders for check-in tasks. That is, you can turn on the **Weekly report reminders on watch** switch or the **Reminders** switch for a specific task, for example, enabling **Reminders** for **Breath**.

Weekly report and sharing

Viewing a weekly report: On the **Healthy Living** screen, touch  in the upper right corner, and select **Weekly report** to view the report details.

Sharing: On the **Healthy Living** screen, touch the share icon in the upper right corner to share it to your WeChat friends, WeChat Moments, or Weibo, or save it to your device.

Disabling Healthy Living

On the **Healthy Living** screen, touch  in the upper right corner, and go to **About > Disable**. Once **Healthy Living** is disabled, all data of goals will be cleared.

Sleep monitoring

Recording sleep data on your wearable device

-  Ensure that you are wearing your device correctly. The device will automatically record the duration of your sleep, and identify whether you are in a deep sleep, a light sleep, or awake.
- Open the Huawei Health app, touch **Devices**, then your device name, go to **Health monitoring > HUAWEI TruSleep™**, and enable **HUAWEI TruSleep™**. When enabled, the device can accurately recognize when you fall asleep, when you wake up, and whether you are in a deep sleep, a light sleep, or REM sleep. The app can then provide you with sleep quality analysis, to help you understand your sleep patterns, and suggestions to help you improve the quality of your sleep.
- If **HUAWEI TruSleep™** has not been enabled, your device will track your sleep in the regular way. When you wear your device while sleeping, it will identify your sleep stages, and record the time that you fall asleep, wake up, and enter or exit each sleep stage, and it will then sync the data to the Huawei Health app.

Recording sleep data on your phone

- In the Huawei Health app, touch **Sleep monitoring** on the **Health** screen to enter the sleep monitoring screen. Alternatively, touch the **Sleep** card on the **Health** screen, and swipe to find and touch **Record your sleep**.
- Touch the settings icon in the upper right corner to edit your schedule and enable or disable general sleep settings, such as **Sleep sounds**.
- Touch **Go to sleep** and place your phone within 50 cm of your pillow. Your phone will then monitor and record your sleep data. Press and hold **Hold to end** for 3 seconds to exit sleep recording.
- Touch the icons at the bottom of the screen to select, play, turn off, and set a time for sleep music.

Productive nap

- Touch the **Sleep** card on the **Health** screen of the Huawei Health app, swipe to find and touch **Productive nap**. Touch the settings icon in the upper right corner to set an alarm or nap reminder.
- Swipe to select a break time and touch **START** to enable the alarm. Touch the icons at the bottom of the screen to select, play, turn off, and set a time for sleep music.

Viewing your sleep data

Touch the **Sleep** card on the **Health** screen of the Huawei Health app to view your daily, weekly, monthly, and yearly sleep data.

Measuring SpO2

-  To ensure the accuracy of the SpO2 measurement, wear the watch properly and ensure the strap is fastened. Ensure that the monitoring module is in direct contact with your skin without any obstructions.

Single SpO2 measurement

- 1 Wear your watch correctly and keep your arm still.
 - 2 From the home screen, press the Up button, swipe on the screen, and touch **SpO2**.
 - 3 For some products, touch **Measure**. The actual product prevails.
 - 4 Keep your body still during the SpO2 measurement.
-  The measurement will be interrupted if you swipe right on the watch screen, start a workout with the Health app, or receive a notification for an incoming call or alarm.
 - Data provided is for reference only and not for medical use. Consult a doctor as soon as possible if you feel uncomfortable.
 - During the SpO2 measurement, the watch will also measure your heart rate.
 - This measurement may also be affected by some external factors such as low blood perfusion, tattoos, a lot of hair on your arm, a dark complexion, lowering or moving your arm, or low ambient temperatures.

Automatic SpO2 measurements

- 1 Open the Huawei Health app, touch **Devices** and then your device name, touch **Health monitoring**, and enable **Automatic SpO2 measurement**. The device will then automatically measure and record your SpO2 when it detects that you are still.
- 2 Touch **Low SpO2 alert** to set the lower limit of your SpO2 for you to receive an alert when you are not asleep.

Measuring your heart rate

- To guarantee a more accurate heart rate measurement, wear the watch correctly and ensure the strap is fastened. Make sure that your watch is secure on your wrist. Ensure that the monitoring module is in direct contact with your skin without any obstructions.

Individual heart rate measurement

1 Open the Huawei Health app, touch **Devices** then your device name, go to **Health monitoring > Continuous heart rate monitoring**, and disable **Continuous heart rate monitoring**.

2 Access the app list and select **Heart rate** to measure your heart rate.

- This measurement may also be affected by some external factors such as low blood perfusion, tattoos, a lot of hair on your arm, a dark complexion, lowering or moving your arm, or low ambient temperatures.

Heart rate measurement for a workout

During a workout, the device displays your real-time heart rate and heart rate zone, and notifies you when your heart rate exceeds the upper limit. For better training results, you are advised to do a workout based on your heart rate zone.

- Heart rate zones can be calculated based on the maximum heart rate percentage or HRR percentage. To choose the calculation method, open the Health app, go to **Me > Settings > Workout settings > Exercise heart rate settings** and set **Calculation method** to either **Maximum heart rate percentage** or **HRR percentage**.

- If you select **Maximum heart rate percentage** as the calculation method, the heart rate zone for different types of workout activities (Extreme, Anaerobic, Aerobic, Fat-burning, and Warm-up) is calculated based on your maximum heart rate ("220 minus your age" by default).
 - If you select **HRR percentage** as the calculation method, the heart rate interval for different types of workout activities (Advanced anaerobic, Basic anaerobic, Lactic acid, Advanced aerobic, and Basic aerobic) is calculated based on your heart rate reserve ("HRmax minus HRrest").
- Heart rate measurement during a workout: The real-time heart rate can be displayed on the device when you start a workout.
 - After completing your workout, you can check your average heart rate, maximum heart rate, and heart rate zone on the workout results screen.
 - Your heart rate will not be displayed if you remove the device from your wrist during the workout. However, it will continue to search for your heart rate signal for a while. The measurement will resume once you put the device back on.

Continuous heart rate monitoring

Open the Huawei Health app, touch **Devices** then your device name, go to **Health monitoring > Continuous heart rate monitoring**, and enable **Continuous heart rate monitoring**. Once this feature is enabled, your watch can measure your real-time heart rate.

Resting heart rate measurement

Resting heart rate refers to your heartbeats per minute measured when you are awake, still, and calm. It is an important indicator of your heart health. The best time to measure your resting heart rate is immediately after you wake up in the morning.

Open the Huawei Health app, touch **Devices** then your device name, go to **Health monitoring > Continuous heart rate monitoring**, and enable **Continuous heart rate monitoring**. The device will then measure your resting heart rate automatically.

-  • If you disable **Continuous heart rate monitoring** after checking your resting heart rate, the resting heart rate displayed in the Health app will remain the same.
- The resting heart rate data on the device will be cleared on its own at 00:00 (24-hour clock) or 12:00 midnight (12-hour clock).

Heart rate limit warning

After you start a workout using your watch, your watch will vibrate to alert you that your heart rate value has exceeded the upper limit for more than 60 seconds.

Perform the following to set a **heart rate upper limit**:

Open the Huawei Health app, go to **Me > Settings > Workout settings > Exercise heart rate settings**, touch **Heart rate limit**, and set an upper limit.

Heart rate alerts

High heart rate alert

Touch **Devices** and your device name, go to **Health monitoring > Continuous heart rate monitoring**, turn on the switch for **Continuous heart rate monitoring**, and set a high heart rate alert. You will then receive an alert when you are not doing a workout and your heart rate stays above your set limit for more than 10 minutes.

Low heart rate alert

Touch **Devices** and your device name, go to **Health monitoring > Continuous heart rate monitoring**, turn on the switch for **Continuous heart rate monitoring**, and set a low heart rate alert. You will then receive an alert when you are not doing a workout and your heart rate stays below your set limit for more than 10 minutes.

Stress test

Testing your stress levels

Wear the device correctly and keep your body still during the stress test.

- **Single stress test:**
Open the Huawei Health app, touch the **Stress** card, and touch **Stress test** to start a single stress test. Touch **Calibrate stress level** and follow the onscreen instructions to calibrate the stress level.
 - **Periodic stress test:**
Open the Huawei Health app, touch **Devices** and then your device name, go to **Health monitoring > Automatic stress test**, turn on the switch for **Automatic stress test**, and follow the onscreen instructions to calibrate the stress level. Periodic stress tests will then start automatically when you wear the watch correctly.
-  The accuracy of the stress test may be affected if the user has just taken substances with caffeine, nicotine, or alcohol, or psychoactive drugs. It may also be affected when the user suffers from heart disease or asthma, has been exercising, or is wearing the watch incorrectly.

Viewing stress data

- **On the device:**
Press the Up button to access the device's app list, and touch **Stress** to view your daily stress change, including the stress bar chart and level in a single day.
- **In the Huawei Health app:**
Open the Huawei Health app, then touch the **Stress** card to view your latest stress scores and level, daily, weekly, monthly, and yearly stress curves, and corresponding advice.

Activity reminder

When **Activity reminder** is enabled, the device will monitor your activity throughout the day in increments (one hour by default). It will vibrate and the screen will turn on to remind you to take a moment to get up and move around if you didn't move around during the set period.

Open the Huawei Health app, go to the device details screen, touch **Health monitoring**, and enable **Activity reminder**.

-  The device will not vibrate to remind you to move around if you have enabled **Do Not Disturb** on it.
- The device will not vibrate if it detects that you are asleep.
- The device will only send reminders between 8:00 and 12:00 and between 14:30 and 21:00.

Menstrual cycle predictions

The device can predict your next period and fertile window based on data from your periods.

- **Method 1:**

- 1 Open the Huawei Health app, touch **Cycle Calendar**, and grant the corresponding permissions. If you are unable to find the **Cycle Calendar** card on the home screen, touch **EDIT** on the home screen to add this card to the home screen.
- 2 Press the side button on the watch's home screen, touch **Cycle Calendar**, and then touch  to set the start and end of your periods. After you finish, your watch will predict your next period based on the data you recorded.

• **Method 2:**

- 1 Open the Huawei Health app, touch **Cycle Calendar**, and grant the corresponding permissions. If you are unable to find the **Cycle Calendar** card on the home screen, touch **EDIT** on the home screen to add this card to the home screen.
- 2 Touch **Record period** on the **Cycle Calendar** screen. You can then select **Period started** or **Period ended?** for specific dates to record the duration of your period. You can also record your physical condition in **Record symptoms**.
- 3 Touch  in the lower right corner, select **Wearable device reminders**, and turn on all reminder switches. The device will send you reminders for the start and end of your period and fertile window.

You can also select **Edit period** to set **Period length** and **Cycle length**.

-  • When pairing with iOS phones/tablets, Cycle Calendar is not supported if the card for it is not displayed.
- Touch Records to view and modify the period data. The predicted period is marked by the dotted line.
- The device will remind you about the start of your period before 8:00 AM on the day before it's supposed to start. You will be reminded about all other reminders for the day of the event at 8:00 AM on that day.

Assistant

HUAWEI Assistant·TODAY

The HUAWEI Assistant·TODAY screen makes it easy to view weather forecast, wake up the voice assistant, access apps that have been opened, and view push messages from the calendar and AI Tips.

Entering/Exiting HUAWEI Assistant·TODAY

Swipe right on the watch home screen to enter HUAWEI Assistant·TODAY. Swipe left on the screen to exit HUAWEI Assistant·TODAY.

Audio control center

You can use the HUAWEI Music card on the HUAWEI Assistant·TODAY screen to control music playback on both your phone and watch. To control music playback on your phone via the watch, you'll need to pair the watch with the Huawei Health app.

 This feature is not supported when your device is paired with an iPhone.

Apps

 This feature is not supported for iOS phones/tablets.

Installing apps

- 1 Open the Huawei Health app, touch **Devices** and your device name, then touch **AppGallery**.
- 2 Select the app you want to use from the **Apps** list and touch **Install**. After the app is installed, it will be displayed in the app list on your device.

Using apps

Swipe up or down on the app list of your device, select an app, and follow the onscreen instructions to use it.

-  Some apps can only be used when the device is connected to your phone. If the device displays a message asking you to install the app on your phone, it indicates that the app can only be used with your phone.
- When you install and use an app on your phone for the first time, agree to the agreements or terms displayed on the app screen, and follow the onscreen instructions to complete giving authorization and logging in. Otherwise, you will not be able to use the app. If there is an issue when granting authorization, open the Huawei Health app, go to **Me > Settings > Device capabilities**, and select the app that you want to grant authorization to again.

Updating apps

- 1 Open the Huawei Health app, touch **Devices** and your device name, then touch **AppGallery**.
- 2 Touch **Manager** to view the apps to be updated and the list of installed apps.
- 3 Go to **Updates > Update** to update apps to the latest version for a better experience.

Uninstalling apps

- 1 Open the Huawei Health app, touch **Devices** and your device name, then touch **AppGallery**.
 - 2 Touch **Manager** to view the apps to be updated and the list of installed apps.
 - 3 Go to **Installation manager > Uninstall** to uninstall apps. After the app is uninstalled, it will also be deleted from your device.
- i** If you touch **Disable AppGallery service** and **DISABLE** in the Huawei Health app, **AppGallery** will be disabled. If you want to use this feature again, touch **AppGallery** and follow the onscreen instructions to complete authorization, and enable **AppGallery**.

Message management

When the Huawei Health app is connected to your device, and the message notifications are enabled, messages pushed to the status bar of your phone/tablet can be synced to your device.

Enabling message notifications

- 1 Open the Huawei Health app, touch **Devices** and then your device name, touch **Notifications**, and turn on the switch.
 - 2 Go to the app list and turn on the switches for apps that you want to receive notifications from.
- i** You can go to **Apps** to view the apps that you can receive notifications from.

Viewing unread messages

Your device will vibrate to notify you of new messages pushed from the status bar of your phone/tablet.

Unread messages can be viewed on your device. To view them, swipe up on the home screen to enter the unread message center.

Replying to messages

- i** This feature is not supported for iOS phones/tablets.

When receiving a message from WhatsApp, Messenger, or Telegram on your watch, you can use quick replies or emoticons to reply to it. The supported message types are subject to the actual situation.

Customizing quick replies

 This feature is not supported for iOS phones/tablets.

You can customize a quick reply as follows:

- 1 Connect your device to the Huawei Health app, open the devices details screen, and touch the **Quick replies** card.
- 2 You can touch **Add reply** to add a reply, touch an added reply to edit it, and touch  next to a reply to delete it.

Deleting unread messages

Touch **Clear** or  at the bottom of the message list to clear all unread messages.

Rejecting incoming calls

When there is an incoming call, your watch will inform you and display the caller's number or name. You can reject the call.

- Press the Up button to stop the watch from vibrating during an incoming call.
- Touch the End icon on the screen or touch and hold the Up button on your watch to end the call.

Viewing call logs

Viewing your call logs

Press the Up button on your device to access the app list, swipe up or down until you find **Call log**, and touch it to view call logs (including incoming, outgoing, and missed calls) on your device.

Calling back

When your device is paired with your phone, touch any call record to call back.

Deleting call logs

Swipe down to the bottom of the screen and touch **Clear** or  to clear all call logs.

Controlling music playback

-  • To use this feature, ensure that your watch is connected to the Huawei Health app.
 - This feature is not supported when your watch is paired with an iPhone.

Adding music to your watch



- 1 Open the Huawei Health app and go to the device details screen.

- 2 Go to **Music > Manage music > Add songs** and select the music to be added.
- 3 Click ✓ in the upper right corner of the screen.
When adding music, you can also create a playlist by touching **New playlist**. After you have created a playlist, you can add your preferred music that has been uploaded to your watch to the playlist for easy management.

Controlling music playback on your device

- 1 Go to the app list of your device, select **Music**, or go to **Music > Playing music**.
- 2 Touch the play button to play the song.
- 3 On the music playback screen, you can swipe up on the screen to view the playlist, switch between songs, adjust the volume, and set the playback sequence (for example, play songs in sequence or randomly).

Controlling music playback on your phone

- Open the Huawei Health app, go to the device details screen, touch **Music**, and turn on **Control phone music**.
- Open the Music app on your phone and play music.
- You can use the following methods to access the music playback screen and pause, switch between songs on your phone, adjust the music volume on your phone, and more.
For watches that support HUAWEI Assistant-TODAY: Swipe right on the home screen of your watch. On the HUAWEI Assistant-TODAY screen, touch the music card with the phone icon.
For watches that do not support HUAWEI Assistant-TODAY: Open the **Music** app on your watch, touch  or , and select **Phone**.

Flashlight

On the device, enter the app list and touch **Flashlight**. The screen will light up. Touch the screen to turn off the flashlight, then touch the screen again to turn it back on. Swipe right on the screen or press the side button to close the Flashlight app.

-  The flashlight turns on for 5 minutes by default.



Compass

The **Compass** app displays the direction of your watch, helping you get your bearings in unfamiliar environments such as when you are outdoors or traveling.

Touch **Compass** in the app list and follow the onscreen instructions to calibrate your watch. After the calibration is complete, your watch will display a compass dial.

-  During the calibration, avoid sources of magnetic field interference, such as phones, tablets, and computers, as they might affect the calibration accuracy.

Remote shutter

After the watch is connected to your phone/tablet, touch **Remote shutter** in the app list on your watch to enable the camera on your phone/tablet, and then you can touch  on the watch screen to take a photo. Touch  or  to switch between a 2-second and 5-second timer.

-  After your watch is paired with your phone/tablet, if Remote shutter is displayed in the app list on your watch, it indicates that this feature is supported. Otherwise, this feature is not supported.
- To use this feature, ensure that your watch is connected to your phone/tablet and that the Huawei Health app is running in the background.

Voice assistant

The wearable device allows you to use the voice assistant to check for information, and control smart home devices once it is connected to the Huawei Health app on your phone.

-  To ensure that the voice assistant will work, update your watch to the latest version. This feature is supported only when your device is paired with a HUAWEI phone. Currently, this feature is only supported in certain countries and regions.

Using the voice assistant

- 1 Press and hold the Down button to wake up the voice assistant.
- 2 Give a voice command on the displayed screen, such as "What's the weather like today?".

More

Adjusting and changing the strap

Adjusting the strap

Three-bead metal strap:

- 1 To remove the strap, push the lever in the direction indicated by arrow 1 and then remove the link in the direction indicated by arrow 2.

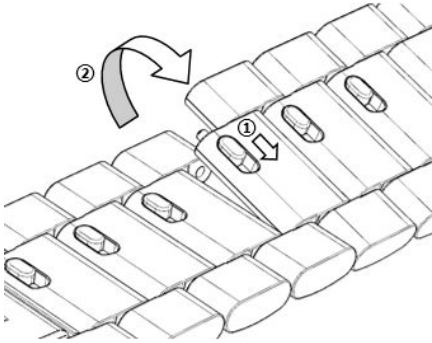

- 2 To install a strap, push the lever in the direction indicated by arrow 1 and then install the link in the direction indicated by arrow 2.

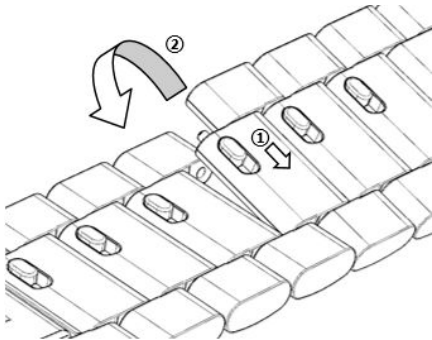

Ceramic strap:

- a To remove the strap: Use a screwdriver to rotate and remove the screw in the counter-clockwise direction, eject the bolt on the other side, and remove the link.

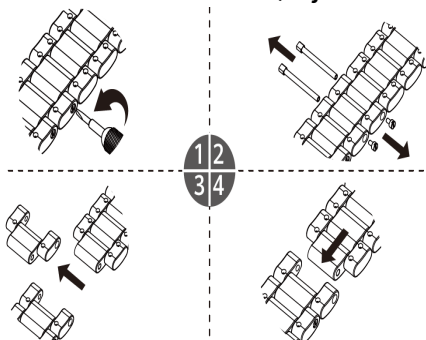

- b To install a strap, insert the bolt into one side of the hole, and the screw into the other side, and use a screwdriver to rotate the screw in the clockwise direction to install the link.

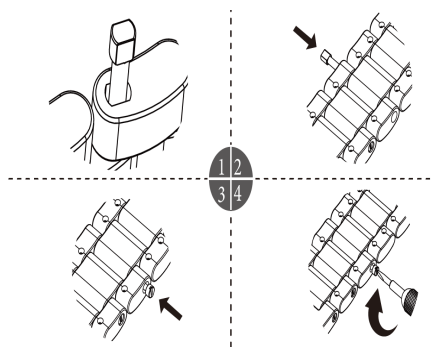

Changing the strap

- If you are using a non-metal strap, perform the following steps to remove it and install a new strap in the reverse order.

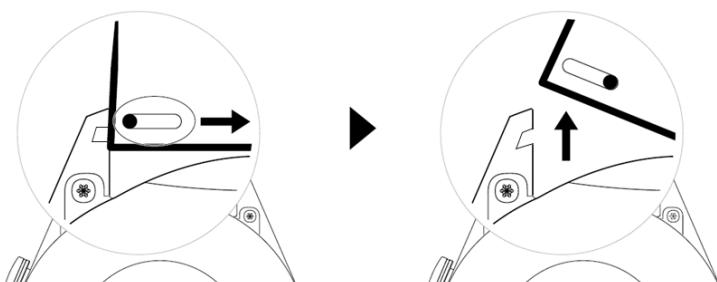

- To remove and install a metal strap, perform the following steps:

- Removal:

- Watch case with one guide slot on a lug:

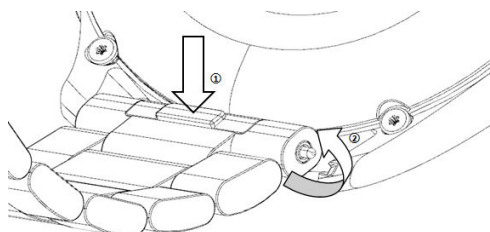

- Watch case with two guide slots on a lug:

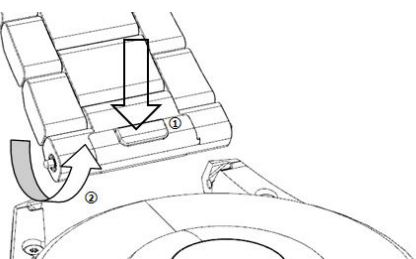

- Installation:

- If the watch case has one guide slot on a lug, insert the left spring bar of the watch strap into the bar hole on the watch case and then press the right spring bar through the guide slot.
- If the watch case has two guide slots on a lug, press the left and right spring bars of the watch strap through the two guide slots.

- Fastening the watch buckle

Press the middle position of the buckle against a lug.

- The leather strap is not waterproof. Please keep it dry and remove any sweat and other liquids in a timely manner.

Configuring Gallery watch faces

- Before using this feature, update the Huawei Health app and your device to their latest versions.

Selecting Gallery watch faces

1. Open the Huawei Health app, touch **Devices** and then your device name, and go to **Watch faces > More > Mine > On watch > Gallery** to access the Gallery settings screen.
2. Touch + and select either **Camera** or **Gallery** as the method for uploading an image.
3. Touch ✓ in the upper right corner, and then touch **Save**. Your watch will then display the selected image as the watch face.

Other settings

On the Gallery settings screen:

- Touch **Style**, **Position**, and **Function** to set the style, location of the date and time and functions on the Gallery watch faces.
- Touch the Cross icon in the upper right corner of a selected photo to delete it.

Setting the AOD watch face

You can enable the Always on display (AOD) feature and select to display the main watch face or AOD watch face when you raise your wrist.

- Enabling AOD will reduce the battery life.
 - After you enable AOD, the Raise to wake feature will be disabled.



Setting AOD

- 1 Open the app list, go to **Settings > Watch face & home** or **Settings > Watch face**, and enable AOD.
- 2 Go to **AOD style > Default style** and select your preferred style. The style will then be displayed when the main watch face doesn't come with a built-in AOD watch face and you raise your wrist.

Managing watch faces

Watch Face Store provides a diverse range of watch faces for you to choose from. To use this feature, update your watch and the Huawei Health app to their latest versions.



Changing a watch face on your watch

- 1 Touch and hold the watch face screen or go to **Settings > Watch face & launcher > Watch faces**.
- 2 Swipe left or right to select a watch face you like.
 -  Some watch faces support custom control. You can touch  at the bottom of the watch face to customize the content that is displayed.

Installing and changing the watch face on your phone

- 1 Open the Huawei Health app, touch **Devices** and the device name, and go to **Watch faces > More**.
- 2 Select a watch face.
 - a If the watch face has not been installed, touch **Install**. After the installation is complete, your watch will automatically use this new watch face.
 - b If the watch face has been installed, touch **SET AS DEFAULT** to use the selected watch face.
 -  . Paid watch faces cannot be refunded. If you cannot find watch faces in Watch Face Store that you have already purchased, contact the customer service hotline.

Deleting a watch face

- 1 Open the Huawei Health app, touch **Devices** and the device name, and go to **Watch faces > More**.
- 2 Select an installed watch face and touch  to delete it.
 -  . Gallery or video watch faces cannot be deleted.
 - You do not need to purchase a watch face again after deleting it from Watch Face Store. You will only need to reinstall it.

Setting favorite contacts

- 1 Open the Huawei Health app, touch **Devices** and your device name, then select **Favorite contacts**.
- 2 On the **Favorite contacts** screen:
 - Touch **ADD** to display your phone/tablet's contacts list and then select the contacts you wish to add.
 - Touch **Sequence** to sort the contacts you have added.
 - Touch **Remove** to remove a contact you have added.
- 3 Touch a favorite contact from **Favorite contacts** in your watch's app list to call the contact's number on your watch.

Setting the time and language



After you have synced data between your device and phone/tablet, the system language will be synced to your device as well.

If you change the language, region, or time on your phone/tablet, the changes will automatically sync to the device as long as it is connected to your phone/tablet via Bluetooth.

Customizing the function of the Down button

- 1 Press the Up button to open the app list and then go to **Settings > Down button**.
- 2 Select an app and customize the function of the Down button.
After you have finished customizing the function, return to the home screen and press the Down button to open the current app.

Adding custom cards

- 1 Go to **Settings > Custom cards** or **Settings > Display > Favorites**.
- 2 Touch , and select the cards to be displayed, such as the **Sleep**, **Stress**, and **Heart rate** cards. The actual display prevails.
- 3 Touch  next to a card that you have added, or touch and hold the card to move it to another position (supported on some device models). Touch  to delete the card.
- 4 After the settings are complete, swipe left or right on the home screen to view the added cards.

Adjusting the screen brightness

- 1 Access the app list on your device, and go to **Settings > Display & brightness** or **Settings > Display**.
- 2 If **Automatic** is enabled, disable it.
- 3 Touch **Brightness** to adjust the screen brightness.

Update

Open the Health app, touch **Devices** and your device name, then touch **Firmware update**. Your phone will check for any available updates. Follow the onscreen instructions to update your device.

- **i** • Once **Auto-update device over Wi-Fi** or **Auto-download update packages over Wi-Fi** is enabled, your device will receive an update package and send you a notification about the update. Follow the onscreen instructions to update your device.
- You are advised to ensure that your device has sufficient power before the update.
- During an update, Bluetooth on your device will automatically disconnect, and reconnect once the update is complete.
- Do not charge your device during the update.

Powering on, powering off, and restarting your watch

Powering on

- Press and hold the Up button.
- Charge the device.

Powering off

- Press and hold the Up button, and then touch **Power off**.
- Press the Up button and go to **Settings > System > Power off** or **Settings > System & updates > Power off**

Restarting

- Press and hold the Up button, and then touch **Restart**.
- Press the Up button and go to **Settings > System > Restart** or **Settings > System & updates > Restart**.