

Panasonic®

Operating Instructions and Cookbook Microwave/Grill Oven

Model No. NN-GD38HS

For domestic use only



INVERTER

**Important safety instructions
Please read carefully and keep for future reference**

Important Notice

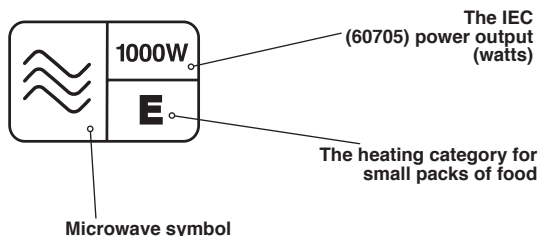

Thank you for purchasing a Panasonic Microwave Oven.

Your oven is rated 1000 Watts (IEC). When using other cookbooks remember to adjust cooking times accordingly. The symbol above, which is displayed on your oven door, indicates the heating category for your oven when cooking or reheating convenience foods.

Your oven is rated 'E', which is very efficient. It is therefore very important that you refer carefully to the packet instructions on convenience foods.

Some packet instructions only display information for B or D rated ovens. We therefore provide additional guidelines for reheating and cooking on page **41-47** of this book.

Always check the progress of the food as it cooks or reheats by simply opening the door. After checking the progress of the foods, press **Start** to continue the cooking time.

Failure to follow the instructions given in this Operating Instructions and Cookbook, may affect the recipe result and in some instances may be dangerous.



Customer Communications Centre 0344 844 3899

Selected Spares and Accessories:

Order direct on line at www.panasonic.co.uk or by telephoning the Customer Communications Centre number above.

For Cookery Advice call: 01344 862108 (open Monday to Wednesday 9am - 12pm)
Alternatively visit our web site at www.theideaskitchen.co.uk

Thank you for purchasing this Panasonic appliance.

Contents

Safety Instructions	4-9	Grilling	31
Disposal of Waste Products	10	Combination Cooking	32
Before Using Your Oven	11	Using the Timer	33
Placement of Your Oven	11	Multistage Cooking	34
Care & Cleaning of Your Oven	12-13	Auto Cook/Combi Programs	35-37
Maintenance of Your Oven	13	Chaos Defrost	38-39
Parts of Your Oven	14-15	Cooking and Reheating Guidelines	40
Important Information	16-18	Reheating Charts	41-43
Microwaving Principles	19	Cooking Charts	44-47
Control Panel	20	Recipes	
General Guidelines	21-22	Soups and Snacks	48
Containers to Use	23-24	Meat and Poultry	49-50
Setting the Clock	25	Fish	51
Child Lock	25	Vegetables	52
Microwave Cooking and Defrosting	26	Desserts/Cakes	53-54
Defrosting Guidelines	27	Sauces/Jam	55
Defrosting Chart	28	Questions and Answers	56
Using the Quick 30 Function	29	Technical Specifications	57
Using the Add Time Function	30		

Safety Instructions

- Important safety instructions. Before operating this oven, please read these instructions carefully and keep for future reference.
- This appliance can be used by children aged from 8 years and above and persons with reduced physical, sensory and mental capabilities or lack of experience and knowledge if they have been given supervision or instruction by a person responsible for their safety concerning the use of the appliance in a safe way and understand the hazards involved. Children shall not play with the appliance. Cleaning and user maintenance shall not be made by children without supervision. Keep the appliance and its cord out of reach of children less than 8 years.
- When this oven is installed, it should be easy to isolate the appliance from the electricity supply by pulling out the plug or operating a circuit breaker.
- If the supply cord is damaged, it must be replaced by the manufacturer or its service agent or a similarly qualified person in order to avoid a hazard.
- Warning! The appliance should be inspected for damage to the door seals and door seal areas and if these areas are damaged the appliance should not be operated until it has been repaired by a service technician trained by the manufacturer.

Safety Instructions

- **Warning!** Do not attempt to tamper with or make any adjustments or repairs to the door, control panel housing, safety interlock switches or any other part of the oven. Do not remove the outer panel from the oven which gives protection against exposure to microwave energy. Repairs should only be by a qualified service person.
- Liquids and other foods must not be heated in sealed containers since they are liable to explode.
- **Warning!** Do not place this oven near an electric or gas cooker range.
- **Warning!** Only allow children to use the oven without supervision when adequate instructions have been given so that the child is able to use the oven in a safe way and understands the hazards of improper use.
- This oven is intended for Counter-top use only. It is not intended for built-in use or for use inside a cupboard.

For Countertop Use:

- Oven must be placed on a flat, stable surface 85 cm / 33 ½" above floor level. For proper operation, the oven must have sufficient air flow. i.e. 5 cm /2" at one side, the other being open; 15 cm /6" clear over the top; 10 cm /4" at the rear.
- When heating food in plastic or paper containers, check the oven frequently as these types of containers ignite if overheated.
- If smoke is emitted or a fire occurs in the oven, press Stop/Cancel button and leave the door closed in order to stifle any flames. Disconnect the power cord, or shut off power at fuse or circuit breaker panel.

Safety Instructions

- This appliance is intended to be used in household applications only.
- Microwave heating of beverages can result in delayed eruptive boiling, therefore care must be taken when handling the container.
- The contents of feeding bottles and baby food jars are to be stirred or shaken. The temperature has to be checked before consumption to avoid burns.
- Do not cook eggs in their shells and whole hard-boiled eggs by **microwave**. Pressure may build up and the eggs may explode, even after the microwave heating has ended.
- Clean the inside of the oven, door seals and door seal areas regularly. When food splatters or spilled liquids adhere to the oven walls, door seals and door seal areas wipe off with a damp cloth. Mild detergent may be used if they get very dirty. The use of harsh detergent or abrasive is not recommended. **Do not use commercial oven cleaners.**
- When using the **grill** or **combination** mode, some foods may inevitably splatter grease on to the oven walls. If the oven is not cleaned occasionally, it may start to “smoke” during use.
- Failure to maintain the oven in a clean condition could lead to deterioration of surfaces that could affect the life of the appliance and possibly result in a hazardous situation.
- A steam cleaner is not to be used for cleaning the appliance.

Safety Instructions

- Warning! The accessible parts may become hot in grill and combination use. Young children should be kept away. Children should only use the oven under adult supervision due to the temperatures generated.
- Exterior oven surfaces, including air vents on the cabinet and the oven door will get hot during **combination** and **grilling**, take care when opening or closing the door and when inserting or removing food and accessories.
- The oven has two grill heaters situated in the top of the oven. After using either the grill or combination functions, the inside surfaces of the oven will be very hot. Care should be taken to avoid touching any of the inside surfaces near the heating element inside the oven. **N.B. After cooking by these modes, the oven accessories will be very hot.**
- This appliance is not intended to be operated by means of an external timer or separate remote-control system.
- In case of electronic failure, oven can only be turned off at wall socket.
- Only use utensils that are suitable for use in microwave ovens.
- Do not use harsh, abrasive cleaners or sharp metal scrapers to clean the oven door glass since they can scratch the surface, which may result in shattering of the glass.

Safety Instructions

- This combination oven is intended for heating food and beverages only. Take care when heating foods low in moisture, e.g. bread items, chocolate, biscuits and pastries. These can easily burn, dry out or catch on fire if cooked too long. We do not recommend heating foods low in moisture such as popcorn or poppadoms.
- Drying of food, newspapers or clothing and heating of warming pads, slippers, sponges, damp cloths, wheat bags, hot water bottles and similar may lead to risk of injury, ignition or fire.
- The oven lamp must be replaced by a service technician trained by the manufacturer. **Do not** attempt to remove the outer casing from the oven.
- Caution! In order to avoid a hazard due to inadvertent resetting of the thermal cut-out, this appliance must not be supplied through an external switching device, such as a timer, or connected to a circuit that is regularly switched on and off by the utility.



Safety Instructions

Read carefully and keep for future reference.

This appliance is supplied with a moulded three pin mains plug for your safety and convenience, which may be marked, and rated, 10 amps.

A 10 amp fuse is fitted according to the type of mains plug fitted.

Should the fuse need to be replaced, please ensure that the replacement fuse has the correct rating for the type of mains plug fitted and that it is approved by ASTA or BSI to BSI362.

Check for the ASTA mark  or the BSI mark  on the body of the fuse.



Warning!

If the fuse cover is detachable, never use the plug with the cover omitted. A replacement fuse cover can be purchased from your local Panasonic Dealer.

How to replace the fuse

Open the fuse compartment with a screwdriver and replace the fuse.

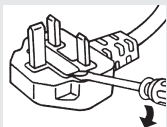

If the fitted moulded plug is unsuitable for the socket outlet in your home then the fuse should be removed and the plug cut off and disposed of safely and an appropriate one fitted. There is a danger of severe electrical shock if the cut off plug is inserted into any 10 amp socket.

If a new plug is to be fitted, please observe the wiring code as shown opposite. If in any doubt, please consult a qualified electrician (For U.K. Models only).



Warning!

This appliance must be earthed.



Important!

The wires in this mains lead are coloured in accordance with the following code: Green-and-yellow: Earth. Blue: Neutral. Brown: Live.

As the colours of the wire in the mains lead of this appliance may not correspond with the coloured markings identifying the terminals in your plug, proceed as follows:

The wire which is coloured **green-and-yellow** must be connected to the terminal in the plug which is marked with the letter **E** or by the Earth symbol  or coloured **green** or **green-and-yellow**.

The wire which is coloured **blue** must be connected to the terminal in the plug which is marked with the letter **N** or coloured **black**.

The wire which is coloured **brown** must be connected to the terminal in the plug which is marked with the letter **L** or coloured **red**.

When this oven is installed it should be easy to isolate the appliance from the electricity supply by pulling out the plug or operating a circuit breaker.



Voltage & Power

The voltage used must be the same as specified on this microwave oven. Using a higher voltage than that which is specified is dangerous and may result in a fire or other type of accident causing damage.

Do not immerse cord, plug or oven in water. Keep cord away from heated surfaces. Do not let cord hang over the edge of table or work top. Do not plug your oven in via an extension cable as this can be dangerous. It is important to plug the oven directly into a wall socket.

The back of the appliance heats up during use. Do not allow the cord to be in contact with the back of the appliance or cabinet surface.

Disposal of Waste Products

Information on Disposal for Users of Waste Electrical & Electronic Equipment (Private Households).



This symbol on the products and/or accompanying documents means that used electrical and electronic products should not be mixed with general household waste.

For proper treatment, recovery and recycling, please take these products to designated collection points, where they will be accepted on a free of charge basis. Alternatively, in some countries you may be able to return your products to your local retailer upon the purchase of an equivalent new product.

Disposing of this product correctly will help to save valuable resources and prevent any potential negative effects on human health and the environment which could otherwise arise from inappropriate waste handling. Please contact your local authority for further details of your nearest designated collection point.

Penalties may be applicable for incorrect disposal of this waste, in accordance with national legislation.

For Business Users in the European Union

If you wish to discard electrical and electronic equipment, please contact your dealer or supplier for further information.

Information on Disposal in Other Countries Outside the European Union

This symbol is only valid in the European Union.

If you wish to discard this product, please contact your local authorities or dealer and ask for the correct method of disposal.

Before Using Your Oven

Examine your Oven

1. Unpack oven, remove all packing material, and examine the oven for any damage such as dents, broken door latches or cracks in the door. Notify dealer immediately if unit is damaged. Do **not** install if unit is damaged.

Guarantee

2. Your receipt is your guarantee, please keep safely.

Cord

3. If the supply cord of this appliance is damaged, it must be replaced by the manufacturer or it's service agent or a similarly qualified person in order to avoid a hazard.



Note

The appliance should be inspected for damage to the door seals and door seal areas. If these areas are damaged the appliance should not be operated until it has been repaired by a service technician trained by the manufacturer.

4. Before using combination or grill function for the first time operate the oven without food and accessories (including glass turntable and roller ring) on **grill 1** for 5 minutes. This will allow the oil that is used for rust protection to be burned off. This is the only time that the oven is operated empty. **Caution: All inside surfaces of the oven will be hot.**



Caution! Hot surfaces

Placement of Your Oven

This oven is intended for counter-top use only. It is not intended for built-in use or for use inside a cupboard.

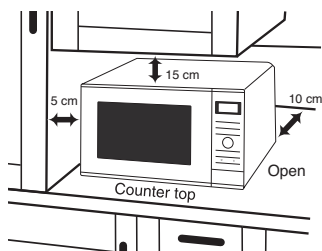

1. Oven must be placed on a flat, stable surface 85 cm / 33 1/2" above floor level. For proper operation, the oven must have sufficient air flow, i.e. 5 cm / 2" at one side, the other being open; 15 cm / 6" clear over the top; 10 cm / 4" at the rear.
2. Do not place the microwave oven on a shelf directly above a gas or electric hob. This may be a safety hazard and the oven may be damaged.
3. Do not block the air vents on the sides and back of the oven. If these openings are blocked during operation the oven may overheat. In this case the oven is protected by a thermal safety device and resumes operation only after cooling down. The oven will remain inoperable with a blank display until it has cooled.
4. This appliance is intended to be used in household applications only.

Care & Cleaning of Your Oven



Important

It is essential for the safe operation of the oven that it is kept clean and wiped out after each use. Failure to maintain the oven in a clean condition could lead to deterioration of a surface that could adversely affect the life of the appliance and possibly result in a hazardous situation.

1. **Switch the oven off before cleaning** and unplug at socket if possible.
2. **Keep the inside of the oven, door seals and door seal areas clean**
When food splatters or spilled liquids adhere to oven walls, door seals and door seal areas wipe off with a damp cloth. Mild detergent may be used if they get very dirty. The use of harsh detergent or abrasives is not recommended. Take care when cleaning around the waveguide cover.
3. After using **grill and combination** cooking the walls of the oven should be cleaned with a soft cloth and soapy water. Particular care should be taken to keep the window area clean especially after cooking by **grill and combination**. Stubborn spots inside the oven can be removed by using a small amount of conventional oven-cleaner sprayed onto a soft damp cloth. Wipe onto problem spots, leave for recommended time and then wipe off. **Do not spray directly inside the oven.**
4. After use, the **oven interior** should be wiped out to remove any remaining water in order to reduce the risk of corrosion to the cavity and door. The cavity and door can be damaged by abrasive cleaners and sharp objects so care must be taken to avoid damage caused in this way. If the cavity or door become damaged the lining may begin to corrode. Providing the above precautions are taken regarding the cleaning and care of your oven the life of the cavity and door may be extended.
5. The **outside oven surface** should be cleaned with a damp cloth. To prevent damage to the operating parts inside the oven, water should not be allowed to seep into the ventilation openings.
6. If the **control panel** becomes dirty, clean with a soft, dry cloth. Do not use harsh detergents or abrasives on the control panel. When cleaning the control panel, leave the oven door open to prevent the oven from accidentally turning on. After cleaning press **Stop/Cancel** button to clear display window.
7. Do not use harsh abrasive cleaners or sharp metal scrapers to clean the **oven door glass** since they can scratch the surface, which may result in shattering of the glass.
8. **Keep air vents clear at all times**
Check that no dust or other material is blocking any of the air vents on the top, bottom or rear of the oven. If air vents become blocked this could cause overheating which would affect the operation of the oven and possibly result in a hazardous situation.
9. **If steam accumulates** inside or around the outside of the oven door, wipe with a soft cloth. This may occur when the microwave oven is operated under high humidity conditions and in no way indicates a malfunction of the unit or microwave leakage.
10. It is occasionally necessary to remove the **glass turntable** for cleaning. Wash the turntable in warm soapy water. Do not place in the dishwasher.

Care & Cleaning of Your Oven

11. The **roller ring and oven cavity floor** should be cleaned regularly to avoid excessive noise. Simply wipe the bottom surface of the oven, particularly the turntable spindle and the area surrounding this, with mild detergent and hot water then dry with a clean cloth. The roller ring may be washed in mild soapy water.

After removing the roller ring from cavity floor for cleaning, be sure to replace it in the proper position.
12. **When grilling or cooking by combination**, some foods may splatter grease onto the oven walls. If the oven is not cleaned to eliminate this grease, it can accumulate and cause the oven to 'smoke' during use. These marks will be more difficult to clean later.
13. A **steam cleaner** is not to be used for cleaning.
14. Users are advised to **avoid any downward pressure** on the microwave door when in the open position. There is a safety risk that the oven will tilt forward.

Maintenance of Your Oven

Service

1. **When your oven requires a service** call your local Panasonic engineer (**Customer Communications Centre** on **0344 844 3899** can recommend an engineer).

Door Seals

2. Do not attempt to tamper with or make any adjustments or repairs to door, control panel housing, safety interlock switches or any other part of the oven. Do not remove outer panel from oven. The door seals and door seal areas should always be kept clean – use a damp cloth.

Oven Light

3. The oven lamp must be replaced by a service technician trained by the manufacturer. **Do not** attempt to remove the outer casing from the oven.

Selected Spares and Accessories

4. These may be ordered direct; on line at www.panasonic.co.uk or by telephoning the **Customer Communications Centre** on **0344 844 3899**. Most major credit and debit cards accepted. Ensure you quote the correct model number.



Warning!

It is hazardous for anyone other than a competent person to carry out any service or repair operation which involves the removal of a cover which gives protection against exposure to microwave energy.

The appliance should be inspected for damage to the door seals and door seal areas. If these areas are damaged the appliance should not be operated until it has been repaired by a service technician trained by the manufacturer.

Parts of Your Oven

1. Do not operate the oven without the roller ring and glass turntable in place.
2. Only use the glass turntable specifically designed for this oven. Do not substitute with any other glass turntable.
3. If glass turntable is hot, allow to cool before cleaning or placing in water.
4. Do not cook directly on glass turntable. Always place food in a microwave safe dish. The only exception to this is when cooking jacket potatoes.
5. If food or utensils on the glass turntable touch the oven walls this will cause the turntable to stop moving. It will then automatically rotate in the opposite direction. This is normal. Open oven door, reposition the food and restart.
6. The glass turntable can rotate in either direction. The maximum weight that can be placed on the turntable is 3 Kg (6 lb 10 oz) (this includes total weight of food and dish).
7. While cooking by **microwave** or **combination** the turntable may vibrate. This will not affect cooking performance.
8. The wire rack must **only** be used as directed for **grilling** and **combination** cooking. Never use this on **microwave** only. **Failure to use accessories correctly could damage your oven.**
9. Arcing may occur if the incorrect weight of food is used, a metal container has been used accidentally, or the wire rack has been damaged. If this occurs, stop the machine immediately.
10. Always refer to instructions for correct accessories to use on all programs. The glass turntable and roller ring are the only accessories used for **microwave** cooking.

Parts of Your Oven

1. Door release

Press to open the door. When you open the oven door during cooking, the cooking is stopped temporarily without clearing earlier made settings. The cooking is resumed as soon as the door is closed and Start button pressed.

2. See-through oven window

3. Door safety lock system

4. Oven air vent

5. Waveguide cover (do not remove)

6. External oven air vents

7. Control panel

8. Power supply cord

9. Plug

10. Identification plate

11. Glass turntable

The glass turntable and roller ring are the only accessories used for Microwave cooking.

12. Roller ring

(i).The Roller ring and oven floor should be cleaned frequently to prevent excessive noise.

(ii).The Roller ring must always be used together with the Glass turntable for cooking.

13. Grill elements

14. Caution label (hot surfaces)

15. Wire rack

16. Menu label

17. Warning label

18. Stopper (irremovable)

The stopper ensures sufficient space at the back of the oven to provide adequate ventilation.

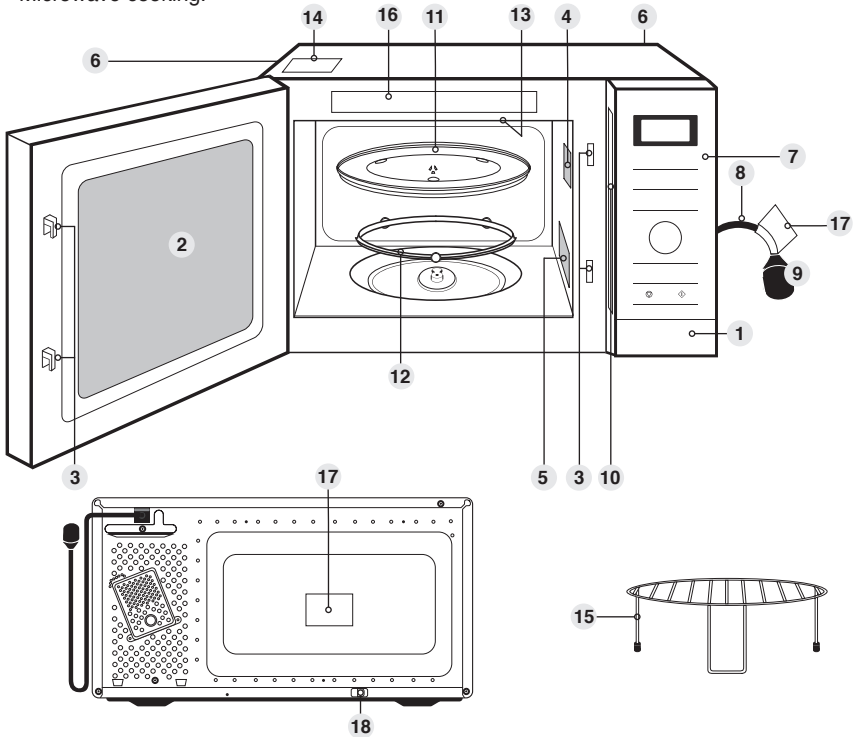

Note

1. The illustration is for reference only.
2. The glass turntable and wire rack are the only accessories with this oven. All other cooking utensils mentioned in this manual must be purchased separately.

Important Information - Read Carefully

Safety

If smoke is emitted or a fire occurs in the oven, press Stop/Cancel button and leave the door closed in order to stifle any flames. Disconnect the power cord, or shut off power at fuse or circuit breaker panel.

Short Cooking Times

As microwave cooking times are much shorter than other cooking methods it is essential that recommended cooking times are not exceeded without first checking the food.

Cooking times given in the cookbook are approximate. Factors that may affect cooking times are: preferred degree of cooking, starting temperature, altitude, volume, size and shape of foods and utensils used. As you become familiar with the oven, you will be able to adjust these factors.

It is better to undercook rather than overcook foods. If food is undercooked, it can always be returned to the oven for further cooking. If food is overcooked, nothing can be done. Always start with minimum cooking times.



Important

If the recommended cooking times are exceeded the food will be spoiled and in extreme circumstances could catch fire and possibly damage the interior of the oven.

Small Quantities of Food

Take care when heating small quantities of food as these can easily burn, dry out or catch fire if cooked too long. Always set short cooking times and check the food frequently.



Note

Never operate the oven without food inside

Foods Low in Moisture

Take care when heating foods low in moisture, e.g. bread items, chocolate, biscuits and pastries. These can easily burn, dry out or catch on fire if cooked too long. We do not recommend heating foods low in moisture such as popcorn or poppadoms. The microwave oven is intended for heating food and beverages only. Drying of food, newspapers or clothing and heating of warming pads, slippers, sponges, damp cloth, wheat bags, hot water bottles and similar may lead to risk of injury, ignition or fire.

Christmas Pudding

Christmas puddings and other foods high in fats or sugar, e.g. jam, mince pies, must not be over heated. These foods must never be left unattended as with over cooking these foods can ignite.

Boiled Eggs

Eggs in their shell and whole hard boiled eggs should not be heated in microwave ovens since they may explode even after microwave heating has ended.

Foods with Skins

Potatoes, apples, egg yolk, whole vegetables and sausages are examples of food with non porous skins. These must be pierced using a fork before cooking to prevent bursting.

Important Information - Read Carefully



Warning!

Liquids and other foods must not be heated in sealed containers since they are liable to explode.

Liquids

When heating liquids, e.g. soup, sauces and beverages in your microwave oven, overheating the liquid beyond boiling point can occur without evidence of bubbling.

This could result in a sudden boil over of the hot liquid. To prevent this possibility the following steps should be taken:

- a. Avoid using straight-sided containers with narrow necks.
- b. Do not overheat.
- c. Stir the liquid before placing the container in the oven and again halfway through the heating time.
- d. After heating, allow to stand in the oven for a short time, stirring again before carefully removing the container.
- e. Microwave heating of beverages can result in delayed eruptive boiling, therefore care should be taken when handling the container.

Lids

Always remove the lids of jars and containers and takeaway food containers before you microwave them. If you don't then steam and pressure might build up inside and cause an explosion even after the microwave cooking has stopped.

Deep Fat Frying

Do not attempt to deep fat fry in your oven.

Meat Thermometer

Use a meat thermometer to check the degree of cooking of joints and poultry only when meat has been removed from the microwave. If undercooked, return to the oven and cook for a few more minutes at the recommended power level. Do not leave a conventional meat thermometer in the oven when microwaving.

Paper & Plastic

When heating food in plastic or paper containers keep an eye on the oven due to the possibility of ignition. Do not use wire twist-ties with roasting bags as arcing will occur. Do not use recycled paper products, e.g. kitchen roll unless they say they are specifically designed for use in a microwave oven. These products contain impurities which may cause sparks and/or fires when used.

Reheating

It is essential that reheated food is served "piping hot". Remove the food from the oven and check that it is "piping hot", i.e. steam is being emitted from all parts and any sauce is bubbling. (If you wish you may choose to check the food has reached 75°C with a food thermometer – but remember do not use this thermometer inside the microwave).

For foods that cannot be stirred, eg lasagne, shepherds pie, the centre should be cut with a knife to test it is well heated through. Even if a manufacturer's packet instructions have been followed always check the food is piping hot before serving and if in doubt return your food to the oven for further heating.

Standing Time

Standing time refers to the period at the end of cooking or reheating when food is left before being eaten, i.e. it is a rest time which allows the heat in the food to continue to conduct to the centre, thus eliminating cold spots.

Keeping your Oven Clean

It is essential for the safe operation of the oven that it is wiped out regularly. Use warm soapy water, squeeze the cloth out well and use to remove any grease or food from the interior. Pay particular attention to the door seal area. The oven should be unplugged when cleaning.

Important Information - Read Carefully

Fan Motor Operation

After using the oven the fan motor may rotate for a few minutes to cool the electric components. This is normal and you can take out food even though the fan motor operates. You can continue using the oven during this time.

Grilling

The oven will only operate on the **grill** function with the door closed.

Babies Bottles and Food Jars

When reheating babies bottles always remove top and teat. Liquid at the top of the bottle will be much hotter than that at the bottom and must be shaken thoroughly before checking the temperature. The lid must also be removed from babies food jars, the contents must also be stirred or shaken before the temperature is checked. This should be carried out before consumption to avoid burns. See page 40.

Arcing

Arcing may occur if a metal container has been used accidentally or if the incorrect weight of food is used or the wire rack has been damaged. Arcing is when blue flashes of light are seen in the microwave oven. If this occurs, stop the machine immediately. If the oven is left unattended and this continues it can damage the machine.

Maximum Weight on Turntable

The maximum weight that can be placed on the turntable is 3 kg (6 lb 10 oz) (this includes total weight of food and dish).

Utensils/Containers

Before use check that utensils / containers are suitable for use in microwave ovens. See pages 23-24.

Storage of Accessories

Do not store any objects inside the oven in case it is accidentally turned on.



Do not operate the oven empty (apart from burning off the oil, see point 4 on page 11). The appliance must not be operated by microwave or combination without food in the oven. Operation when empty will damage the appliance.

Microwaving Principles

Microwaves are present in the atmosphere all the time, both naturally and from manmade sources. Manmade sources include radar, radio, television, telecommunication links and mobile phones.

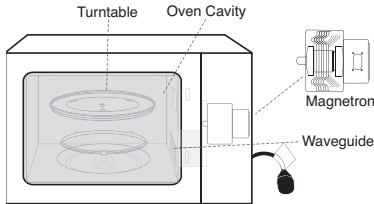

In a microwave oven, electricity is converted into microwaves by the **magnetron**.

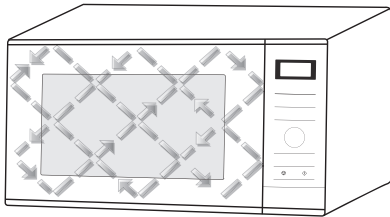

Reflection

The microwaves bounce off the metal walls and the metal door screen.

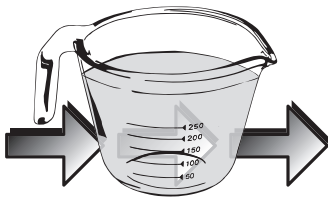

Transmission

Then they pass through the cooking containers to be absorbed by the water molecules in the food, all foods contain water to a more or lesser extent.



Note

The dish used to cook or reheat the food will get warm during cooking, as the heat conducts from the food. Even in microwaving, oven gloves are required!

Microwaves cannot pass through metal and therefore metal cooking utensils can never be used in a microwave, for cooking on microwave only.

How Microwaves Cook Food

The microwaves cause the water molecules to vibrate which causes **friction**, i.e. **heat**. This heat then cooks the food. Microwaves are also attracted to fat and sugar particles, and foods high in these will cook more quickly. Microwaves can only penetrate to a depth of 1½ -2 inches (4-5 cm) and as heat spreads through the food by conduction, just as in a traditional oven, the food cooks from the outside inwards

Foods Not Suitable for Cooking by Microwave Only

Yorkshire Puddings and Souffles. This is because these foods rely on dry external heat to cook correctly, do not attempt to cook by microwave. Foods that require deep fat frying cannot be cooked either.

Standing Time

When a microwave oven is switched off, the food will continue to cook by conduction – **Not by microwave energy, hence standing time** is very important in microwaving, particularly for dense foods i.e. meat, cakes and reheated meals (refer to page 21).



Boiled Eggs

Do not boil eggs in your microwave. Raw eggs boiled in their shells can explode and cause serious injury.

Control Panel - NN-GD38HS

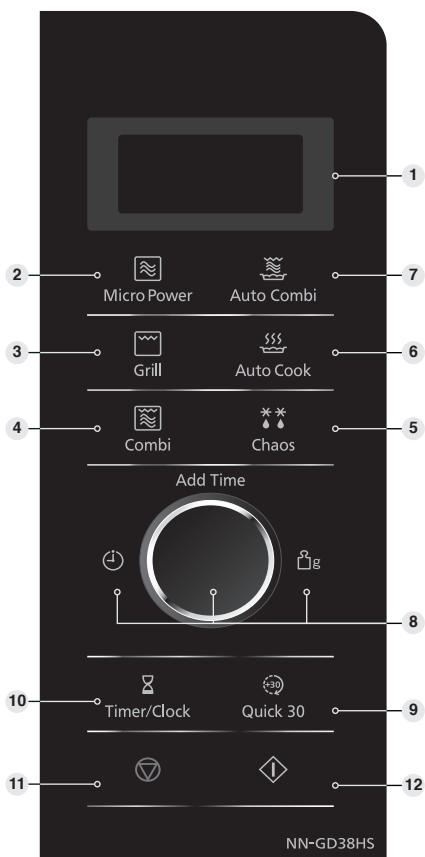

- 1 Display window
- 2 Micro Power button (page 26)
- 3 Grill button (page 31)
- 4 Combi button (page 32)
- 5 Chaos defrost button (page 38-39)
- 6 Auto Cook button (page 35, 37)
- 7 Auto Combi button (page 35-36)
- 8 Dial

Enter time or weight of food by turning the dial. Use the dial for the Add Time function. (page 30)

- 9 Quick 30 button (page 29)
- 10 Timer/Clock button (page 25, 33)
- 11 Stop/Cancel button:

Before cooking:

One press clears your instructions

During cooking: one press temporarily stops the cooking program. Another press cancels all your instructions and the time of day will appear in the display.

- 12 Start button

Press to start operating the oven. If during cooking the door is opened or Stop/Cancel is pressed once, Start has to be pressed again to continue cooking.

This oven is equipped with an energy saving function.



Note

When in stand-by mode the brightness of the display will be reduced. The oven will enter stand-by mode, when first plugged in and immediately after the last operation has completed.

If an operation is set and start button is not pressed, after 6 minutes the oven will automatically cancel the operation. The display will revert back to clock mode.



Beep Sound

When a button is pressed correctly a beep will be heard. If a button is pressed and no beep is heard, the unit has not or cannot accept the instruction. At the end of any complete program, the oven will beep 5 times.

General Guidelines

Standing Time

Dense foods e.g. meat, jacket potatoes and cakes, require a **standing time** (inside or outside of the oven) after cooking, to allow heat to finish conducting to cook the centre completely.

Meat Joints

Stand 15 minutes wrapped in aluminium foil.

Jacket Potato

Stand 5 minutes wrapped in aluminium foil after cooking by microwave only.

Light Cakes

Stand 5 minutes before removing from dish.

Rich Dense Cakes

Stand 15-20 minutes.

Fish

Stand 2-3 minutes.

Egg Dishes

Stand 1-2 minutes.

Precooked Convenience Food

Stand for 1-2 minutes.

Plated Meals

Stand for 2-3 minutes.

Vegetables

Boiled potatoes benefit from standing 1-2 minutes, however most other types of vegetables can be served immediately.

If food is not cooked after **standing time**, return to oven and cook for additional time.

Defrosting

It is essential to allow standing time to complete the process. This can vary from 5 minutes e.g. raspberries, to up to 1 hour for a joint of meat. See pages 27-28.



Piercing

The skin or membrane on some foods will cause steam to build up during cooking.

These foods must be pierced or a strip of skin should be peeled off before cooking to allow the steam to escape.

Eggs, potatoes, apples, sausages etc. will all need to be pierced before cooking.

Do not attempt to boil eggs in their shells.



Moisture Content

Many fresh foods e.g. vegetables and fruit, vary in their moisture content throughout the season. Jacket potatoes are a particular example of this. For this reason cooking times may have to be adjusted throughout the year. Dry ingredients e.g. rice, pasta, can dry out further during storage and cooking times may differ from freshly purchased ingredients.



Cling Film

Cling film helps keep the food moist and the trapped steam assists in speeding up cooking times. Cling film should be pierced before cooking, to allow excess steam to escape. Always take care when removing cling film from a dish as the build-up of steam will be very hot. Always purchase cling film that states on the packet "suitable for microwave cooking" and use as a covering only. Do not line dishes with cling film. Do not cover foods when cooking by combination or grill.

General Guidelines

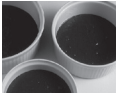

Dish Size

Follow the dish sizes given in the recipes, as these affect the cooking and reheating times. A quantity of food spread in a bigger dish cooks and reheats more quickly.



Quantity

Small quantities cook faster than large quantities, also small meals will reheat more quickly than large portions.



Spacing

Foods cook more quickly and evenly if spaced apart. **Never** pile foods on top of each other.

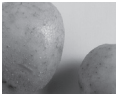

Shape

Even shapes cook evenly. Food cooks better by microwave when in a round container rather than square.

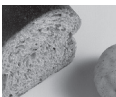

Density

Porous airy foods heat more quickly than dense heavy foods.



Covering

Cover foods with microwave cling film or a self-fitting lid. Cover fish, vegetables, casseroles, soups. Do not cover cakes, sauces, jacket potatoes, pastry items.



Arranging

Individual foods e.g. chicken portions or chops, should be placed on a dish with the thicker parts to the outside.



Starting Temperature

The colder the food, the longer it takes to heat up. Food from a fridge takes longer to reheat than food at room temperature. Food temperature should be between 5-8 °C before cooking.



Turning and Stirring

Some foods require stirring during cooking. Meat and poultry should be turned after half the cooking time.



Liquids

All liquids must be stirred before, during and after heating. Water especially must be stirred before and during heating, to avoid eruption. Do not heat liquids that have previously been boiled. **Do not overheat.**



Checking Food

It is essential that food is checked during and after a recommended cooking time, even if an **auto program** has been used (just as you would check food cooked in a conventional oven). Return the food to the oven for further cooking if necessary.



Cleaning

As microwaves work on food particles, keep your oven clean at all times. Wipe with a soft damp cloth, always wipe the oven dry after cleaning. Avoid any plastic parts, the roof of the oven and door area.

Containers to Use

Choosing the correct container is a very important factor in deciding the success or failure of your cooking.

Testing Dishes for Suitability

When unsure that a cooking container is suitable for use in your microwave, check by the following test:

1. Fill a microwave safe measuring jug with 300 ml (½ pt) cold water.
2. Place it on the turntable alongside the dish to be tested. If the dish you are testing is a large dish, then stand the measuring jug on top of the empty dish.
3. Heat on 1000 W for 1 minute.

Result

If the dish is suitable for microwaving, it will remain cool, whilst the water in the jug will begin to feel warm. If the testing dish feels warm, do not use as it is absorbing microwave energy.



Note

This test does not apply to plastic or metal based containers e.g. Le Creuset® style dishes, which should not be used as they are cast iron covered with enamel.

Quick Check Guide to Cooking Utensils



Oven Glass

Everyday glass that is heat resistant e.g. Pyrex®, is ideal for microwave or combination cooking. Do not use for grilling on the wire rack. Do not use delicate glass or lead crystal which may crack or arc.



China and Ceramic

Everyday glazed china, porcelain or ceramic plates, bowls, mugs and cups can be used if they are heat resistant. Fine bone china should only be used for reheating for short periods. Do not use dishes with a metal rim or pattern. Do not use jugs or mugs with glued handles, since the glue can melt. If dishes are heat resistant they may be used on combination but not directly under the grill.



Pottery, Earthenware, Stoneware

If completely glazed, these dishes are suitable. Do not use if partially glazed or unglazed, since they are able to absorb water which in turn absorbs microwave energy, making the container very hot and slows down the cooking of food.



Foil/Metal Containers

Never attempt to cook in foil or metal containers on microwave only as the microwaves cannot pass through and the food will not heat evenly, it may also damage your oven. Foil and metal containers can be used on **grill** and may be used with care during certain **combination** cooking as long as they are not damaged or dented.

Containers to Use

Plastic

Many plastic containers are designed for microwave use, but do not use for cooking foods high in sugar or fat or for foods that require long cooking times e.g. brown rice. Only use Tupperware® containers if they are designed for microwave use. Do not use Melamine. Never cook in margarine cartons or yoghurt pots, as these will melt with the heat from the food. If heatproof they can be used for combination cooking. Do not use under the grill.

Paper

Plain white absorbent kitchen paper (kitchen towel) can only be used for microwave cooking e.g. covering blind pastry cases and for covering bacon to prevent splattering.

Only use for short cooking times. Never re-use a piece of kitchen towel. Always use a fresh piece of paper for each dish.

Avoid kitchen paper containing manmade fibres.

If you are using branded recycled kitchen towel, check first that it is recommended for microwave use. Do not use waxed or plastic coated cups or plates as the finish may melt.

Greaseproof paper can be used to line the base of dishes and to cover fatty foods e.g. bacon rashers, to stop splattering. White paper plates can be used for **short reheating times**, on Microwave only.

Wicker, Wood, Straw Baskets

Dishes will crack and could ignite. Do not use wooden dishes in your microwave. **Do not use on any cooking mode.**

Cling Film

Microwave cling film can only be used for covering food that is reheated by microwave. It is also useful for covering food to be cooked, but care should be taken to avoid the film being in direct contact with the food e.g. Do not line dishes with cling film. Do not use on any other cooking mode.

Roasting Bags

Roasting bags are useful when slit up one side to tent a joint, for roasting by power and time. Do not use the metal twists supplied, when using microwave or combination.

Aluminium Foil

Small amounts of smooth aluminium foil can be used to **shield** joints of meat during defrosting and cooking by Microwave, as the microwaves cannot pass through the foil, this prevents the parts shielded from overcooking or overdefrosting. Take care that the foil does not touch the sides or roof of the oven, as this may cause arcing and damage your oven.

Setting the Clock

When the oven is first plugged in "88:88" appears in display window.



Press Timer/Clock twice
A colon starts to blink.

Turn dial
Enter the time by turning the dial. The time appears in the display.

Press Timer/Clock
The colon stops blinking. Time of day is now locked into the display.



Note

1. To reset time of day, repeat step 1 through to step 3, as above.
2. The clock will keep the time of day as long as the oven is plugged in and electricity is supplied.
3. This is a 24 hour clock, ie 2pm = 14:00 not 2:00.

Child Lock

Using this system will make the oven controls inoperable; however, the door can be opened. Child lock can be set when the display shows a colon or the time.

To set:



Press Start three times
The time of day will disappear. Actual time will not be lost. 'key icon'  is indicated in the display.

To cancel:



Press Stop/Cancel three times
The time of day will reappear in the display.



Note

To activate child lock, start must be pressed 3 times within a 10 second period.

Microwave Cooking and Defrosting

The glass turntable must always be in position when using the oven.

Press	Level	Wattage
Once	High	1000 W
Twice	Defrost	270 W
3 Times	Medium	600 W
4 Times	Low	440 W
5 Times	Simmer	300 W
6 Times	Warm	100 W

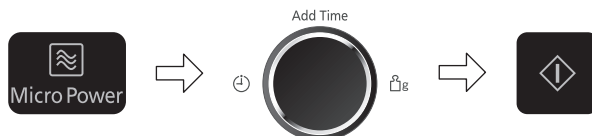

Press Micro Power

Select desired power level. The microwave indicator lights and the wattage appears in the display.

Set time

Select cooking time by turning the dial. Your oven can be programmed for up to 90 minutes on 600 W (Medium power), 440 W (Low power), 300 W (Simmer power), 270 W (Defrost power) and 100 W (Warm power). 1000 W (High power) can be programmed for 30 minutes.

Press Start

The cooking program will start and the time in the display will count down.



Note

1. For defrosting times please refer to defrost chart on page 28.
2. For multi-stage cooking refer to page 34.
3. Stand time can be programmed after Micro Power and time setting. Refer to using the timer page 33.
4. You can change the cooking time during cooking if required. Turn dial to increase or decrease the cooking time. Time can be increased/decreased in 1 minute increments, up to 10 minutes. Turning the dial to zero will end cooking.
5. Do not use metal containers on microwave mode.

Defrosting Guidelines

For Best Results:

1. Place foods in a suitable container. Meat joints and chickens should be placed on an upturned saucer or on a plastic rack if you have one.
2. Check food during defrosting, as foods vary in their defrosting speed.
3. It is not necessary to cover the food.
4. Always turn or stir the food especially when the oven “beeps”. Shield if necessary (see point 6).
5. Minced meat, chops and other small items should be broken up or separated as soon as possible and placed in a single layer.
6. Shielding prevents food cooking. It is essential when defrosting chickens and joints of meat. The outside thaws out first, so protect wings/breast and fat with smooth pieces of aluminium foil secured with cocktail sticks.
7. Allow standing time so that the centre of the food thaws out. (Minimum of 1 hour for joints of meat and whole chickens).



Arrange food in a single layer.



Turn or break up food as soon as possible.



Shield chickens and joints of meat.

Defrosting Chart

The times given below are a guideline only. Always check the progress of the food by opening the oven door and then re-starting. For larger quantities adjust times accordingly. Food should not be covered during defrosting.

Food	Defrosting Time per 450 g (1 lb)	Method	Standing Time
Meat			
Beef/Lamb/Pork joint 450 g (1 lb)	10-15 mins	Place in a suitable dish or on an upturned saucer or use a rack. Turn 3-4 times. Shield.	60 mins
Minced beef 450 g (1 lb)	10-15 mins	Place in a suitable dish. Break up and turn 3-4 times.	30 mins
Chops 450 g (1 lb)	10-15 mins	Place in a suitable dish in a single layer. Turn twice. Shield if necessary.	15-20 mins
Sausages 450 g (1 lb)	10-12 mins	Place in a suitable dish in a single layer. Turn twice. Shield if necessary.	15-20 mins
Bacon rashers	8-10 mins	Place in a suitable dish. Turn and separate twice. Shield if necessary.	10 mins
Stewing steak 450 g (1 lb)	10-15 mins	Place in a suitable dish. Break up frequently.	15 mins
Whole chicken 450 g (1 lb)	8-10 mins	Place in a suitable dish on an upturned saucer or use a rack. Turn 3-4 times. Shield.	60 mins
Chicken portions 450 g (1 lb)	10-15 mins	Place in a suitable dish in a single layer. Turn twice. Shield if necessary.	30 mins
Fish			
Whole 450 g (1 lb)	15-20 mins	Place in a suitable dish. Turn twice. Shield.	15-20 mins
Fillets/Steak 450 g (1 lb)	10-12 mins	Place in a suitable dish. Turn twice, separate and shield if necessary.	15-20 mins
Prawns 450 g (1 lb)	10-12 mins	Place in a suitable dish. Stir twice during defrosting.	10-15 mins
General			
Bread sliced 400 g (14 oz)	4-5 mins	Place on a plate. Separate and rearrange during defrosting.	10-15 mins
Slice of bread 30 g (1 oz)	30 secs - 1 min	Place on a plate.	1-2 mins
Pastry 450 g (1 lb)	4-5 mins	Place on a plate. Turn halfway.	10-15 mins
Soft fruit 450 g (1 lb)	12-14 mins	Place in a suitable dish. Stir twice during defrosting.	10-15 mins

Using the Quick 30 Function

This function allows you to quickly set cooking time in 30 second increments.



Press **Quick 30** to set the desired cooking time (up to 5 minutes). Each press is 30 seconds. Time appears in the display. Power level is pre-set at 1000 W.

Press Start

The cooking will start and the time in the display will count down. At the end of cooking, five beeps will sound.



Note

1. If desired, you can use other power levels. Select desired power level before pressing **Quick 30**.
2. After setting the time by **Quick 30**, you cannot use dial.
3. This function will not operate for 1 minute after manual cooking.

Using the Add Time Function

This feature allows you to add cooking time at the end of previous cooking.

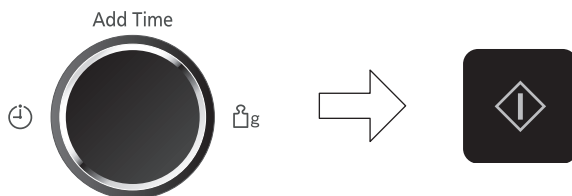

After cooking, turn dial to select Add Time function.

Maximum cooking time:
Microwave: 1000 W up to 30 minutes; other powers up to 90 minutes; Grill, Combination: 90 minutes.

Press Start

Time will be added.
The time in the display window will count down.



Note

1. This function is only available for Micro Power, Grill and Combination function and it is not available for Auto programs.
2. The Add Time function will not operate after 1 minute cooking.
3. The Add Time function can be used after the multi-stage cooking.
4. The power level is the same as the last stage. This function will not operate if the last stage was standing time.

Grilling

The grill system on the oven gives fast efficient cooking for a wide variety of foods e.g. chops, sausages, steaks, toast, etc. There are 3 different grill settings available.

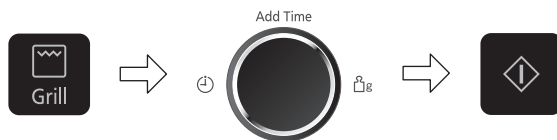

Press Grill to select level.

Press	Power Level
Once	Grill 1 (High)
Twice	Grill 2 (Medium)
3 Times	Grill 3 (Low)

The grill indicator light appears in the display.

Set time

Select Cooking time by turning the dial. Time can be set up to 90 minutes.

Press Start

Adjusting Time During Cooking

You can change the cooking time during cooking if required. Turn dial to increase or decrease the cooking time. Time can be increased/decreased in 1 minute increments, up to 10 minutes. Turning the dial to zero will end cooking.



Note

1. Place food on wire rack on turntable. Place a heatproof plate (Pyrex®) underneath to catch fat and drips.
2. Never cover foods when grilling.
3. **Do not** attempt to preheat the grill.
4. The grill will only operate with the oven door closed. It is not possible to use the grill function with the door open.
5. There is no microwave power on the **grill** only program.
6. Most foods require turning halfway during cooking. When turning food, open oven door and **carefully** remove wire rack using oven gloves.
7. After turning, return food to the oven and close the door. After closing the oven door, press **Start**. The oven display will continue to count down the remaining grilling time. It is quite safe to open the oven door at any time to check the progress of the food as it is grilling.
8. The grill will glow on and off during cooking - this is normal. Always clean the oven after using the grill and before using the microwave or combination.



Caution!

The wire rack must always be used with the glass turntable in position. Remove wire rack from oven by holding the rack and heatproof dish firmly. Use oven gloves when removing accessories. Never touch the outside window or inside metal parts of the door or oven when taking food in or out due to the high temperatures involved.

Combination Cooking

This combination mode is suitable for foods which are normally grilled and for reheating small savoury items. The Grill will glow on and off during cooking - this is normal.



Press Combi

Select combination level.

Set Time

Select cooking time by turning dial. Time can be set up to 90 minutes.

Press Start

Press	Level	MW	Grill
Once	Combi 1	440 W (Low power)	High
Twice	Combi 2	300 W (Simmer power)	High
3 Times	Combi 3	300 W (Simmer power)	Medium

The combination indicator lights, and combination level (1, 2 or 3) will appear in the display.

When cooking by combination, the microwave power cooks food quickly whilst the grill gives traditional browning and crisping.

Adjusting Time During Cooking

You can change the cooking time during cooking if required. Turn dial to increase or decrease the cooking time. Time can be increased/decreased in 1 minute increments, up to 10 minutes. Turning the dial to zero will end cooking.



Note

1. The wire rack is designed to be used for combination and grilling. Never attempt to use any other metal accessory except the one provided with the oven. Place a heatproof dish underneath to catch any fat or drips.
2. Use the wire rack only as described. **Do not** use if operating the oven with less than 200 g (7 oz) of food on a manual program. For small quantities do not cook by **combination**, cook by **grill only** for best results.
3. Never cover foods when cooking on **combination**.
4. **Do not** preheat the grill on **combination**.
5. Arcing may occur if the incorrect weight of food is used, the wire rack has been damaged, or a metal container has been used accidentally. Arcing is flashes of blue light seen in the microwave. If this occurs, stop the oven immediately.
6. Some foods should be cooked on **combination** without using the wire rack i.e. roasts, gratins, pies and puddings. The food should be placed in a heatproof non-metallic dish and placed directly onto the turntable.
7. **Do not use plastic** microwave containers on **combination** programs (unless suitable for combination cooking). Dishes must be able to withstand the heat of the top grill - heatproof glass e.g. Pyrex® or ceramic are ideal. But do not put dishes on wire rack directly under grill.
8. **Do not** use your own metal dishes or tins, as the microwaves will not penetrate the food evenly.



Caution!

The wire rack must always be used with the glass turntable in position. Remove wire rack from oven by holding the rack and heatproof dish firmly. Use oven gloves when removing accessories. Never touch the outside window or inside metal parts of the door or oven when taking food in or out due to the high temperatures involved.

Using the Timer

The timer can be used either before or after a cooking program. This feature can be used to set a standing time after cooking or to delay the start of your cooking.

1. To Set a Standing Time:

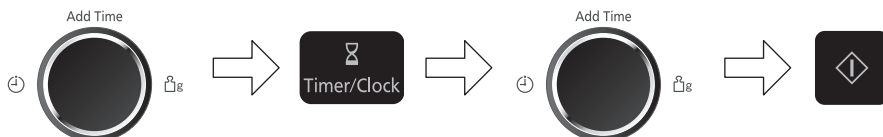

Set the desired cooking program, by selecting power level and time required.

Press Timer/Clock

Set desired standing time using the dial (max 9 hrs).

Press Start
Cooking program will commence after which the standing time will count down.



Note

1. Three stage cooking can be programmed including standing time.
2. If the oven door is opened during the standing time or minute timer, the time in the display window will continue to count down.
3. This feature may also be used as a minute timer. In this case press Timer, set time and press Start.
4. Standing time cannot be programmed after an auto program.
5. If the programmed stand time exceeds one hour, the time will count down in units of minutes. If less than one hour, the time will count down in units of seconds.

2. To Set a Delay Start:

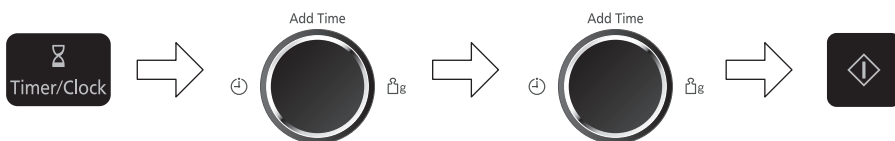

Press Timer/Clock

Set delay time using the dial (max 9 hrs).

Set the complete cooking program, by entering power level and time required.

Press Start
Delayed time will count down then the cooking program will start.



Note

1. Three stage cooking can be programmed including delay start cooking.
2. If the programmed delay time exceeds one hour, the time will count down in units of minutes. If less than one hour, the time will count down in units of seconds.
3. Delay start cannot be programmed before an auto program.
4. If the oven door is opened during the delay time, the time in the display window will continue to count down.

Multistage Cooking

2 or 3 stage cooking

Example:



Example:



Press Micro Power
Select desired power level.

Set the cooking time using the dial.

Press Micro Power
Select desired power level.

Set the cooking time using the dial.

Press Start
The cooking program will start and the time in the display will count down.

Example: To defrost for 2 minutes and cook food on 1000 W for 3 minutes.



Press Micro Power twice to select 270 W.

Set the cooking time to 2 minutes using the dial.

Press Micro Power once to select 1000 W.

Set the cooking time to 3 minutes using the dial.

Press Start

Example: Grill on Grill 3 for 4 minutes and cook food on 440 W for 5 minutes.



Press Grill Power 3 times to select Grill 3.

Set the cooking time to 4 minutes using the dial.

Press Micro Power four times to select 440 W.

Set the cooking time to 5 minutes using the dial.

Press Start



Note

1. For 3 stage cooking, enter another cooking program before pressing Start.
2. During operation, one press on Stop/Cancel stops the operation. You can re-start it by pressing Start. A second press of Stop/Cancel will cancel the selected program.
3. Whilst not operating, one press of Stop/Cancel cancels the selected program.
4. Auto programs cannot be used with multi-stage cooking.

Auto Cook/Combi Programs



Or



This feature allows you to cook foods by setting the weight. The oven determines the microwave power level and/or combination setting, then gives a cooking time; this cooking time has been developed following extensive testing by our Home Economists in our development kitchen.

Select the category of food and enter the weight.

Example



Select Auto Combi

Select the desired program by pressing Auto Cook or Auto Combi. The auto and cooking function indicators light and program number appear in the display.

Set the weight of the food by using the dial.

Turning the dial slowly will count up in 10 g steps. Turning the dial quickly will speed up this process.

Press Start











Note





The Auto programs must **only** be used for foods described. The five food types cooked with Auto Cook, use Micro Power only. The five food types, cooked with Auto Combi, use the microwave and grill together.

1. Only cook foods within the weight ranges described.
2. Always weigh the food rather than relying on the package information.
3. Only use the accessories as indicated on page 36.
4. Do **not** cover food when using the Auto Combi programs as it will prevent the food browning and the heat of the grill will melt any plastic covering.
5. Most foods benefit from a **standing** time, after cooking with an Auto Program, to allow heat to continue conducting to the centre.
6. To allow for some variations that occur in food, check that food is thoroughly cooked and piping hot before serving.

Auto Combi Programs

Program	Weight	Accessory	Instructions
<p>1. Chilled pizza</p>  <p>Auto Combi</p> <p>1 Press</p>	100 g - 300 g		For reheating and browning the top of a purchased chilled pizza. Remove all packaging and place on wire rack on turntable. Select program (1 press of Auto Combi). Enter weight using the dial, then press Start. Do not cover. For best results pizza should be no more than 20 cm (10 inches) in diameter.
<p>2. Frozen pizza</p>  <p>Auto Combi</p> <p>2 Presses</p>	120 g - 440 g		For reheating and browning the top of purchased frozen pizza. Remove all packaging and place on the wire rack on turntable. Select program (2 presses of the Auto Combi). Enter weight using the dial, then press Start. Do not cover. For best results pizza should be no more than 20 cm (10 inches) in diameter.
<p>3. Jacket potatoes</p>  <p>Auto Combi</p> <p>3 Presses</p>	200 g - 1400 g	–	To cook jacket potatoes with a crispier, drier skin. Choose medium sized potatoes 200-250 g (7-9 oz) for best results. Wash and dry potatoes and prick with a fork several times. Place on turntable. Select program (3 presses of Auto Combi). Enter weight using the dial, then press Start. Do not cover.
<p>4. Chilled quiche</p>  <p>Auto Combi</p> <p>4 Presses</p>	150 g - 400 g		For reheating and browning the top of a fresh purchased quiche. Remove all packaging and place on wire rack on turntable. Select program (4 presses of Auto Combi). Enter the weight using the dial, then press Start. Do not cover.
<p>5. Chilled crispy top</p>  <p>Auto Combi</p> <p>5 Presses</p>	300 g - 600 g	–	For reheating and browning chilled purchased savoury dishes eg. Lasagne or Shepherds Pie. Remove any lid or covering. If in a foil container transfer to a similar sized heatproof dish and place on turntable. If using heatproof plastic based dish that food is purchased in, take care and support underneath when removing. Select program (5 presses of Auto Combi). Enter weight using the dial, then press Start. Do not cover.

Auto Cook Programs

Program	Weight	Instructions
6. Chilled meal  1 Press	200 g - 800 g	To reheat a chilled convenience meal that can be stirred. Foods must be in a suitable shallow microwaveable container and have the film pierced. Select program (1 press of Auto Cook), enter weight using the dial and press Start. Stir at the beeps. After cooking allow to stand for 2 minutes. Ensure that the food is piping hot. Stir before serving.
7. Frozen meal  2 Presses	200 g - 500 g	To reheat a frozen convenience meal that can be stirred. Foods must be in a suitable shallow microwaveable container and have the film pierced. Select program (2 presses of Auto Cook), enter weight using the dial, then press Start. Stir at the beeps. After cooking allow to stand for 2 minutes. Ensure that the food is piping hot. Stir before serving.
8. Fresh vegetables  3 Presses	200 g - 800 g	To cook fresh vegetables. Place prepared vegetables into a shallow container on turntable. Add 15 ml (1 tbsp) water per 100 g vegetables. Cover with pierced cling film or lid. Select program (3 presses of Auto Cook), enter weight using the dial, then press Start. Stir at the beeps.
9. Fresh fish  4 Presses	200 g - 800 g	To cook Fresh Fish. Shield the thinner portions. Place in a shallow container on turntable. Add 15 ml - 45 ml (1-3 tbsp) of liquid. Cover with pierced cling film or lid. Select program (4 presses of Auto Cook), enter weight using the dial, then press Start.
10. Rice  5 Presses	100 g - 300 g	For cooking rice for savoury dishes not rice puddings. Rinse the rice thoroughly before cooking. Use a large bowl. Add 2 times boiling water to rice. Add salt if desired. Cover with a lid or pierced cling film. Select program (5 presses of Auto cook). Enter weight and press Start. Stir at the beeps. Allow to stand for 5 minutes after cooking.

Chaos Defrost

This feature allows you to defrost minced meat, chops, chicken portions, meat joints and bread. Press Chaos Defrost to select the correct defrost category and then enter in the weight of the food in grams (see page 39).

Foods should be placed in a suitable dish, whole chickens and joints of meat should be on an upturned saucer or on a microwave safe plate. Chops, chicken portions and slices of bread should be placed in a single layer. It is not necessary to cover the foods.

The **chaos theory** principle is used in auto weight defrost programs to give you a quick and more even defrost. The chaos system uses a random sequence of pulsing microwave energy which speeds up the defrosting process. During the program the oven will beep to remind you to check the food. **It is essential that you turn and stir the food frequently and shield if necessary. On hearing the first beep you should turn and shield (if possible).** On the second beep you should turn the food or break it up.

1st Beep
Turn or Shield



1st Beep
Turn or Shield

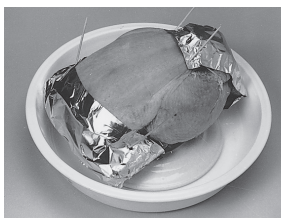

2nd Beep
Turn or break up



Note

1. Check foods during defrosting. Foods vary in their defrosting speed.
2. It is not necessary to cover the food.
3. Always turn or stir the food especially when the oven “beeps”. Shield if necessary (see point 5)
4. Minced meat/chops/chicken portions should be broken up or separated as soon as possible and placed in a single layer.
5. Shielding prevents food cooking. It is essential when defrosting chickens and joints of meat. The outside thaws out first, so protect wings/breast/fat with smooth pieces of aluminium foil secured with cocktail sticks.
6. Allow standing time so that the centre of the food thaws out (minimum 1-2 hours for joints of meat and whole chickens).

Chaos Defrost

With this feature you can defrost frozen foods according to the weight. Select the category and set the weight of the food.

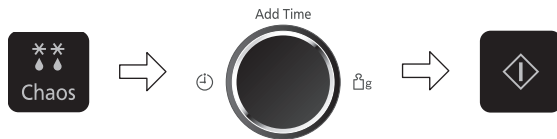

Select desired program

Press Chaos Defrost once to select bread, twice to select meat items and three times to select meat joints. The auto program number and indicators for the Micro Power, Auto Cook and Chaos Defrost appear in the display.

Select the weight of the food by turning the dial.

Turning the dial slowly will count up in 10 g steps. Turning the dial quickly will speed up this process.

Press Start

Remember to stir or turn the food during defrosting.

Program	Weight Range	Suitable Food
11. Bread	100 g - 800 g	Bread and rolls. Turn at beep.
12. Meat Items	150 g - 1000 g	Small pieces of meat, minced meat, chicken portions, steak chops. Turn at beeps and shield.
13. Meat Joints	400 g - 2000 g	Whole chicken, meat joints. Turn at beeps and shield.

1. Bread

This program is suitable for small items which are required for immediate use, they may feel warm straight after defrosting. Loaves can also be defrosted on this program but these will require standing time to allow the centre to thaw out. Standing time can be shortened if slices are separated and buns and loaves cut in half. Items should be turned at beeps. **This program is not suitable for cream cakes or desserts** e.g. cheesecake. Standing time 10-15 minutes.

2. Meat Items (mince/chops/chicken portions)

Not suitable for sausages, these can be defrosted manually. Please refer to defrosting chart on page 28. Chops and chicken portions should be arranged in a single layer and turned at beeps. It is necessary for mince to be broken up at beeps and this is best carried out in a large shallow dish. Standing time 15-30 minutes.

3. Meat Joints / Whole Chickens

Whole chickens and meat joints will require shielding at beeps especially if it is a particularly fatty piece. This is to prevent food starting to cook on the outside edges. Protect wings, breast and fat with smooth pieces of aluminium foil secured with cocktail sticks. **Do not allow the foil to touch the walls of the oven.** Standing time of at least 1 hour should be allowed for joints after defrosting.



Notes

1. The shape and size of the food will determine the maximum weight the oven can accommodate.
2. Allow standing time to ensure the food is completely defrosted.

Cooking and Reheating Guidelines

Most foods reheat very quickly in your oven by **1000 W**. Meals can be brought back to serving temperature in just minutes and will taste freshly cooked. Always check food is piping hot and return to oven if necessary.

As a general rule, always cover wet foods, e.g. soups, casseroles and plated meals.

Do not cover dry foods e.g. bread rolls, mince pies, sausage rolls etc.

The charts on pages 41-47 show you the best way to cook or reheat your favourite foods. The best method depends on the type of food you are cooking or reheating.

Remember to stir or turn food wherever possible during cooking or reheating. This ensures even cooking or reheating on the outside and in the centre.

When is Food Reheated?

Food that has been reheated or cooked should be served "piping hot" i.e. steam should be visibly emitted from all parts. As long as good hygiene practices have been followed during the preparation and storage of the food, then cooking or reheating presents no safety risks.

Foods that cannot be stirred should be cut with a knife to test that they are adequately heated throughout. Even if a manufacturer's Instructions or the times in the cookbook have been followed, it is still important to check the food is heated thoroughly. If in doubt, always return to the oven for further reheating. If you cannot find the equivalent food in the chart then choose a similar type and size listed and adjust the cooking time if necessary.

Plated Meals

Everyone's appetite varies and reheat times depend on meal contents. Dense items e.g. mashed potato, should be spread out well. If a lot of gravy is added, extra time may be required. Place denser items to the outside of the plate.

An average plated meal will take 4-7 minutes on 1000 W to reheat. Do not stack meals.

Canned Foods

Remove foods from can and place in a suitable dish before heating.

Soups

Place soup in a bowl. Stir before heating and at least once during reheat time and again at the end.

Casseroles

Stir halfway through and again at the end of heating.



Caution!

Mince Pies

Remember even if the pastry is cold to the touch, the filling will be piping hot and will warm the pastry through. Take care not to overheat otherwise burning can occur due to the high fat and sugar content of the filling. Check the temperature of the filling before consuming to avoid burning your mouth.

Christmas Puddings and Liquids

Take great care when reheating these items.

Do not leave unattended
Do not add extra alcohol

Babies Bottles

Milk or formula **must** be shaken thoroughly before heating and again at the end and tested carefully before feeding a baby. For 7-8 fl. oz. of milk from fridge temperature, remove top and teat. Heat on 1000 W for 25-30 seconds.

Check carefully.

For 3 fl. oz. of milk from fridge temperature, remove top and teat. Heat on 1000 W for 10-15 seconds. **Check carefully.**

Liquid at the top of bottle will be much hotter than at the bottom. The bottle must be shaken thoroughly and tested before use.

We do not recommend that you use your microwave to sterilise babies' bottles.

If you have a special microwave steriliser we urge extreme caution, due to the low quantity of water involved. It is vital to follow the manufacturers instructions implicitly.

Reheating Charts

The times given in the charts below are a guideline only, and will vary depending on starting temperature, dish size etc.

Heating Category

Your oven is heating Category **E** and this is displayed on the front of your oven door. The information on this label will assist you in using new instructions on food packs to enable you to program the best heating time in your oven.



The IEC (60705) power output (watts)

The heating category for small packs of food

Microwave symbol

Food	Weight/Quantity	Power Level	Time to Select (approx)	Instructions/Guidelines
Bread – Precooked – Fresh – N.B. Breads reheated by Microwave will have a soft base.				
Croissants	2	1000 W	10 - 20 secs	Place on microwave safe plate on turntable. Do not cover. If using grill mode, use heatproof plate.
		or Grill 1	2 - 3 mins	
	4	1000 W	30 or 40 secs	
		or Grill 1	4 mins	
Rolls	1	1000 W	10 - 20 secs	
		or Grill 1	2 - 3 mins	
	4	1000 W	30 - 40 secs	
		or Grill 1	4 - 5 mins	
Canned Beans, Pasta				
Baked Beans, Ravioli in sauce	225 g	1000 W	1 min 30 secs - 2 mins	Place in a microwave safe bowl on turntable. Cover. Stir halfway.
	447 g	1000 W	3 - 3 mins 30 secs	
Spaghetti in tomato sauce	200 g	1000 W	1 min 30 secs	
Canned Soups				
Cream of tomato	400 g	1000 W	2 - 2 mins 30 secs	Place in a microwave safe bowl on turntable. Cover. Stir halfway.
Minestrone	300 g	1000 W	2 mins	
Canned Puddings				
Creamed rice	425 g	1000 W	2 mins	Place in microwave safe bowl on turntable. Cover.
	624 g	1000 W	4 mins	
Sponge pudding	300 g	1000 W	2 mins	
Christmas Puddings- Overheating may cause pudding to ignite				
Slice	150 g	1000 W	30 secs	Place in a microwave safe dish on turntable. Cover.
Small	450 g	1000 W	2 mins	
Medium	900 g	1000 W	3 mins	



Note

Always check that food is piping hot after reheating in the microwave. If unsure return to oven. Foods will still require a stand time, especially if they cannot be stirred. The denser the food the longer the stand time.

Reheating Charts

Food	Weight/ Quantity	Power Level	Time to Select (approx)	Instructions/Guidelines
Drinks - Coffee				
1 mug	235 ml	1000 W	1 - 1 min 30 secs	Place in a microwave safe mug on turntable. Stir, before, during and after reheating.
2 mugs	470 ml	1000 W	2 mins 30 secs	
Drinks – Milk				
1 mug	235 ml	1000 W	1 - 2 mins	Place in a microwave safe mug on turntable. Stir, before, during and after reheating.
1 jug	600 ml	1000 W	4 mins 30 secs - 5 mins	
Pastry Products - Precooked - N.B. Pastries reheated by microwave will have a soft base.				
Cornish pastry	225 g (1)	1000 W	2 - 3 mins	Place on microwave safe plate on turntable. Do not cover. If using Combi mode, use heatproof plate.
		or Combi 2	4 - 5 mins	
Steak & kidney pie	230 g (1)	1000 W	2 mins	
		or Combi 2	5 mins	
Sausage rolls	260 g (4)	1000 W	1 min 30 secs - 2 mins	
		or Combi 2	4 - 5 mins	
Quiche	400 g (1)	1000 W	2 - 3 mins	
		or Combi 2	4 - 6 mins	
Samosas / spring rolls	270 g (4)	1000 W	1 - 1 min 30 secs	
		or Combi 2	5 mins 30 secs - 6 mins	
Christmas mince pies	90 g (2)	1000 W	10 or 20 secs	Place on a microwave safe plate on turntable. Do not cover.
Plated Meals - Homemade - Chilled				
Child size	1	1000 W	2 mins 30 secs	Place on a microwave safe plate on turntable. Cover.
Adult size	1	1000 W	4-6 mins	
Puddings & Desserts N.B. Transfer food from foil containers to a similar sized microwave safe dish				
Bread & butter pudding	400 g	1000 W	3 mins	Place on a microwave safe plate on turntable. Cover.
Fruit crumble	400 g	1000 W	3 - 4 mins	Place in a microwave safe dish on turntable. Do not cover. If using Combi mode, use heatproof dish.
		or Combi 2	8 - 10 mins	
Fruit pie, individual	1	1000 W	20 secs	
		or Combi 2	30 - 50 secs	
	4	1000 W	30 - 40 secs	
		or Combi 2	1 min 30 secs - 2 mins	



Note

Always check that food is piping hot after reheating in the microwave. If unsure return to oven. Foods will still require a stand time, especially if they cannot be stirred. The denser the food the longer the stand time.

Reheating Charts

Food	Weight/ Quantity	Power Level	Time to Select (approx)	Instructions/Guidelines
Purchased Convenience Foods - Chilled				
N.B. Transfer food from foil container to a similar sized microwave safe dish. Plastic dishes designed for microwave and conventional ovens may be used with care.				
Cottage pie	450 g	1000 W	5 - 6 mins	Place in microwave safe dish on turntable. Do not cover. If using Combi mode, use heatproof dish.
		or Combi 2	12 - 15 mins	
Lasagne	400 g	1000 W	7 - 8 mins	
		or Combi 2	10 - 12 mins	
Vegetable bake	400 g	1000 W	6 mins	
		or Combi 2	10 - 11 mins	
Purchased Convenience Foods - Frozen				
N.B. Transfer food from foil container to a similar sized microwave safe dish. Plastic dishes designed for microwave and conventional ovens may be used with care.				
Lasagne	400 g	1000 W	5 min + rest for 1 min	Place in a microwave safe dish on turntable. Do not cover. If using Combi mode use heatproof dish.
		then 1000 W	5 - 6 mins	
		or 1000 W	2 mins	
		then Combi 2	22 mins	
Shepherd's pie	450 g	1000 W	5 mins + rest for 1 min	
		then 1000 W	5 - 6 mins	
		or 1000 W	3 - 4 mins	
		then Combi 2	22 - 25 mins	



Note

Always check that food is piping hot after reheating in the microwave. If unsure return to oven. Foods will still require a stand time, especially if they cannot be stirred. The denser the food the longer the stand time.

Cooking Charts

Food	Weight/ Quantity	Power Level	Time to Select (approx)	Instructions/Guidelines
Bacon - from raw				
Rashers	130 g (4)	1000 W	3 mins 30 secs - 4 mins or 50 - 60 secs per rasher	Place on microwave safe rack or plate on turntable and cover with kitchen towel to minimise splatter.
Beans & Pulses – should be pre-soaked (except lentils)				
Chick peas	225 g	1000 W	8 mins	Use 600 ml (1 pt) boiling water in a large bowl. Cover.
		then 440 W	35-40 mins	
Lentils	225 g	440 W	15 - 20 mins	
Red kidney beans	225 g	1000 W	15 mins	Use 600 ml (1 pt) boiling water in a large bowl. Cover. Must boil for at least 12 minutes to destroy toxic enzymes. Top water up if needed.
		then 440 W	35 - 40 mins	
Beef – Joints from raw – Caution: Hot fat! Remove dish with care.				
Medium		600 W	5 - 8 mins	Place on upturned saucer in flan dish or rack on turntable. Cover and turn halfway. Drain off fat during cooking. Uncover when cooking in Combi mode.
		Then Combi 1	5 - 10 mins per 450 g	
Chicken from raw – Caution: Hot fat! Remove dish with care.				
Breasts, boneless	500 g (4)	440 W	13 - 15 mins	Place on microwave safe rack or plate on turntable. Cover.
		or Combi 2	18 - 19 mins	Place on wire rack with heatproof plate underneath. Turn halfway.
Drumsticks	450 g (4)	440 W	12 - 14 mins	Place on microwave safe rack or plate on turntable. Cover.
		or Combi 2	13 mins	Place on wire rack with heatproof plate underneath. Turn halfway.
		then Grill 1	3 mins	
Quarters	700 g (2)	440 W	18 - 20 mins	Place on microwave safe rack or plate on turntable. Cover.
		or Combi 2	16 - 20 mins	Place on wire rack with heatproof plate underneath. Turn halfway.
Whole		600 W	7 - 8 mins per 450 g (1 lb)	Place on upturned saucer breast side down in microwave safe dish on turntable. Cover, turn over halfway.
		then Combi 1	5 - 10 mins per 450 g (1 lb)	



Note

Always check that food is piping hot after reheating in the microwave. If unsure return to oven. Foods will still require a stand time, especially if they cannot be stirred. The denser the food the longer the stand time.

Cooking Charts

Food	Weight/ Quantity	Power Level	Time to Select (approx)	Instructions/Guidelines
Eggs – Poached				
Water	45 ml	1000 W	50 secs	<ol style="list-style-type: none"> Place water in a small bowl and heat for 1st cooking time. Add egg (medium sized). Pierce yolk and white. Cover. Cook for 2nd cooking time. Then leave to stand for 1 minute.
Egg	1	then 1000 W	40 - 50 secs	
Water	90 ml	1000 W	1 min	
Eggs	2	then 1000 W	1 min 30 secs	
Eggs– Scrambled.				
1 Egg		1000 W	40 secs	<ol style="list-style-type: none"> Add 1 tbsp of milk for each egg used. Beat eggs, milk and knob of butter together. Cook for 1st cooking time then stir. Cook for 2nd cooking time then stand for 1 minute.
		then 1000 W	20 secs	
2 Eggs		1000 W	50 secs - 1 min	
		then 1000 W	40 secs	
Fish – Fresh from raw				
Filletts, Steak, Whole	450 g	1000 W	5 mins	Place in microwave safe dish. Add 30 ml of liquid. Cover.
Fish – Fresh from raw				
Haddock Filletts	380 g (4)	1000 W	8 - 10 mins	Place in microwave safe dish. Add 30 ml of liquid. Cover.
Whole	450 g (2)	1000 W	8 - 10 mins	
Fruit – Peel, slice, chop into even sized pieces. Place in shallow microwave safe dish.				
Apples, Rhubarb, stewed	450 g	1000 W	5 mins	Only half fill dish. Cover.
Plums – stewed	450 g	1000 W	8 - 10 mins	Add 30 ml (2 tbsp) of water. Only half fill dish. Cover.
Lamb – from raw – Caution: Hot Fat! Remove dish with care.				
Chops, loin	600 g	Combi 2	10 mins per 450 g (1 lb)	Place on wire rack with heatproof plate underneath. Turn halfway.
Joints		600 W	10 - 13 mins per 450 g (1 lb)	Place on upturned saucer in microwave safe dish or rack on turntable. Cover and turn joint over halfway. Drain off fat during cooking. Uncover when using Combi mode.
		then Combi 1	5 - 10 mins per 450 g (1 lb)	



Note

Always check that food is piping hot after reheating in the microwave. If unsure return to oven. Foods will still require a stand time, especially if they cannot be stirred. The denser the food the longer the stand time.

Cooking Charts

Food	Weight/ Quantity	Power Level	Time to Select (approx)	Instructions/Guidelines
Pasta – Place in a large 3 litre (6 pint) microwave safe bowl.				
Macaroni	225 g	1000 W	13 - 15 mins	Use 1 litre (1¾ pint) boiling water in a large 2 litres (4 pints) bowl. Cover.
Spaghetti, Tagliatellie	225 g	1000 W	11 - 12 mins	
Pizza – Fresh chilled – N.B. Remove all packaging. Pizzas will have a soft base.				
Thin & Crispy	300 g	1000 W	2 - 3 mins	Place on heatproof plate on turntable. Do not cover.
		or Combi 2	10 - 12 mins	
Deep Pan	450 g	1000 W	3 - 6 mins	Place on heatproof plate on turntable. Do not cover.
		or Combi 2	10 - 12 mins	
Pork – from raw – Caution: Hot Fat! Remove dish with care				
Chops	360 g (2)	1000 W	2 - 3 mins	Place in microwave safe dish or rack on turntable. Cover.
		then 440 W	3 - 5 mins	
		or Combi 2	15 - 18 mins	Place on wire rack with heatproof plate underneath. Turn halfway.
Joints		1000 W	5 - 6 mins per 450 g (1 lb)	Place on upturned saucer in microwave safe dish or rack on turntable. Cover and turn joint over halfway. Drain off fat during cooking.
		then 440 W	8 - 9 mins per 450 g (1 lb)	
Porridge– N.B. Use a large bowl.				
1 serving	½ cup oats	1000 W	2 - 2 mins 30 secs	Add 1 cup of water or milk. Stir halfway.
2 servings	1 cup oats	1000 W	4 - 5 mins	Add 2 cups of water or milk. Stir halfway.
Potato Products Part Cooked - Frozen.				
Croquettes	300 g	Combi 2	12 - 13 mins	Place on wire rack on turntable. Turn halfway.
Waffles	120 g (2)	Grill 1	14 mins	
Rice – Place in a large microwave safe bowl. 3 Litre (6 pint)				
Basmati	250 g	440 W	10 - 14 mins	Use 600 ml (1 pt) boiling water. Cover.
Easycook White	250 g	1000 W	15 - 16 mins	



Note

Always check that food is piping hot after reheating in the microwave. If unsure return to oven. Foods will still require a stand time, especially if they cannot be stirred. The denser the food the longer the stand time.

Cooking Charts

Food	Weight/ Quantity	Power Level	Time to Select (approx)	Instructions/Guidelines
Sausages from raw - Caution: Hot Fat! Remove dish with care.				
Thick	240 g (4)	1000 W	2 - 3 mins	Place on microwave safe plate or microwave rack on turntable. Cover.
		or Combi 2	8 - 10 mins	Place on wire rack with heatproof plate underneath. Turn halfway.
Thin	110 g (4)	1000 W	1 min 30 secs - 2 mins 30 secs	Place on microwave safe plate or microwave rack on turntable. Cover.
		or Grill 1	7 - 8 mins	Place on wire rack with heatproof plate underneath. Turn Halfway.
Fresh Vegetables – Place in shallow microwave safe dish.				
Green beans	200 g	1000 W	4 - 6 mins	Add 15 ml (1 tbsp) water per 100 g of vegetables. Cover.
Beetroot	450 g	1000 W	10 - 12 mins	
Broccoli + cauliflower - florets	450 g	1000 W	8 mins	
Brussel sprouts	300 g	1000 W	8 - 9 mins	
Cabbage – sliced	200 g	1000 W	5 - 6 mins	
Carrots, Leeks	450 g	1000 W	8 - 10 mins	
Corn on the cob	450 g	1000 W	6 - 7 mins	
Courgettes, mange tout	450 g	1000 W	4 - 6 mins	
Peas	450 g	1000 W	5 - 6 mins	
Potatoes – boiled	450 g	1000 W	8 - 9 mins	
Potatoes – jacket (250 g / 9 oz each)	1	1000 W	5 - 6 mins	Wash and prick skins. Place directly on turntable. After cooking stand for 5 minutes wrapped in foil.
	2	1000 W	9 - 10 mins	
Frozen Vegetables – place in shallow microwave safe dish.				
Beans – green, carrots	450 g	1000 W	10 - 11 mins	Add 30 ml (2 tbsp) water. Cover.
Cauliflower	450 g	1000 W	11 - 12 mins	
Peas	450 g	1000 W	8 - 9 mins	



Note

Always check that food is piping hot after reheating in the microwave. If unsure return to oven. Foods will still require a stand time, especially if they cannot be stirred. The denser the food the longer the stand time.

Cream of Mushroom Soup

ingredients

Serves 4

25 g (1 oz) butter
 1 small onion, chopped
 600 ml (1 pt) hot chicken stock
 225 g (8 oz) button mushrooms, sliced
 bouquet garni
 15 ml (1 tbsp) cornflour
 300 ml (½ pt) milk
 salt and pepper
 60 ml (4 tbsp) single cream

Dish: large bowl

1. Place the butter and chopped onion in a large bowl. Cover with pierced cling film and cook on 1000 W for 2-3 minutes or until soft.
2. Add the stock, mushrooms and bouquet garni. Cover and cook on 1000 W for 12-13 minutes or until mushrooms are soft.
3. Remove the bouquet garni and blend until smooth.
4. Mix the cornflour with a little of the milk, then stir in remaining milk.
5. Add to the mushroom mixture.
6. Cover and cook on 1000 W for 5 minutes, or until thickened. Season and serve with cream swirled on top.

Macaroni Cheese with Courgettes and Bacon

ingredients

Serves 2

100 g (4 oz) quick cook macaroni
 225 g (8 oz) courgettes, sliced
 100 g (4 oz) bacon, chopped
 50 g (2 oz) butter
 50 g (2 oz) plain flour
 600 ml (1 pt) milk
 5 ml (1 tsp) mustard
 100 g (4 oz) cheese, grated
 salt and pepper

Topping

30 ml (2 tbsp) Parmesan cheese
 30 ml (2 tbsp) wholemeal breadcrumbs

Dish: 20 cm (8") casserole

1. Cover and cook macaroni in 450 ml (¾ pt) boiling water on 1000 W for 6-8 minutes, or until soft. Drain.
2. Place courgettes and bacon in a bowl. Cover and cook on 1000 W for 3-4 minutes, or until soft. Drain.
3. Place the butter in a large jug. Cook on 1000 W for 20-30 seconds. Stir in the flour and cook for 30 seconds, on 1000 W.
4. Gradually add milk, stir well and cook on 1000 W for approx. 7 minutes, or until the sauce is thick and bubbling. Stir frequently.
5. Add mustard and cheese.
6. Mix in the macaroni, courgettes and bacon.
7. Season and pour into a casserole dish, sprinkle over the topping and cook on combination.
8. Use Combi 2 for 10-11 minutes, or until the cheese has melted.

Lentil Biryani

ingredients

Serves 2

50 g (2 oz) green lentils
 10 ml (2 tsp) oil,
 1 small onion, sliced
 3 ml (½ tsp) grated root ginger
 1 garlic clove, crushed
 3 ml (½ tsp) turmeric
 3 ml (½ tsp) chilli powder
 5 ml (1 tsp) curry powder
 150 ml (¼ pt) natural yoghurt
 50 g (2 oz) mushrooms, sliced
 2 tomatoes, peeled and chopped
 150 ml (¼ pt) hot water
 25 g (1 oz) cashew nuts
 225 g (8 oz) cooked basmati rice

Garnish

hard boiled egg slices and coriander leaves

Dish: large casserole

1. Soak the lentils in cold water for 1 hour then drain. Place the oil and onion in a large bowl. Cover and cook on 1000 W for 2-3 minutes, or until softened.
2. Add the ginger, garlic, turmeric, chilli and curry powder. Cover and cook on 1000 W for 2 minutes.
3. Add the yoghurt, mushrooms, tomatoes, water and lentils. Cover and cook on 1000 W for 15 minutes, or until the lentils are tender and the liquid has evaporated.
4. Add the lentil mixture and cashew nuts to the cooked rice and mix thoroughly.
5. Reheat on 1000 W if necessary to ensure food is piping hot. Garnish and serve.

Lamb in a Spicy Cream and Almond Sauce

ingredients

Serves 4

3-4 garlic cloves, crushed
 1 cm (1/4") piece fresh ginger, grated
 50 g (2 oz) ground almonds
 45 ml (3 tbsp) water
 3 whole cardamom pods
 2 cloves
 2.5 cm (1") stick of cinnamon
 1 onion chopped
 30 ml (2 tbsp) oil
 450 g (1 lb) boned lamb, trimmed and cut into cubes
 5 ml (1 tsp) ground coriander
 5 ml (1 tsp) ground cumin
 1.5 ml (1/4 tsp) garam masala
 1.5 ml (1/4 tsp) cayenne pepper
 150 ml (1/4 pt) single cream
 salt and pepper

Dish: Large
 casserole dish

1. Mix together the garlic, ginger, almonds and water to make a thick paste.
2. Place the cardamom pods, cloves, cinnamon, onion and oil in the casserole dish cook on 1000 W for 2 minutes.
3. Add the lamb and cook for 5 minutes on 1000 W or until light brown in colour. Stir halfway.
4. Stir in the rest of the spices, the almond mixture, cream, salt and pepper.
5. Cover and cook on 440 W for about 40 minutes or until the meat is tender.
6. Stir the casserole 2-3 times during the cooking time.
7. Remove the whole cardamom pods, cloves and cinnamon before serving with rice or other vegetables.

Chicken Casserole

ingredients

Serves 4

25 g (1 oz) butter
 2 medium onions, sliced
 2 sticks celery, trimmed and chopped
 4 chicken quarters, skinned
 300 ml (1/2 pt) hot chicken stock
 296 g (11 oz) can tomatoes
 salt and pepper
 30 ml (2 tbsp) cornflour

Dish: 3 litre (6 pt)
 casserole dish

1. Place butter and vegetables in dish. Cover and cook on 1000 W for 2-4 minutes, or until soft.
2. Place chicken on top of vegetables, cover with stock and tomatoes and add salt and pepper to taste.
3. Cover and cook on 1000 W for 5 minutes, then 440 W for 30-35 minutes, or until well cooked through.
4. Mix cornflour with a little water. Remove chicken from casserole, skim off excess fat and stir in cornflour paste.
5. Cook on 1000 W for 2 minutes. Serve chicken with sauce poured over.

N.B. If diced boneless breast is used in place of the quarters, reduce 2nd cooking time to 12-14 minutes on 440 W or until well cooked through. Stir halfway.

Pork with Sweet & Sour Sauce

ingredients

Serves 2

225 g (8 oz) pork fillet, sliced
Sweet & Sour Sauce:
 15 ml (1 tbsp) oil
 1 small carrot cut into matchsticks
 1 spring onion, thinly sliced
 1 small green pepper, cut into strips
 225 g (8 oz) can pineapple chunks, drained (reserve juice)
 10 ml (2 tsp) soft brown sugar
 5 ml (1 tsp) cornflour
 pinch garlic salt
 5 ml (1 tsp) cider vinegar
 10 ml (2 tsp) soy sauce
 5 ml (1 tsp) tomato ketchup

Dish: Small casserole

1. Place pork in dish, cover and cook on 440 W for 7-9 minutes, or until juices run clear.
2. Place oil, carrot, onion and green pepper in a bowl. Cover and cook on 1000 W for 2 minutes, or until vegetables are tender.
3. Mix half the reserved juice with the remaining ingredients except pineapple. Cover and cook on 1000 W or 1-2 minutes, or until clear and thickened.
4. Stir halfway. Add the sauce to the vegetables. Stir in the pineapple. Mix well.
5. Cook on 1000 W for 2 minutes. Serve chicken with sauce poured over.
6. Spoon over cooked pork. Reheat for 1-2 minutes, on 1000 W or until piping hot.

Savoury Mince

ingredients

Serves 2

1 small onion, diced
 1 clove garlic, crushed
 5 ml (1 tsp) oil
 200 g (7 oz) can chopped tomatoes
 15 ml (1 tbsp) tomato puree
 5 ml (1 tsp) mixed herbs
 225 g (8 oz) minced beef
 salt and pepper

Dish: 1.5 litre (3 pt)
 Casserole dish

1. Place onion, garlic and oil in casserole, cover and cook on 1000 W for 2 minutes, or until soft.
2. Place all other ingredients in casserole. Stir well.
3. Cover and cook on 1000 W for 5 minutes, then 440 W for 10-12 minutes, or until the meat is cooked.

Chicken Satay

ingredients

Serves 2

50 g (2 oz) creamed coconut
 45 ml (3 tbsp) crunchy peanut butter
 45 ml (3 tbsp) lemon juice
 30 ml (2 tbsp) soy sauce
 large pinch of chilli powder
 2 chicken breast fillets, skinned
 15 ml (1 tbsp) vegetable oil
 1 garlic clove, crushed
 3 ml (½ tsp) ground turmeric
 3 ml (½ tsp) five-spice powder
 3 ml (½ tsp) coriander seeds
 3 ml (½ tsp) cumin seeds

Dish: 4 wooden skewers
 + shallow dish

1. **For the serving sauce:** Crumble 25 g (1 oz) of creamed coconut into a large jug.
2. Add the peanut butter, 15 ml (1 tbsp) of the lemon juice, 15 ml (1 tbsp) of the soy sauce, the chilli powder and 150 ml (¼ pt) water.
3. Cook on 1000 W for 3-4 minutes, or until the sauce boils and thickens, stirring frequently. Turn into a serving bowl.
4. Cut the chicken into small chunks and place in a bowl.
5. Put the remaining creamed coconut, lemon juice and soy sauce into a food processor.
6. Add the remaining ingredients and blend until smooth. Pour over the chicken.
7. Cover and marinate in the fridge for 2-3 hours or overnight. Thread the chicken onto wooden skewers.
8. Place in a shallow dish, cover with any remaining marinade and place on wire rack and cook on Combi 2 for 12-14 minutes. Turn halfway.
9. Serve hot with the sauce for dipping.

Fish Curry

ingredients

Serves 2

25 g (1 oz) butter
 1 garlic clove, crushed
 1 small onion, finely chopped
 15 ml (1 tbsp) plain flour
 15 ml (1 tbsp) curry powder
 grated rind and juice of ½ lemon
 300 ml (½ pt) hot fish stock
 25 g (1 oz) sultanas
 10 ml (2 tsp) tomato puree
 30 ml (2 tbsp) sweet chutney
 450 g (1 lb) haddock, skinned and chopped
 salt and pepper
 75 g (3 oz) creamed coconut

Dish: Casserole dish
 (1.5 litre (3 pt))

1. Melt the butter in the casserole dish on 1000 W for 30 seconds, or until melted.
2. Stir in the garlic and onion and cook covered on 1000 W for 2 minutes.
3. Stir in the flour, curry powder, lemon rind and juice and fish stock.
4. Cover and cook on 1000 W for 2-3 minutes, stirring halfway through the cooking time.
5. Stir in the remaining ingredients except the coconut, cover and cook on 1000 W for 4-5 minutes, or until fish flakes, stirring occasionally.
6. Break up the coconut with a fork, then stir into the curry.

Family Fish Pie

ingredients

Serves 4

450 g (1 lb) smoked haddock
 30 ml (2 tbsp) lemon juice
 1 large onion, sliced
 15 ml (1 tbsp) oil
 40 g (1½ oz) butter
 40 g (1½ oz) flour
 3 ml (½ tsp) mustard
 600 ml (1 pt) milk
 salt and pepper
 100 g (4 oz) Red Leicester cheese
 600 g (1 lb 5 oz) cooked jacket potatoes, sliced
 50 g (2 oz) wholemeal breadcrumbs

Dish: large Casserole dish

1. Arrange fish in a shallow dish. Add lemon juice, cover and cook on 1000 W for 3 minutes, or until it flakes easily.
2. Place onion and oil in a bowl. Cover and cook on 1000 W for 2 minutes, or until the onion is soft.
3. Melt the butter on 1000 W for 30 seconds. Stir in the flour and mustard and cook for a further 20 seconds.
4. Add milk and seasoning, gradually stirring to a smooth paste. Cook on 1000 W for 5-6 minutes, or until the sauce is thick and bubbling. Stir twice during cooking. Add 75 g (3 oz) of grated cheese to the sauce and stir well.
5. Flake the fish and arrange in the serving dish. Add onions and place the sliced potatoes on top. Pour over the cheese sauce. Sprinkle with breadcrumbs and remaining cheese.
6. Cook on 440 W for 8-10 minutes, or until the mixture has been completely reheated.
7. Use grill 1 and cook for a further 3-6 minutes, or until brown.

Arranging

Thin fillets of fish i.e. plaice, should be rolled up prior to cooking to avoid overcooking on the thinner outside edge and tail.

Fish steaks should be arranged in a circle, thicker part to the outside. Cover with cling film or lid.

Liquid

Fresh fish should always be sprinkled with 30 ml (2 tbsp) of water, lemon juice or white wine.

When cooking frozen fish, add liquid as above for even cooking. Do not sprinkle salt onto fish before cooking as this may make the fish dry.

Noise

During cooking, popping sounds may be heard. This is due to moisture trapped between the flesh, particularly with oily fish such as salmon and mackerel.

This can be minimised when cooking the fish if the skin and flesh is pierced several times with a cocktail stick.

Wild Mushroom and Basil Risotto

ingredients

Serves 4

40 g (1½ oz) dried Cep mushrooms
50 g (2 oz) butter
1 garlic clove, finely chopped
1 small onion, finely chopped
freshly ground black pepper
250 g (8 oz) Arborio rice
300 ml (½ pt) hot vegetable stock
12 basil leaves, torn
50 g (2 oz) Parmesan cheese, grated

Dish: 3 litre (6 pt) casserole dish

1. Soak mushrooms in 300 ml (½ pt) warm water.
2. Place the butter, garlic and onion in a large bowl, cover with cling film and cook on 1000 W for 2 minutes, or until softened.
3. Season with freshly ground black pepper. Stir the rice into the butter mixture and add the hot stock and soaking liquid from the mushrooms.
4. Cover and cook for a further 5 minutes on 1000 W. Stir the mushrooms into the rice mixture.
5. Cover and cook for a further 5 minutes. on 1000 W. Stir and add the basil.
6. Continue to cook for the final 5 minutes on 1000 W. Stir Parmesan cheese into the risotto mixture.
7. Leave to stand for approx. 10 minutes, and then stir with a fork.

Vegetable Curry

ingredients

Serves 2

15 ml (1 tbsp) oil
1 garlic clove, chopped
pinch cayenne pepper
5 ml (1 tsp) ground coriander
3 ml (½ tsp) ground cumin
3ml (½ tsp) turmeric
2.5 cm (1") root ginger, peeled & sliced
1 medium aubergine, diced
½ small cauliflower, divided into florets
1 medium potato, diced
50 g (2 oz) green beans, sliced
½ fresh chilli, deseeded and sliced
150 ml (¼ pt) vegetable stock
200 g (7 oz) can chopped tomatoes
50 g (2 oz) cashew nuts

Dish: 3 litre (6 pt) casserole

1. Combine oil, garlic and spices in the casserole, cover and cook on 1000 W for 2 minutes.
2. Add all other ingredients to casserole, except cashews.
3. Cover and cook on 1000 W for 5 minutes, then 440 W for 25-35 minutes, or until vegetables are soft.
4. Stir occasionally.
5. Sprinkle with cashews and serve with boiled rice.

Note

This recipe is best cooked in advance, chilled and then reheated to allow the flavours to develop.

Cauliflower Cheese

ingredients

Serves 4

1 cauliflower, trimmed and cut into florets
90 ml (6 tbsp) water
25 g (1 oz) butter
25 g (1 oz) flour
3 ml (½ tsp) French mustard
300 ml (½ pt) milk
seasoning to taste
Topping:
75 g (3 oz) grated red cheese
15 ml (1 tbsp) brown breadcrumbs

Dish: large bowl + shallow casserole

1. Place cauliflower florets in a bowl. Add water.
2. Cover and cook on 1000 W for 8 minutes, or until tender. Drain.
3. Melt butter on 1000 W for 20-30 seconds.
4. Stir in flour and mustard. Cook for a further 20 seconds. Add milk gradually. Stir well and season.
5. Cook on 1000 W for approx. 4 minutes, or until sauce is thick and bubbling. Stir once halfway during cooking.
6. Stir in 50 g (2 oz) grated cheese. Pour the sauce over the cauliflower. Top with remaining cheese and breadcrumbs.
7. Cook on Combi 2 for 7-8 minutes.

Steamed Suet Sponge Pudding

ingredients

Serves 4

150 g (5 oz) self-raising flour
pinch of salt
50 g (2 oz) caster sugar
50 g (2 oz) suet
1 egg
150 ml (¼ pt) milk
30 ml (2 tbsp) jam or golden syrup

Optional:

add 1 tbsp of sultanas to dry ingredients

Dish: 1 litre (2 pt) pudding basin

1. In a mixing bowl, sift together the flour and salt. Stir in the sugar and suet.
2. Make a well in the centre and add beaten egg and milk.
3. Mix to a soft dropping consistency. Put the jam in the base of the greased pudding basin and pour pudding mixture over.
4. Cook on 1000 W for 4-5 minutes, until firm.

Individual Pineapple Upside Down Pudding

ingredients

Serves 2

15 ml (1 tbsp) golden syrup
2 pineapple slices, drained
2 glacé cherries
50 g (2 oz) margarine
50 g (2 oz) caster sugar
1 egg
50 g (2 oz) s

1. Put ½ tbsp golden syrup in the base of each ramekin; arrange pineapple slice and cherry on top of the syrup in the base.
2. Cream together the margarine and sugar until light and fluffy. Beat in the egg gradually.
3. Fold in the flour and mix to a soft consistency with the milk.
4. Spoon the mixture over the pineapple and cook on 1000 W for 3 minutes, or until cooked.
5. Leave to cool slightly before turning upside down onto a serving plate.

Christmas Puddings

ingredients

Serves 4

75 g (3 oz) self-raising flour
3 ml (½ tsp) baking powder
3 ml (½ tsp) mixed spice
25 g (1 oz) butter
1 egg
30 ml (2 tbsp) treacle
60 ml (2 fl. oz) stout
15 ml (1 tbsp) rum or brandy
200 g (7 oz) mincemeat
25 g (1 oz) apple, grated
75 g (3 oz) currants
25 g (1 oz) chopped nuts

Dish: 4 ramekins, base lined

1. Place all ingredients into a large mixing bowl and stir until thoroughly mixed.
2. Divide mixture equally between the ramekins.
3. Place towards outer edge of the turntable and cook on 1000 W for 4-5 minutes, or until cooked.

Date Puddings and Butterscotch Sauce

ingredients

Serves 6

200 g (7 oz) fresh dates, stoned and finely chopped
 175 g (6 oz) self-raising flour
 5 ml (1 tsp) baking powder
 5 ml (1 tsp) vanilla essence
 15 ml (1 tbsp) Camp coffee essence
 100 ml (3½ fl. oz) milk
 75 g (3 oz) butter
 150 g (5 oz) caster sugar
 2 eggs lightly beaten

Butterscotch sauce
 45 g (1¾ oz) butter
 120 ml (8 tbsp) soft brown sugar
 200 ml (7 fl. oz) whipping cream
 15 ml (1 tbsp) vanilla essence

Dish: Individual microwave proof moulds

1. Pour 175 ml (6 fl. oz) boiling water over the chopped dates and set aside to cool. Sift together flour and baking powder.
2. Add vanilla and coffee essence to the milk. Cream the butter and sugar until light and fluffy. Add eggs a little at a time.
3. Fold in the flour and flavoured milk, then pour in the date mixture. Place in six moulds.
4. Cook on 1000 W for 10 minutes and leave to stand for 10 minutes.

Sauce

1. Place butter in a large jug and cook on 1000 W for 50 seconds to 1 minute, or until bubbling.
2. Add sugar and stir until it has dissolved, cooking for 1 minute at a time on 1000 W.
3. Continue to cook until liquid is foaming and bubbling 30 seconds at a time on 1000 W.
4. Slowly pour in the cream and bring to the boil on 1000 W for 2-3 minutes.
5. Add essence. Stir, continue to boil on 1000 W 30 seconds at a time until it starts to thicken.

Chewy Flapjacks

ingredients

Serves 8

75 g (3 oz) butter or margarine
 30 ml (2 tbsp) golden syrup
 75 g (3 oz) light brown sugar
 150 g (5 oz) porridge oats
 50 g (2 oz) raisins

Dish: 20 cm (8") round dish

1. Place butter, syrup and sugar in a bowl and cook on 1000 W for 2-3 minutes, or until melted. Stir halfway.
2. Stir in the oats and raisins. Press into dish. Cook on Combi 2 for 4-5 minutes, or until firm.
3. Allow to cool slightly then cut into 8 pieces.

Boston Brownies

ingredients

Serves 8

100 g (4 oz) plain chocolate
 100 g (4 oz) butter
 100 g (4 oz) soft dark brown sugar
 100 g (4 oz) self-raising flour
 10 ml (2 tsp) cocoa powder
 pinch salt
 2 eggs, beaten
 3 ml (½ tsp) vanilla essence
 100 g (4 oz) walnuts, chopped

Dish: 20 cm (8") square dish lined with greaseproof

1. Place chocolate and butter in a bowl and cook on 1000 W for 1 minute, or until chocolate has melted.
2. Stir in all other ingredients and beat well. Pour into dish and cook on 440 W for 5-6 minute, or until just slightly sticky.
3. Allow to cool and then cut into squares.

Custard

ingredients

Serves 4

30 ml (2 tbsp) custard powder
15 ml (1 tbsp) sugar
600 ml (1 pt) cold milk

Dish: 1 litre (2 pt) jug

1. Mix together the custard powder, sugar and a little milk to form a smooth paste.
2. Blend in the remaining milk, whisking well.
3. Cook on 1000 W for 4-6 minutes.
4. Whisk well halfway through cooking time and again at the end.

White Pouring Sauce

ingredients

Serves 2

30 g (1 oz) butter
30 g (1 oz) flour
600 ml (1 pt) milk

Dish: 1 litre (2 pt) jug

1. Melt butter in jug on 1000 W for 20-30 seconds.
2. Stir in the flour to make a roux. Add the milk gradually stirring continuously until well combined.
3. Cook for 3 minutes on 1000 W.
4. Stir and cook for a further 3-4 minutes. The sauce should be smooth and glossy and coat the back of a spoon.

Soft Fruit Jam

ingredients

Makes approx. 1½ lbs jam

450 g (1 lb) soft fruit, washed
450 g (1 lb) caster sugar
30 ml (2 tbsp) lemon juice
5 ml (1 tsp) butter

Dish: large bowl

1. Place all ingredients in a large bowl and stir.
2. Cook on 1000 W for 5 minutes, (10-15 minutes if using frozen fruit), stir frequently.
3. Continue to cook in one minute intervals until sugar has dissolved. Wash down any sugar crystals from around the bowl.
4. Bring mixture to the boil and continue to cook until setting point is reached – approx. 15-20 minutes.
5. Test regularly for setting point.

N.B. Do not double this mixture as it will boil over.

Questions and Answers

Q: Why won't my oven turn on?

A: When the oven does not turn on, check the following:

1. Is the oven plugged in securely?
Remove the plug from the outlet, wait 10 seconds and reinsert.
2. Check the circuit breaker and the fuse.
Reset the circuit breaker or replace the fuse if it is tripped or blown.
3. If the circuit breaker or fuse is all right, plug another appliance into the outlet.
If the other appliance works, there probably is a problem with the oven. If the other appliance does not work, there probably is a problem with the outlet.

If it seems that there is a problem with the oven, contact an authorised Service Center.

Q: My microwave oven causes interference with my TV. Is this normal?

A: Some radio, TV, Wi-Fi, cordless telephone, baby monitor, blue tooth or other wireless equipment interference might occur when you cook with the microwave oven. This interference is similar to the interference caused by small appliances such as mixers, vacuums, blow dryers, etc. It does not indicate a problem with your oven.

Q: The oven won't accept my program. Why?

A: The oven is designed not to accept an incorrect program. For example, the oven will not accept a fourth stage of cooking.

Q: Sometimes warm air comes from the oven vents. Why?

A: The heat given off from the food whilst cooking warms the air in the oven cavity. This warmed air is carried out of the oven by the air flow pattern in the oven. There are no microwaves in the air. The oven vents should never be blocked during cooking.

Q: Can I use a conventional oven thermometer in the oven?

A: Only when you are using **grill** cooking mode. The metal in some thermometers may cause arcing in your oven and should not be used on **microwave** and **combination** cooking modes.

Q: There are humming and clicking noises from my oven when I cook by **combination**. What is causing these noises?

A: The noises occur as the oven automatically switches from **microwave** power to **grill** to create the combination setting. This is normal.

Q: My oven has an odour and generates smoke when using the **combination** and **grill** function. Why?

A: After repeated use, it is recommended to clean the oven and then run the oven without food, glass tray, and roller ring on grill for 5 minutes. This will burn off any food, residue or oil which may cause an odour and/or smoking.

Q: The oven stops cooking by microwave and 'H97' or 'H98' appears in the display. Why?

A: This display indicates a problem with the microwave generation system. Please contact an authorised Service Centre.

Q: The fan continues to rotate after cooking. Why?

A: After using the oven, the fan motor may rotate to cool the electrical components. This is normal and you can continue using the oven at this time.

Technical Specifications

Manufacturer		Panasonic
Model		NN-GD38HS
Power Supply		230-240 V 50 Hz
Operating Frequency:		2450 MHz
Input Power:	Maximum	2000 W
	Microwave	1050 W
	Grill	1050 W
Output Power:	Microwave	1000 W (IEC-60705)
	Grill	1000W
External Dimensions		488 mm (W) x 395 mm (D) x 279 mm (H)
Interior Dimensions W x D x H (mm)		315 mm (W) x 353 mm (D) x 178 mm (H)
Uncrated Weight (approx.)		10 kg
Noise		57 dB

Weight and Dimensions shown are approximate.

This product is an equipment that fulfills the European standard for EMC disturbances (EMC = Electromagnetic Compatibility) EN 55011. According to this standard this product is an equipment of group 2, class B and is within required limits. Group 2 means that radio-frequency energy is intentionally generated in the form of electromagnetic radiation for purpose of warming or cooking food. Class B means that this product may be used in normal household areas.

Manufactured by: Panasonic Appliances Microwave Oven (Shanghai) Co., Ltd.
888, 898 Longdong Road. Pudong, Shanghai, 201203, China.

Imported by: Panasonic Marketing Europe GmbH

REP. EU: Panasonic Testing Centre
Winsbergring 15, 22525 Hamburg, Germany



Visit Panasonic's **The Ideas Kitchen** website for Microwave advice, recipes, cooking tips and offers:

www.theideaskitchen.co.uk



learn



cook



share

PHONE OUR CUSTOMER COMMUNICATIONS CENTRE

0344 844 3899

For service or spares.

Or order spares direct on line at
www.panasonic.co.uk

Panasonic Corporation
<http://www.panasonic.com>

© Panasonic Corporation 2017

F0003BW60BP
PA0217-0
Printed in P.R.C.