



Panasonic®

Operating Instructions

Bedienungsanleitung

Gebruiksaanwijzing

Mode d'emploi

Manuale di istruzioni

Instrucciones de funcionamiento

Instrukcja obsługi

Návod k obsluze

Kezelési útmutató

Microwave/Grill/Convection Oven

Mikrowellengerät mit Grill/Heißluft

De Panasonic Microgolf/Warme Lucht Oven

Panasonic Four micro-ondes Multifonctions

Forno a microonde e Convezione

Horno Microondas/Convección

Kuchenka mikrofalowa z funkcjami Grill/Konwekcja

Mikrovlinná / Horkovzdušná trouba/ Gril

Grillezős / légkeveréses mikrohullámú sütő

NN-CD565B / NN-CD575M

SLIM COMBI

English

Deutsch

Nederlands

Français

Italiano

Español

Polski

Česky

Magyar



IMPORTANT SAFETY INSTRUCTIONS: Before operating this oven, please read these instructions carefully and keep for future reference.

WICHTIGE SICHERHEITSANWEISUNGEN. Bitte sorgfältig durchlesen und zur weiteren **Bezugnahme aufbewahren.**

BELANGRIJKE VEILIGHEIDSINSTRUCTIES. Lees ze a.u.b. zorgvuldig door en bewaar ze zodat u ze opnieuw kunt raadplegen wanneer nodig.

INSTRUCTIONS DE SÛRETÉ IMPORTANTES. Avant d'utiliser le four à micro-ondes, lisez attentivement les recommandations d'utilisation et conservez-les soigneusement.

ISTRUZIONI IMPORTANTI PER LA SICUREZZA. Leggere attentamente queste note e conservarle per un riferimento futuro.

INSTRUCCIONES SOBRE SEGURIDAD IMPORTANTES. Léalas detenidamente y guárdelas para futura referencia.

WAŻNE INSTRUKCJE BEZPIECZEŃSTWA. Prosimy o dokładne zapoznanie się z instrukcją i zachowanie jej.

DŮLEŽITÉ POKYNY K BEZPEČNOSTI.

Pečlivě si je prosím přečtete a uložte pro příští použití.

FONTOS BIZTONSÁGI TUDNIVALÓK

Kérjük, olvassa el gondosan, és őrizze meg a későbbiekben.

- Important safety instructions. Before operating this oven, please read these instructions carefully and keep for future reference.
- This appliance can be used by children aged from 8 years and above and persons with reduced physical, sensory and mental capabilities or lack of experience and knowledge if they have been given supervision or instruction by a person responsible for their safety concerning the use of the appliance in a safe way and understand the hazards involved. Children shall not play with the appliance. Cleaning and user maintenance shall not be made by children without supervision. Keep the appliance and its cord out of reach of children less than 8 years.
- When this oven is installed, it should be easy to isolate the appliance from the electricity supply by pulling out the plug or operating a circuit breaker.
- If the supply cord is damaged, it must be replaced by the manufacturer or its service agent or a similarly qualified person in order to avoid a hazard.

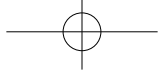

- **Warning!** The appliance should be inspected for damage to the door seals and door seal areas and if these areas are damaged the appliance should not be operated until it has been repaired by a service technician trained by the manufacturer.
- **Warning!** Do not attempt to tamper with or make any adjustments or repairs to the door, control panel housing, safety interlock switches or any other part of the oven. Do not remove the outer panel from the oven which gives protection against exposure to microwave energy. Repairs should only be by a qualified service person.
- Liquids and other foods must not be heated in sealed containers since they are liable to explode.
- **Warning!** Do not place this oven near an electric or gas cooker range.
- **Warning!** Only allow children to use the oven without supervision when adequate instructions have been given so that the child is able to use the oven in a safe way and understands the hazards of improper use.

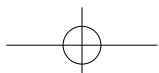

- This oven is intended for counter-top use only. It is not intended for built-in use or for use inside a cupboard.

For Countertop use:

- Oven must be placed on a flat, stable surface 85cm above the floor, with rear of oven placed against a back wall. If one side of the oven is placed flush to a wall, the other side or top must not be blocked. Allow 15cm of space on the top of the oven.
- When heating food in plastic or paper containers, check the oven frequently as these types of containers ignite if overheated.
- If smoke is emitted or a fire occurs in the oven, press Stop/Cancel button and leave the door closed in order to stifle any flames. Disconnect the power cord, or shut off power at fuse or circuit breaker panel.
- When heating liquids, e.g. soup, sauces and beverages in your oven, overheating the liquid beyond boiling point can occur without evidence of bubbling. This could result in a sudden boil over of the hot liquid.

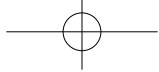

- The contents of feeding bottles and baby food jars are to be stirred or shaken. The temperature has to be checked before consumption to avoid burns.
- Do not cook eggs in their shells and whole hard-boiled eggs by MICROWAVE. Pressure may build up and the eggs may explode, even after the microwave heating has ended.
- Clean the inside of the oven, door seals and door seal areas regularly. When food splatters or spilled liquids adhere to the oven walls, door seals and door seal areas wipe off with a damp cloth. Mild detergent may be used if they get very dirty. The use of harsh detergent or abrasive is not recommended.
- **DO NOT USE COMMERCIAL OVEN CLEANERS.**
- When using the GRILL, CONVECTION or COMBINATION mode, some foods may inevitably splatter grease on to the oven walls. If the oven is not cleaned occasionally, it may start to “smoke” during use.

- Failure to maintain the oven in a clean condition could lead to deterioration of surfaces that could affect the life of the appliance and possibly result in a hazardous situation.
- **Warning!** The accessible parts may become hot in combination use. Young children should be kept away. Children less than 8 years of age should only use the oven under continuous adult supervision due to the temperatures generated.
- A steam cleaner is not to be used for cleaning.
- Do not use harsh, abrasive cleaners or sharp metal scrapers to clean the oven door glass since they can scratch the surface, which may result in shattering of the glass.
- Exterior oven surfaces, including air vents on the cabinet and the oven door will get hot during CONVECTION, COMBINATION and GRILLING, take care when opening or closing the door and when inserting or removing food and accessories.

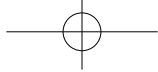

- This appliance is not intended to be operated by means of an external timer or separate remote-control system.
- Only use utensils that are suitable for use in microwave ovens.
- The oven has two quartz heaters situated in the top of the oven. After using the CONVECTION, COMBINATION and GRILL functions, care should be taken to avoid touching the inside surfaces of the oven, as these will be very hot. Care should be taken to avoid the heating element inside the oven.
- The microwave oven is intended for heating food and beverages only. Drying of food, newspapers or clothing and heating of warming pads, slippers, sponges, damp cloth, wheat bags, hot water bottles and similar may lead to risk of injury, ignition or fire.
- Take care when heating foods low in moisture, e.g. bread items, chocolate, biscuits and pastries. These can easily burn, dry out or catch on fire if cooked too long. We do not recommend heating foods low in moisture such as popcorn or poppodums.

Installation and Connection

Examine your microwave oven

Unpack the oven, remove all packing material, and examine the oven for any damage such as dents, broken door latches or cracks in the door. If you find any damage, notify your dealer immediately. Do not install a damaged microwave oven.

Earthing instructions

IMPORTANT: THIS UNIT HAS TO BE PROPERLY EARTHED FOR PERSONAL SAFETY.

If your AC outlet is not grounded, it is the personal responsibility of the customer to have it replaced with a properly grounded wall socket.

Operation voltage

The voltage has to be the same as specified on the label on the oven. If a higher voltage than specified is used, it may cause a fire or other damages.

Placement of the Oven

This oven is intended for counter-top use only. It is not intended for built-in use or for use inside a cupboard.

1. Oven must be placed on a flat, stable surface 85 cm above the floor, with rear of oven placed against a back wall.
2. When this oven is installed, it should be easy to isolate the appliance from the electricity supply by pulling out the plug or operating a circuit breaker.
3. For proper operation, ensure a sufficient air circulation for the oven.

Counter-top use:

If one side of the oven is placed flush to a wall, the other side or top must not be blocked. Allow 15 cm of space on the top of the oven.

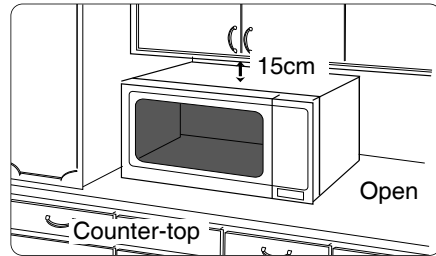

4. Do not place this oven near an electric or gas cooker range.
5. The feet should not be removed.
6. This oven is only for household usage. Do not use outdoors.
7. Avoid using the microwave oven in high humidity.
8. The power cord should not touch the outside of the oven. Keep the cord away from hot surfaces. Do not let the cord hang over the edge of a table or work top. Do not immerse the cord, plug or oven in water.
9. Do not block the air vents on the top and back of the oven. If these openings are blocked during operation the oven may overheat. In this case the oven is protected by a thermal safety device and resumes operation only after cooling down.
10. This appliance is not intended to be operated by means of an external timer or separate remote control system.

Attention: Hot Surfaces



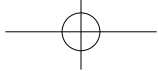

Installation and Connection

WARNING

1. The door seals and seal areas should be cleaned with a damp cloth. The appliance should be inspected for damage to the door seals and door seal areas and if these areas are damaged the appliance should not be operated until it has been repaired by a service technician trained by the manufacturer.
2. Do not attempt to tamper with or make any adjustments or repairs to the door, control panel housing, safety interlock switches or any other part of the oven. Do not remove the outer panel from the oven which gives protection against exposure to microwave energy. **Repairs should only be done by a qualified service person.**
3. Do not operate this appliance if it has a damaged CORD OR PLUG, if it is not working properly, or if it has been damaged or dropped. It is dangerous for anyone other than a service technician trained by the manufacturer to perform repair service.
4. If the supply cord is damaged, it must be replaced by the manufacturer or its service agent or a similarly qualified person in order to avoid a hazard.
5. Only allow children to use the oven without supervision when adequate instructions have been given so that the child is able to use the oven in a safe way and understands the hazards of improper use.
6. Liquids and other foods must not be heated in sealed containers since they are liable to explode.
7. This appliance can be used by children aged from 8 years and above and persons with reduced physical, sensory and mental capabilities or lack of experience and knowledge if they have been given supervision or instruction by a person responsible for their safety concerning the use of the appliance in a safe way and understand the hazards involved. Children shall not play with the appliance. Cleaning and user maintenance shall not be made by children without supervision. Keep the appliance and its cord out of reach of children less than 8 years.

Safety Instructions

Use of your oven

1. Do not use the oven for any reason other than the preparation of food. This oven is specifically designed to heat or cook food. Do not use this oven to heat chemicals or other non-food products.
2. Before use, check that utensils/containers are suitable for use in microwave ovens.
3. Do not attempt to use this microwave oven to dry newspaper, clothing or any other materials. They may catch on fire.
4. When the oven is not being used, do not store any objects other than oven accessories inside the oven in case it is accidentally turned on.
5. The appliance shall not be operated by MICROWAVE or COMBINATION WITHOUT FOOD IN THE OVEN. Operation in this manner may damage the appliance. Exception to this is point 1 under heater operation, pre-heating on convection or pre-heating the panacrunch pan.
6. If smoke is emitted or a fire occurs in the oven, press Stop/Cancel button and leave the door closed in order to stifle any flames. Disconnect the power cord, or shut off power at fuse or circuit breaker panel.

Safety Instructions

Heater Operation

1. Before using CONVECTION, COMBINATION or GRILL function for the first time, wipe excessive oil off in the oven cavity and operate the oven without food and accessories on CONVECTION 220 °C, for 5 minutes. This will allow the oil that is used for rust protection to be burned off. This is the only time the oven is used empty.
2. Exterior oven surfaces, including air vents on the cabinet and the oven door will get hot during CONVECTION, COMBINATION and GRILLING, take care when opening or closing the door and when inserting or removing food and accessories.
3. The oven has two quartz heaters situated in the top of the oven. After using the CONVECTION, COMBINATION and GRILL functions, care should be taken to avoid touching the inside surfaces of the oven, as these will be very hot. Care should be taken to avoid the heating element inside the oven.

N.B. After cooking by these modes, the oven accessories will be very hot.

4. The accessible parts may become hot in combination use. Young children should be kept away. Children less than 8 years of age should only use the oven under continuous adult supervision due to the temperatures generated.

Fan Motor Operation

After using the oven the fan motor may rotate for a few minutes to cool the electric components. This is normal and you can take out food even though the fan motor operates. You can continue using the oven during this time.

Oven Light

When it becomes necessary to replace the oven light, please consult your dealer.

Accessories

The oven comes equipped with a variety of accessories. Always follow the directions given for use of the accessories.

Glass Tray

1. Do not operate the oven without the roller ring and the glass tray in place.
2. Never use another type of glass tray than the one specially designed for this oven.
3. If the glass tray is hot, let it cool before cleaning or placing in water.
4. The glass tray can turn in either direction.
5. If the food or cooking vessel on the glass tray touches the oven walls and stops the tray rotating, the tray will automatically rotate in the opposite direction. This is normal.
6. Do not cook foods directly on the glass tray, except when cooking Jacket Potatoes in microwave mode.

Roller Ring

1. The roller ring and the oven floor should be cleaned frequently to prevent noise and build-up of remaining food.
2. The roller ring must always be used for cooking together with the glass tray.

Enamel Tray

1. The Enamel Tray is for cooking on Grill, Convection and Combination modes. Do not use Enamel Tray in Microwave mode only.
2. The Enamel Tray should be placed on the Glass Tray or Wire Rack.

Wire Rack

1. The wire rack is used to grill small dishes, and help with the circulation of heat.
2. Do not use any metal container directly on the Wire Rack in COMBINATION with MICROWAVE.
3. Do not use the Wire Rack in MICROWAVE mode only.

Panacrunch Pan - See page En-25

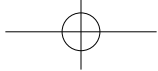

Important Information

1) Cooking Times

- Cooking times given in the cookbook are approximate. The cooking time depends on the condition, temperature, amount of food and on the type of cookware.
- Begin with the minimum cooking time to help prevent overcooking. If the food is not sufficiently cooked you can always cook it for a little longer.

N.B.: If the recommended cooking times are exceeded the food will be spoiled and in extreme circumstances could catch fire and possibly damage the interior of the oven.

2) Small Quantities of Foods

- Small quantities of food or foods with low moisture content can burn, dry out or catch on fire if cooked too long. If materials inside the oven should ignite, keep the oven door closed, turn the oven off and remove the plug from the socket.

3) Eggs

- Do not cook eggs in their shells and whole hard-boiled eggs by MICROWAVE. Pressure may build up and the eggs may explode, even after the microwave heating has ended.

4) Piercing Skin

- Food with non porous skins, such as potatoes, egg yolks and sausages must be pierced before cooking by MICROWAVE to prevent bursting.

5) Meat Thermometer

- Use a meat thermometer to check the degree of cooking of roasts and poultry only when the meat has been removed from the oven. Do not use a conventional meat thermometer when using MICROWAVE or COMBINATION because it may cause sparking.

6) Liquids

When heating liquids, e.g. soup, sauces and beverages in your microwave oven, overheating the liquid beyond boiling point can occur without evidence of bubbling.

This could result in a sudden boil over of the hot liquid. To prevent this possibility the following steps should be taken:

- a) Avoid using straight-sided containers with narrow necks.
- b) Do not overheat.
- c) Stir the liquid before placing the container in the oven and again halfway through the cooking time.
- d) After heating, allow it to stand in the oven for a short time, stir again before carefully removing the container.

7) Paper/Plastic

- When heating food in plastic or paper containers, check the oven frequently as these types of containers ignite if overheated.
- Do not use recycled paper products (e.g. Kitchen Roll) unless the paper product is labelled as safe for microwave oven use. Recycled paper products may contain impurities which may cause sparks and/or fires during use.
- Remove wire twist-ties from roasting bags before placing the bags in the oven.

8) Utensils/Foil

- Only use utensils that are suitable for use in microwave ovens.
- Do not heat any closed cans or bottles because they might explode.
- Metal containers or dishes with metallic trim should not be used during Microwave cooking. Sparking will occur.
- If you use any aluminium foil, meat spikes or metalware the distance between them and the oven walls and door should be at least 2 cm to prevent sparking.

9) Feeding Bottles/Baby Food Jars

- The top and teat or lid must be removed from feeding bottles or baby food jars before placing in the oven.
- The contents of feeding bottles and baby food jars are to be stirred or shaken.
- The temperature has to be checked before consumption to avoid burns.

Outline Diagram

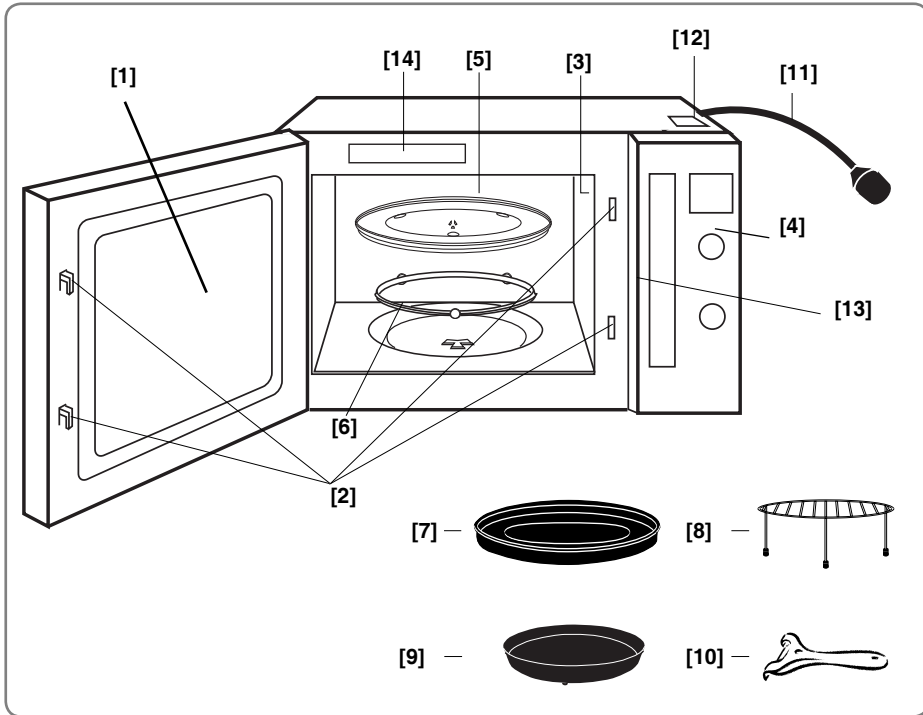

1. Oven Window
2. Door Safety Lock System
3. Oven Air Vent
4. Control Panel
5. Glass Tray
6. Roller Ring
7. Enamel Tray
8. Wire Rack
9. Panacrunch Pan
10. Panacrunch Pan Handle
11. Power Cord
12. Caution Label (Hot Surfaces)
13. Identification Label
14. Position your supplied auto program menu label here.

Control Panel

NN-CD575M / NN-CD565B*

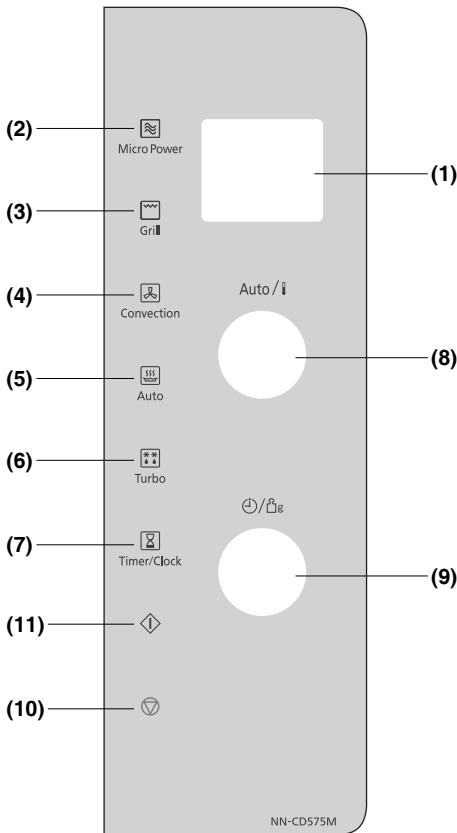

- (1) **Display window**
- (2) **Microwave Power Pad**
- (3) **Grill Power Pad**
- (4) **Convection Power Pad**
- (5) **Auto Weight Programs Pad**
- (6) **Auto Defrost Pad**
- (7) **Timer/Clock Pad**
This can be used to delay a cooking program for up to 9 hrs. or used as a timer or for a standing (non-cooking) time.
- (8) **Auto menu/ temperature/ microwave wattage/ Grill Level/ selector dial.**
- (9) **Time/Weight Dial**
- (10) **Stop/Cancel Pad:**
Before cooking: one press clears your instructions.
During cooking: one press temporarily stops the cooking program. Another press cancels all your instructions and the time of day or colon will appear in the display.
- (11) **Start Button:**
Press to start operating the oven. If during cooking the door is opened or Stop/Cancel Pad is pressed once, Start Pad has to be pressed again to continue cooking.

*The design of your control panel may vary from the panel displayed (depending on colour), but the words on the pads will be the same.





N.B:

If an operation is set and start pad is not pressed, after 6 minutes, the oven will automatically cancel the operation. The display will revert back to colon or clock mode.

Beep Sound: A beep sounds when a pad is pressed. If this beep does not sound, the setting is incorrect. When the oven changes from one function to another, two beeps sound. After completion of cooking, five beeps sound.

Oven Accessories

The following chart shows correct use of the accessories in the oven.

	Glass Tray	Enamel Tray	Wire Rack	Panacrunch
				
Microwave	YES	NO	NO	NO
Grill	YES	YES	YES	YES
Convection	YES	YES	YES	YES
Combination	YES	YES	YES	YES

Cooking Modes

The diagrams shown below are examples of the accessories.

It may vary depending on recipe/dish used. Further information can be found in the Cookbook.

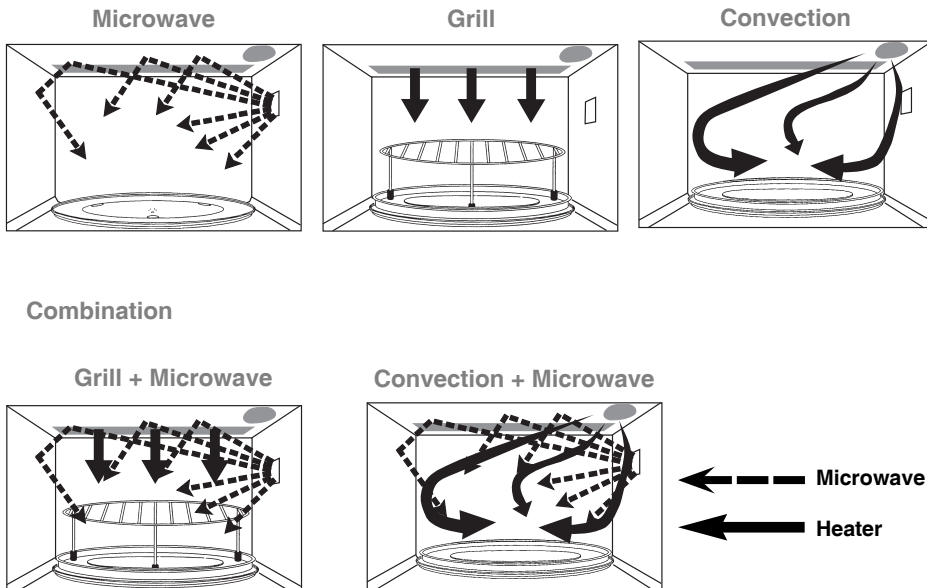

Controls and Operation Procedure

Word Prompting:

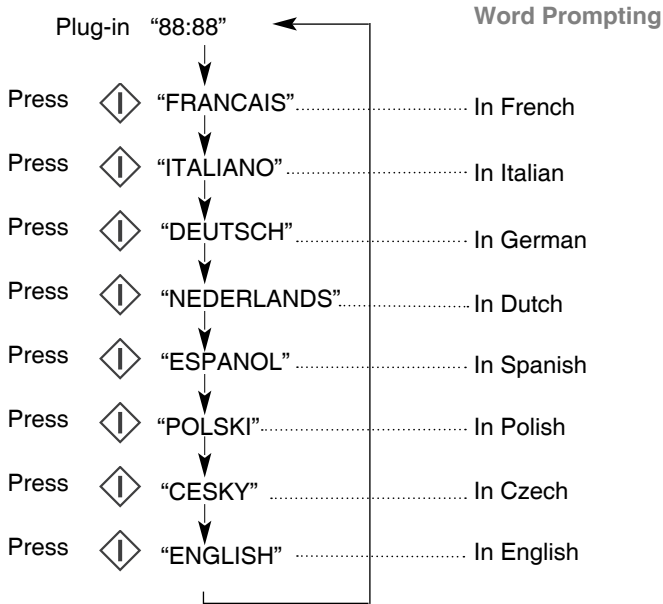

These models have a unique function "Word Prompting" which guides you through the operation of your microwave. After plugging in the oven press the Start Pad until you locate your language. As you press the buttons, the display will scroll the next instruction eliminating the opportunities for mistakes. If for any reason you wish to change the language displayed, unplug the oven and repeat this procedure.

If the Timer Pad is pressed 4 times, this will turn off the operation guide. To turn the operation guide back on, press the Timer Pad 4 times.

Controls and Operation Procedure

English

Clock Setting:

Example: To set 14:25

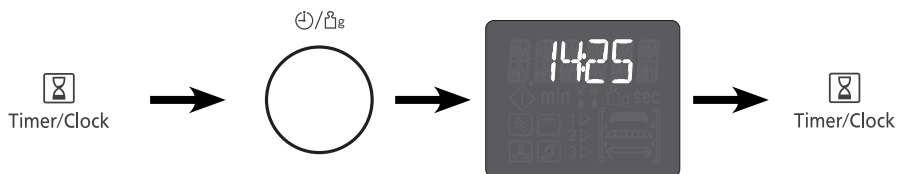

- **Press Timer/Clock Pad twice.**
The colon starts to blink.
- **Enter the time by turning the Time/Weight Dial clockwise.**
The time appears in the display and the colon blinks.
- **Press Timer/Clock Pad once.**
The colon stops blinking and the time of day is entered.

Note:

1. To reset the time of day repeat all the above steps.
2. The time of day is displayed, unless the power supply is interrupted.
3. This clock has a 24 hour display.

Child Safety Lock:

Using this system will make the oven controls inoperable; however, the door can be opened. Child Lock can be set when the display shows a colon or the time.

To Set:  x 3

To Cancel:  x 3

- **Press Start Pad three times.**
The time of day will disappear. Actual time will not be lost. A * is indicated in the display.
- **Press Stop/Cancel Pad three times.**
The time of day will reappear in the display.

NOTE: To activate child lock, start pad must be pressed 3 times within a 10 second period.

Microwave Cooking and Defrost

There are 6 different microwave power levels available. The chart below shows the approximate wattage for each power level.

Accessory to use:

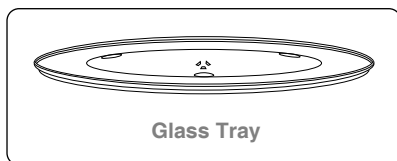

Power Level	Wattage
MAX	1000 W
MIN (DEFROST)	270 W
MEDIUM	600 W
LOW	440 W
SIMMER	250 W
WARM	100 W

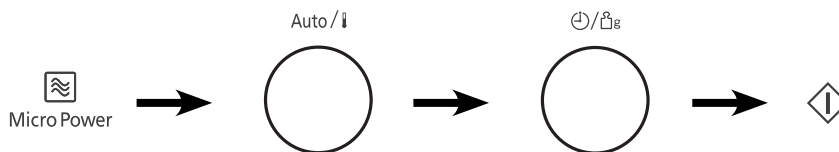

- **Select Microwave power cooking mode.**
- **Select Microwave power level by turning the Auto Menu/ Temperature Dial. The Microwave power level appears in the display.**
- **Set the cooking time using the Time/Weight Dial.**
(30 minutes max power, up to 90 minutes other powers)
- **Press Start Pad.**

Note:

1. For 2 or 3 stage cooking, before pressing Start Pad, repeat setting the Microwave power level and cooking time.
e.g. Casserole — MAX (High) 10 minutes to bring the casserole to boil. 250 W (Simmer) 60 mins. to cook. 100 W (Warm) 10 minutes to allow flavours to develop.
2. Stand time can be programmed after the Microwave power and time setting.
3. You can add to the cooking time during cooking, if required. Turn Time/Weight Dial to increase the cooking time. (Time can be added in 1 minute increments up to maximum time of 10 minutes can be added, only in the case of one stage cooking.)
4. After pressing Start Pad, the selected micro power level can be recalled and changed. Press Micro Power Pad once to indicate the micro power level in the display window. While the level is recalled, you can change it by turning the Auto/Temperature Dial.

CAUTION: The oven will automatically operate on 1000 W Microwave Power if a cooking time is entered without selecting the power level.

Grilling

Accessory to use:

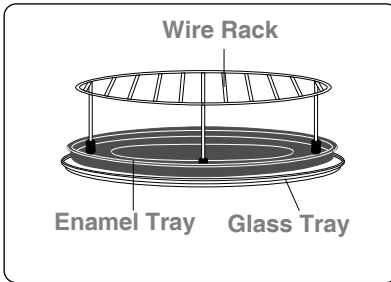

The Grill provides 3 Grill settings.

Power Level	Wattage
1 HIGH	1300 W
2 MEDIUM	950 W
3 LOW	700 W

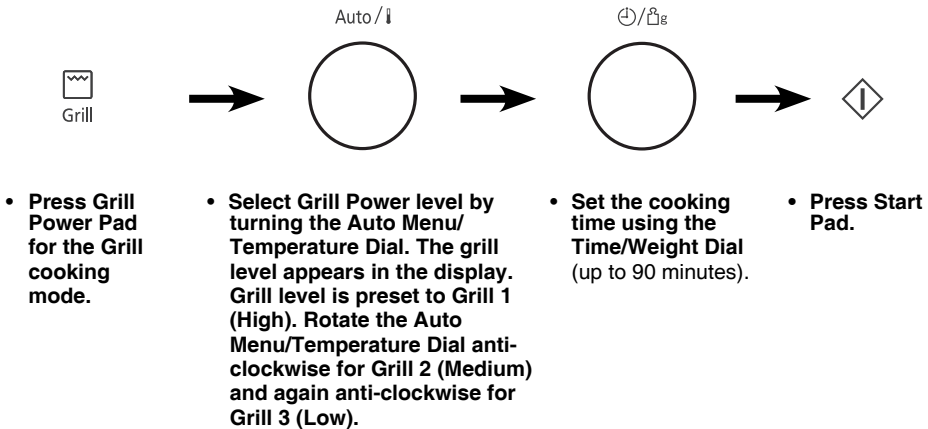

Note:

1. The Grill will only operate with the oven door closed.
2. The Grill cannot be preheated.
3. You can add to the cooking time during cooking, if required. Turn Time/Weight Dial to increase the cooking time. A maximum time of 10 minutes can be added.
4. After pressing Start Pad, the selected grill level can be recalled and changed. Press Grill Pad once to indicate the grill level in the display window. While the level is recalled, you can change it by turning the Auto/Temperature Dial.

Convection Cooking

This feature offers a choice of convection temperatures 100 - 220°C in 10°C increments. For quick selection of the most commonly used cooking temperatures, the temperatures start at 150°C and count up to 220°C by rotating the dial clockwise and count down to 100°C by rotating the dial anti-clockwise.

Accessories to use:

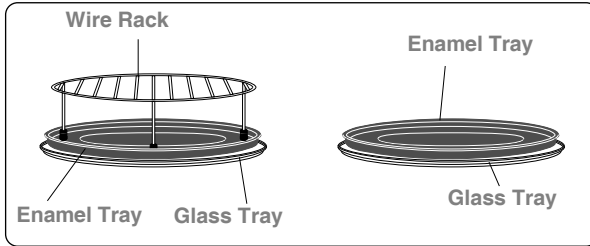

ALWAYS USE OVEN GLOVES WHEN REMOVING THE FOOD AND ACCESSORIES AFTER COOKING AS THE OVEN & ACCESSORIES WILL BE VERY HOT.

Note on preheating

1. Do not open door during preheating. After preheating 3 beeps will be heard and "P" will flash in display window. If oven door is not opened after preheating, oven will maintain the selected temperature. After 30 minutes, oven will shut off automatically and revert to time of day.
2. If you want to cook without preheating, after selecting the desired temperature, set the cooking time then press Start Pad.

Cooking by Convection:

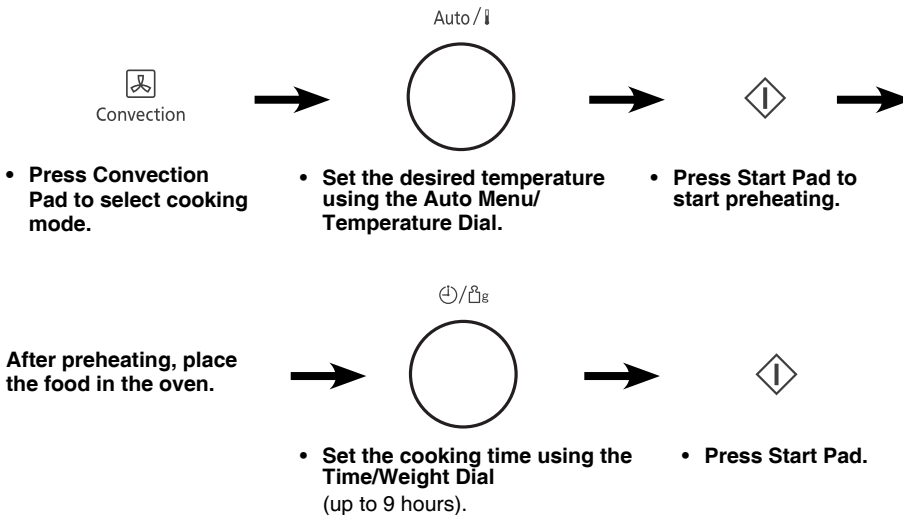

Note:

1. When the selected cooking time is less than one hour, the time counts down second by second.
2. When the selected cooking time is over one hour, the time counts down minute by minute until only "1H 00" (1 hour) remains. The display then indicates minutes and seconds and counts down second by second.
3. You can add to the cooking time during cooking, if required. Turn the Time/Weight Dial to increase the cooking time. Time can be added in 1 minute increments.
4. After pressing Start Pad, the selected temperature can be recalled and changed. Press Convection Pad once to indicate the temperature in the display window. While the temperature is recalled in the display window, you can change the temperature by turning the Auto Menu/ Temperature Dial.

Combination Cooking

There are 2 combination settings:

- 1) Grill 1, 2 or 3 + Microwave 600 W, 440 W, 250 W or 100 W
- 2) Convection 100 - 220°C + Microwave 600 W, 440 W, 250 W or 100 W

Accessories to use:

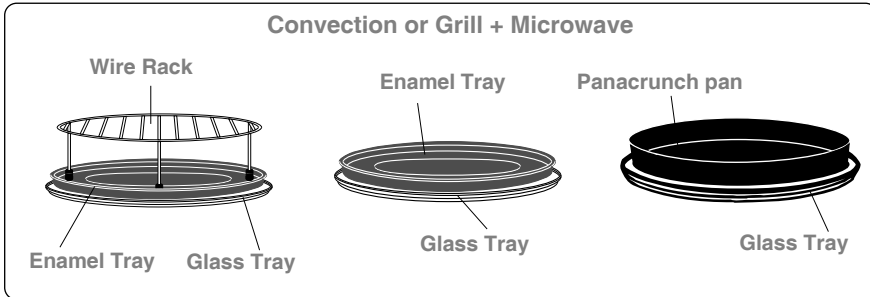

1) Grill + Microwave

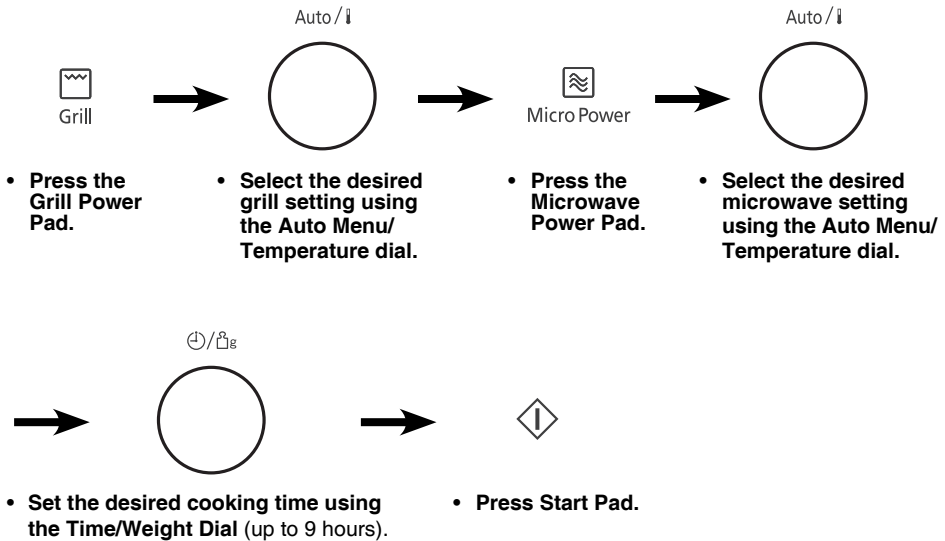

Combination Cooking

2) Convection + Microwave

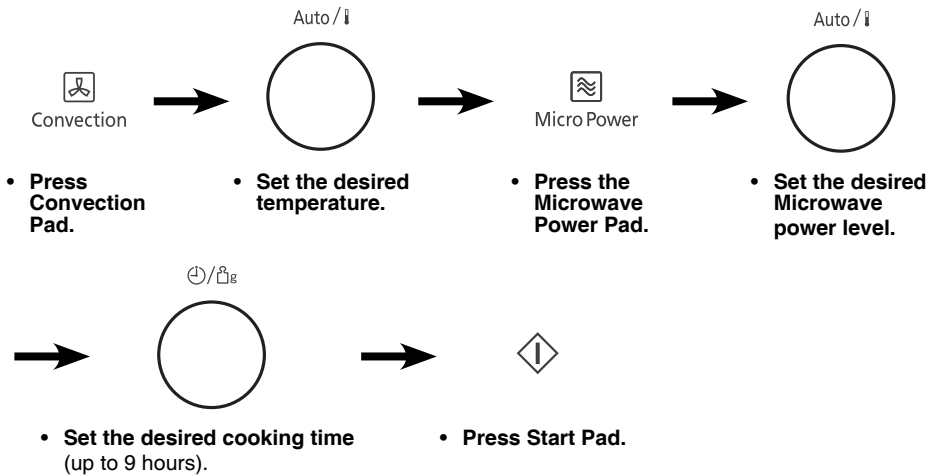

Note on preheating:

1. When using Grill + Microwave mode, preheat is not available.
2. When using Convection + Microwave, the oven can be preheated. Press Start Pad after selecting Microwave power level or Convection temperature. No microwaves are emitted during combination preheating.

Note:

1. When the selected cooking time is less than one hour, the time counts down second by second.
2. When the selected cooking time is over one hour, the time counts down minute by minute until only "1H 00" (1 hour) remains. The display then indicates minutes and seconds and counts down second by second.
3. You can add to the cooking time during cooking, if required. Turn the Time/Weight dial to increase the cooking time. Time can be added in 1 minute increments, up to maximum cooking time.
4. After pressing Start Pad, the selected temperature can be recalled and changed. Press Convection Pad once to indicate the temperature in the display window. While the temperature is recalled in the display window, you can change the temperature by turning the Auto Menu/ Temperature Dial. The grill and microwave levels can not be changed during combination cooking operation.

Auto Defrost

With this feature you can defrost frozen foods according to the weight. Select the category and set the weight of the food. The weight is programmed in grams. For quick selection, the weight starts from the most commonly used weight for each category.

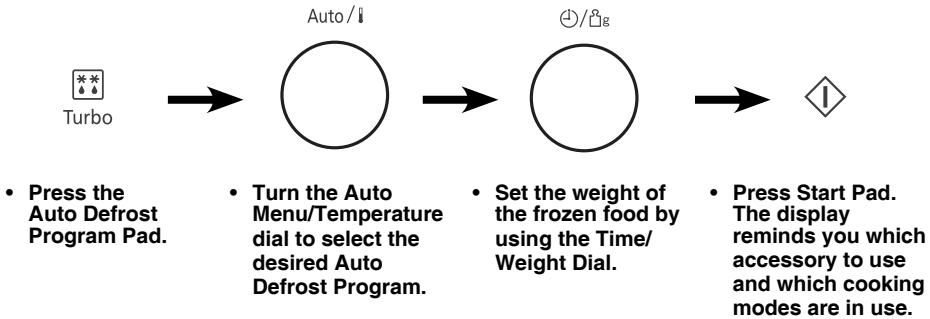

Program Number	Word Prompt	Recommended Weight	Accessories	Suitable Foods
* 1	SMALL PIECES **	120 - 1550 g		Small pieces of meat, escallop, sausages, fish fillets, steaks, chops (each 100 g to 400 g). Turn at beeps.
* 2	BIG PIECE **	400 - 2500 g		Big pieces of meat, roast, whole chicken . Turn at beeps.
* 3	BREAD **	70 - 500 g		For reheating frozen bread, rolls and croissants . Remove all packaging and place on Wire Rack on Enamel Tray on Glass Tray. Turn at beeps.

Note on Program 3

Take care when removing bread and rolls from the oven. The oven and accessories will get hot during/after defrosting.

Note:

1. When defrosting time is over 60 minutes the time will appear in Hours and Minutes.
2. The shape and size of the food will determine the maximum weight the oven can accommodate.
3. For further information see defrosting guidelines in cookbook.

Auto Weight Programs

This feature allows you to cook most of your favourite foods by setting the weight only. The oven determines Microwave power level, Grill power, Convection temperature and cooking time automatically. Select the category and set the weight of the food. The weight is programmed in grams. For quick selection, the weight starts from the most commonly used weight for each category.

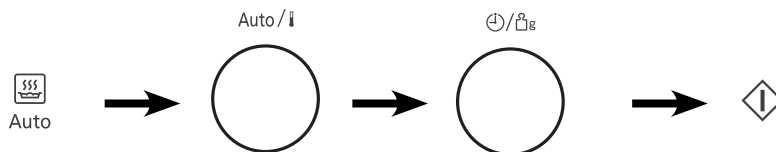

- Press the Auto Weight Program Pad.
- Turn the Auto Menu/Temperature dial to select the desired program.
- Set the weight of food by using the Time/Weight dial.
- Press Start Pad. The display reminds you which accessory to use and which cooking modes are in use.

Note:

1. When cooking time is over 60 minutes, the time will appear as Hours and Minutes.
2. Follow the charts overleaf for the recommended weight and accessories to be used.

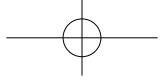

Auto Weight Programs



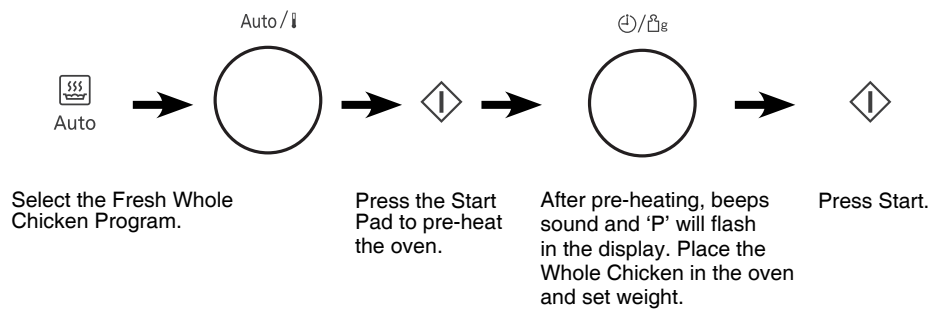

Program Number	Category	Word Prompt	Recommended Weight	Accessories	Instructions
4	Cook Fresh Vegetables	FRESH VEGETABLES	300 - 1500 g		For cooking fresh vegetables. Place the prepared vegetables in a suitable sized container. Sprinkle with 6 tbsp (90 ml) of water. Cover them lightly with pierced cling film or a lid. Large quantities will require stirring at beep.
5	Cook Baked Potatoes	BAKED POTATOES	200 - 1500 g		For cooking baked potatoes with a crisp dry skin. Choose medium sized potatoes 180-300 g for best results. Wash and dry potatoes and prick with a fork several times. Place on Enamel tray on glass tray. Turn at beep.
6	Cook Chicken Pieces	CHICKEN PIECES	150 - 1000 g		For cooking fresh chicken pieces. Place breast side down on Wire Rack on Enamel Tray on Glass Tray. Turn at beep.
7	Cook Fresh Whole Chicken	WHOLE CHICKEN	950 - 2000 g		For cooking a whole chicken. Place on Enamel Tray on Glass Tray. Start cooking breast side down and turn at beep. Cook stuffing separately.

Note:

1. It is necessary to preheat the oven for the Fresh Whole Chicken program. Use the following sequence:



Auto Weight Programs

Program Number	Category	Word Prompt	Recommended Weight	Accessories	Instructions
8	Frozen Pizza	FROZEN PIZZA * * ● ●	150 - 600 g		For reheating, crisping the base and browning the top of frozen purchased pizza. Remove all packaging and place the pizza in the panacrunch pan.
9	Fresh Pizza	CHILLED PIZZA	150 - 600 g		For reheating, crisping the base and browning the top of fresh purchased pizza. Remove all packaging and place the pizza in the panacrunch pan.
10	Frozen Quiche	FROZEN QUICHE * * ● ●	150 - 550 g		For reheating, crisping the pastry base and browning the top of frozen purchased quiche. Remove all packaging and place the quiche in the panacrunch pan.
11	Fresh Feuilletes	PASTRY ITEMS	100 - 600 g		For reheating, crisping and browning fresh feuilletes (pastry items) e.g. friands, feuillète tresse etc. Remove all packaging and place in the panacrunch pan.

Note:

1. It is necessary to preheat the panacrunch pan for the above programs. Use the following sequence.

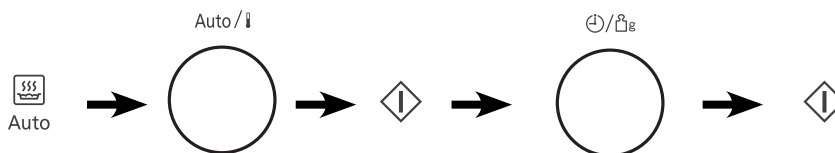

Select the required Program and place the panacrunch pan in the oven, directly on the glass tray.

Press the start Pad to pre-heat the panacrunch pan.

After pre-heating, beeps sound and 'P' will flash in the display. Place the food in the pan, set weight.

Press Start.

Panacrunch Pan

The 'concept'

Some foods cooked by microwave can have soft and soggy crusts. Your panacrunch pan accessory will brown and crisp pizzas, quiches, pies, breaded products. Your Panasonic panacrunch pan works in three ways: heating the pan by absorbing microwaves, heating the food directly by microwaves and heating the food by Grill/Convection. The base of the pan absorbs the microwaves and transfers them into heat. Then the heat is conducted through the pan to the food. The heating effect is maximised by the non-stick surface.

Using the panacrunch pan (Manual operation)

- For best results, pre-heat the pan before using. Place directly on the glass tray and pre-heat on Combination Grill 1 + 600 W for 3 minutes. To assist browning, brush the pan with oil before preheating for items such as sausages and beefburgers.
- Remove the pan from the oven and place the food in the pan. Use the panacrunch pan handle or oven gloves as the pan will be very hot. For best results, it is important that the food is placed on the pan immediately after pre-heating. Performance cannot be guaranteed with a time delay.
- Place the pan on the glass tray and cook according to the guidelines shown in the cooking chart in the cookbook.

Notes:

1. Do not pre-heat the pan more than 8 minutes.
2. Always place the pan in the centre of the glass tray and ensure it does not touch the wall of the oven cavity. Failure to do so may cause sparking which would damage the cavity.
3. Always use the pan on the glass tray. Do not use with the wire rack.
4. Always use the panacrunch pan handle or oven gloves when handling the hot pan.
5. Ensure all food packaging is removed before cooking.
6. Do not place any heat-sensitive materials on the hot pan as this may cause burning.
7. The pan can be used in a conventional oven.
8. For best results, use the pan in COMBINATION GRILL/CONVECTION and MICROWAVE.

Care of the pan

- Never use any sharp utensils on the pan as this will damage the non-stick surface.
- After use, wash the pan in hot soapy water and rinse in hot water. Do not use any abrasive cleaning substances or scouring pads as this will damage the surface of the pan.
- The pan is dishwasher safe.



Delay Start Cooking

By using Timer/Clock Pad, you are able to program Delay Start cooking.

e.g.

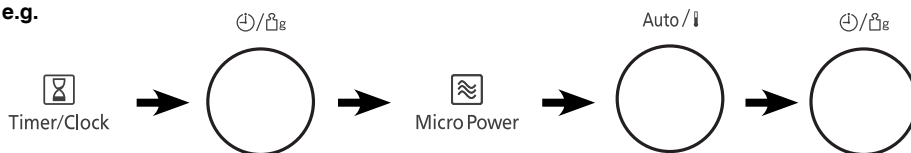

- Press Timer/Clock Pad once.
- Set the delay time by turning Time/Weight Dial (up to 9 hours).
- Set the desired cooking program and cooking time.



- Press Start Pad.

Note:

1. Three stage cooking can be programmed including Delay Start cooking.

e.g.

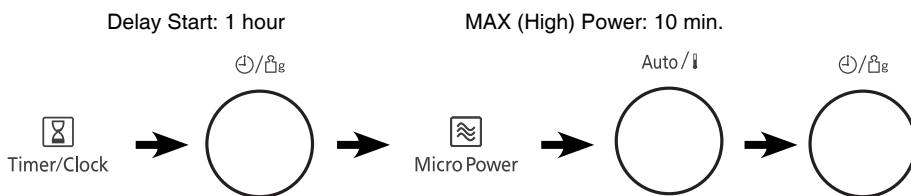

250 W (Simmer) Power: 20 min.

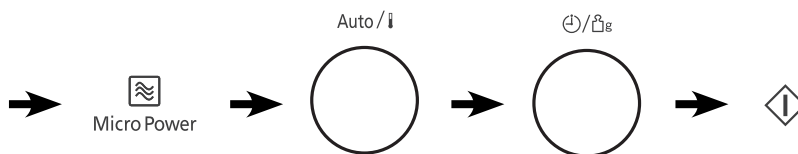

2. If the programmed delay time exceeds one hour, the time will count down in units of minutes. If less than one hour, the time will count down in units of seconds.
3. Delay Start cannot be programmed before any Auto Programs.

Stand Time

By using Timer/Clock Pad, you can program Stand Time after cooking is completed or use to program the oven as a minute timer.

e.g.

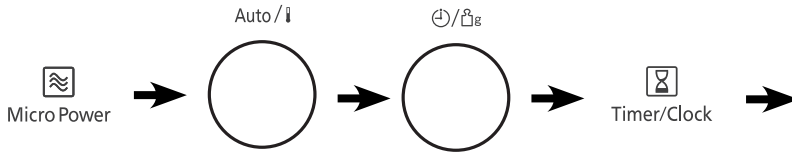

- Set the desired cooking program and cooking time.
- Press Timer/Clock Pad once.

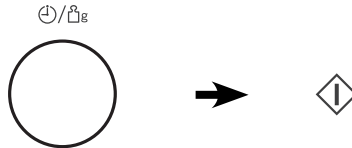

- Set desired amount of time by turning the Time/Weight dial (up to 9 hours).
- Press Start Pad.

Note:

1. Three stage cooking can be programmed including Stand Time.

e.g.

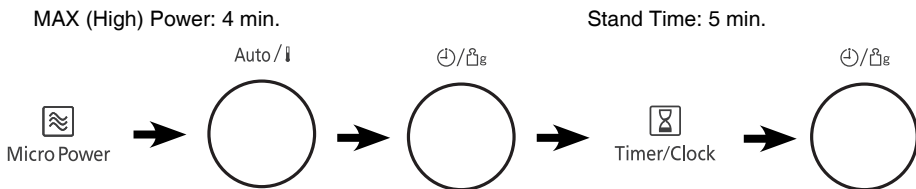

MAX (High) Power: 2 min.

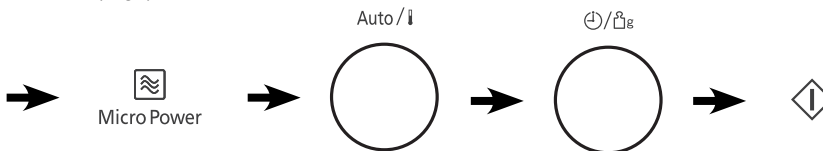

2. If the oven door is opened during the Stand Time or Minute Timer, the time in the display window will continue to count down.
3. This feature may also be used as a timer. In this case press Timer Pad, set time and press Start Pad.

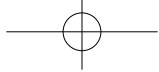

Questions and Answers

- Q:** Why won't my oven turn on?
- A:** When the oven does not turn on, check the following:
1. Is the oven plugged in securely? Remove the plug from the outlet, wait 10 seconds and reinsert.
 2. Check the circuit breaker and the fuse. Reset the circuit breaker or replace the fuse if it is tripped or blown.
 3. If the circuit breaker or fuse is all right, plug another appliance into the outlet. If the other appliance works, there probably is a problem with the oven. If the other appliance does not work, there probably is a problem with the outlet. If it seems that there is a problem with the oven, contact an authorized Service Center.
- Q:** My microwave oven causes interference with my TV. Is this normal?
- A:** Some radio, TV, Wi-Fi, cordless telephone, baby monitor, blue tooth or other wireless equipment interference might occur when you cook with the microwave oven. This interference is similar to the interference caused by small appliances such as mixers, vacuums, blow dryers, etc. It does not indicate a problem with your oven.
- Q:** The oven won't accept my program. Why?
- A:** The oven is designed not to accept an incorrect program. For example, the oven will only accept one stage cooking (excluding Delay Start), and will not accept an Auto Weight Program after Delay Start.
- Q:** Sometimes warm air comes from the oven vents. Why?
- A:** The heat given off from the cooking food warms the air in the oven cavity. This warmed air is carried out of the oven by the air flow pattern in the oven. There are no microwaves in the air. The oven vents should never be blocked during cooking.
- Q:** "D" appears in the display and the oven does not cook. Why?
- A:** The oven has programmed DEMO MODE. This mode is designed for retail store display. Deactivate this mode by pressing Micro Power Pad once and Stop/Cancel Pad four times.
- Q:** Can I use a conventional oven thermometer in the oven?
- A:** Only when you are using CONVECTION/GRILL cooking mode. The metal in some thermometers may cause arcing in your oven and should not be used on MICROWAVE and COMBINATION cooking modes.
- Q:** There are humming and clicking noises from my oven when I cook by COMBINATION. What is causing these noises?
- A:** The noises occur as the oven automatically switches from MICROWAVE power to CONVECTION/GRILL to create the combination setting. This is normal.
- Q:** My oven has an odour and generates smoke when using the CONVECTION, COMBINATION and GRILL function. Why?
- A:** After repeated use, it is recommended to clean the oven and then run the oven without food, glass tray, and roller ring on CONVECTION 220°C for 20 minutes. This will burn off any food, residue or oil which may cause an odour and/or smoking.
- Q:** Can I check the pre-set oven temperature while cooking or preheating by CONVECTION?
- A:** Yes. Press the Convection Temperature Selector pad and the oven temperature will appear in the display window for 2 seconds.
- Q:** Can I easily cook my favourite recipes using CONVECTION/GRILL?
- A:** Yes. You can cook your favourite recipe just as you would in a conventional oven. Check instructions in the Panasonic Cookbook for suggested oven temperatures and cooking times.

Questions and Answers

- Q:** The oven stops cooking by microwave and 'H97' or 'H98' appears in the display. Why?
- A:** This display indicates a problem with the microwave generation system. Please contact an authorised Service Centre.
- Q:** The wordprompt has disappeared on my display, I can only see numbers?
- A:** There may have been a power failure, and the wordprompt is disabled. Unplug the oven for a few seconds, then plug it again. When "88:88" is displayed, press the start pad until your language is displayed. Then set the clock. Refer to page En-14.

Care of Your Oven

1. Turn the oven off before cleaning.
2. Clean the inside of the oven, door seals and door seal areas regularly. When food splatters or spilled liquids adhere to the oven walls, door seals and door seal areas wipe off with a damp cloth. Mild detergent may be used if they get very dirty. The use of harsh detergent or abrasive is not recommended. **DO NOT USE COMMERCIAL OVEN CLEANERS.**
3. Do not use harsh abrasive cleaners or sharp metal scrapers to clean the oven door glass since they can scratch the surface, which may result in shattering of the glass.
4. The outside oven surface should be cleaned with a damp cloth. To prevent damage to the operating parts inside the oven, water should not be allowed to seep into the ventilation openings.
5. If the Control Panel becomes dirty, clean it with a soft, dry cloth. Do not use harsh detergents or abrasives on the Control Panel. When cleaning the Control Panel, leave the oven door open to prevent the oven from accidentally turning on. After cleaning touch STOP/CANCEL Pad to clear the display window.
6. If steam accumulates inside or around the outside of the oven door, wipe with a soft cloth. This may occur when the microwave oven is operated under high humidity conditions and in no way indicates a malfunction of the unit.
7. It is occasionally necessary to remove the glass tray for cleaning. Wash the tray in warm soapy water or in a dishwasher.
8. The roller ring and oven cavity floor should be cleaned regularly to avoid excessive noise. Simply wipe the bottom surface of the oven with mild detergent and hot water then dry with a clean cloth. The roller ring may be washed in mild soapy water. Cooking vapours collect during repeated use but in no way affects the bottom surface or roller ring wheels. After removing the roller ring from the cavity floor for cleaning, be sure to replace it in the proper position.
9. When using the GRILL, CONVECTION or COMBINATION mode, some foods may inevitably splatter grease on to the oven walls. If the oven is not cleaned occasionally, it may start to "smoke" during use.
10. A steam cleaner must not be used for cleaning.
11. This oven should only be serviced by qualified personnel. For maintenance and repair of the oven contact the nearest authorized dealer.
12. Failure to maintain the oven in a clean condition could lead to deterioration of surfaces that could affect the life of the appliance and possibly result in a hazardous situation.
13. Keep air vents clear at all times. Check that no dust or other material is blocking any of the air vents on the top, bottom or rear of the oven. If air vents become blocked this could cause overheating which would affect the operation of the oven and possibly result in a hazardous situation.

Technical Specifications

Power Source:	230 V, 50 Hz	
Power Consumption:	Maximum;	2400 W
	Microwave;	1260 W
	Grill;	1360 W
	Convection;	1380 W
Output:	Microwave;	1000 W (IEC-60705)
	Grill;	1300 W
	Convection;	1300 W
Outside Dimensions:	520 (W) x 395 (D) x 310 (H) mm	
Oven Cavity Dimensions:	359 (W) x 352 (D) x 217 (H) mm	
Weight:	14.2 kg	
Noise:	50 dB	

Specifications subject to change without notice.

This product is an equipment that fulfills the European standard for EMC disturbances (EMC = Electromagnetic Compatibility) EN 55011. According to this standard this product is an equipment of group 2, class B and is within required limits. Group 2 means that radio-frequency energy is intentionally generated in the form of electromagnetic radiation for warming and cooking of food. Class B means that this product may be used in normal household areas.

Information on Disposal for Users of Waste Electrical & Electronic Equipment (private households)



This symbol on the products and/or accompanying documents means that used electrical and electronic products should not be mixed with general household waste.

For proper treatment, recovery and recycling, please take these products to designated collection points, where they will be accepted on a free of charge basis. Alternatively, in some countries you may be able to return your products to your local retailer upon the purchase of an equivalent new product.

Disposing of this product correctly will help to save valuable resources and prevent any potential negative effects on human health and the environment which could otherwise arise from inappropriate waste handling. Please contact your local authority for further details of your nearest designated collection point. Penalties may be applicable for incorrect disposal of this waste, in accordance with national legislation.

For business users in the European Union

If you wish to discard electrical and electronic equipment, please contact your dealer or supplier for further information.

Information on Disposal in other Countries outside the European Union

This symbol is only valid in the European Union.

If you wish to discard this product, please contact your local authorities or dealer and ask for the correct method of disposal.

Manufactured by: Panasonic Appliances Microwave Oven (Shanghai) Co.,Ltd,
888, 898 Longdong Road, Pudong, Shanghai, 201203, China.

Imported by: Panasonic Marketing Europe GmbH

Contact: Panasonic Testing Centre
Winsbergring 15, 22525 Hamburg, Germany.

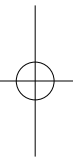
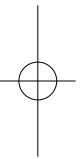
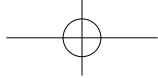

Panasonic Corporation

Website:<http://www.panasonic.com>

© Panasonic Corporation 2015

F0003BS30EP
PA0415-0
Printed in China

